



VHM-Fräswerkzeuge **Solid Carbide Mills**

2018/2019





Die neuen Kataloge von HORN – Maßstäbe für Ihre Produktivität

Unsere Werkzeuge bieten Ihnen von der Einzelteil- bis zur Serienfertigung, bei Standard- oder Sonderanwendungen, schnelle, wirtschaftliche und qualitativ hochwertige Lösungen.

Die Welt unserer Zerspanung mit Standardwerkzeugen haben wir jetzt in den neuen Katalogen

- Stechdrehen
- Supermini und Mini Innenbearbeitung
- Modulare Haltersysteme
- Hochharte Schneidstoffe
- Frässysteme
- Bohren und Reiben
- VHM-Fräswerkzeuge
- Boehlerit Drehen
- Boehlerit Fräsen

zusammengefasst. In jedem Katalog erleichtert Ihnen die Gliederung in typenbezogene Arbeitsverfahren das schnelle Auffinden der bestellgerecht beschriebenen Produkte. Bei der Wahl der individuellen Schnittparameter unterstützen Sie zahlreiche Tabellen mit praxis-erprobten Erfahrungswerten.

Lothar Horn
Geschäftsführer
Hartmetall-Werkzeugfabrik Paul Horn GmbH

New catalogues from HORN - benchmarks for productivity

Our tools provide you with fast, economical, high quality solutions, from single part to series production, for standard or special applications.

Our complete range of standard tools is summarised in the new catalogues

- Grooving
- Supermini & Mini Internal Machining
- Modular Holder Systems
- Ultra Hard Cutting Materials
- Milling Systems
- Drilling / Reaming
- Solid Carbide Mills
- Milling Catalogue Boehlerit
- Turning Catalogue Boehlerit

In each catalogue, the breakdown into the type of cutting process makes it easier for you to quickly find the products described. When choosing the individual cutting parameters, you will find numerous tables with proven empirical values.

Lothar Horn, CEO
Hartmetall-Werkzeugfabrik Paul Horn GmbH

A System DP

Vollhartmetall-Schaftfräser für alle gängigen Stahlwerkstoffe
Solid Carbide End Mills for all common steel materials

B System DS

Vollhartmetall-Schaftfräser für:

- hochfeste Stähle
- Titan
- Kobalt-Chrom-Legierungen
- Aluminium

Solid Carbide End Mills for:

- high tensile steels
- Titanium
- Cobalt Chromium Steels
- Aluminium

C System DG

Frälerschäfte mit wechselbaren Schneidköpfen für:

- Bohrnutenfräsen
- Fasen und Anbohren
- Kopierfräsen
- Hochvorschubsfräsen
- Verzahnungsfräsen

Milling shanks with exchangeable cutter heads for:









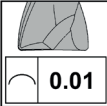





- Centre Cutting and Groove Milling
- Chamfering and Centering
- Copy Milling
- High Feed Milling
- Gear Milling

D Toodle Schnellaufspindeln

Toodle High Speed Spindle

	Werkstoff	Material			Härte / Hardness
P1.1	Kohlenstoffstahl	Carbon steel	0,2% C		140 HB
P1.2	Kohlenstoffstahl	Carbon steel	0,4% C		180 HB
P1.3	Kohlenstoffstahl	Carbon steel	0,6% C		200 HB
P2.1	Legierter Stahl	Alloyed steel	geglüht	annealed	180 HB
P2.2	Legierter Stahl	Alloyed steel	vergütet	quenched	280 HB
P2.3	Legierter Stahl	Alloyed steel	vergütet	quenched	350 HB
P3.1	hochlegierter Stahl	high alloyed steel	geglüht	annealed	200 HB
P3.2	hochlegierter Stahl	high alloyed steel	vergütet	quenched	325 HB
M1.1	Rostfreier Stahl	Stainless steel	martensitisch, ferritisch	martensitic, ferritic	200 HB
M2.1	Rostfreier Stahl	Stainless steel	austenitisch	austenitic	180 HB
M3.1	Rostfreier Stahl	Stainless steel	austenitisch, ferritisch	austenitic, ferritic	260 HB
K1.1	Grauguss	Grey cast iron	niedrige Festigkeit	low tensile strength	180 HB
K1.2	Grauguss	Grey cast iron	hohe Festigkeit	high tensile strength	250 HB
K2.1	Kugelgraphitguss	Spheroidal graphite cast iron	ferritisch	ferritic	160 HB
K2.2	Kugelgraphitguss	Spheroidal graphite cast iron	perlitisch	perlitic	250 HB
K3.1	Temperguss	Malleable cast iron	ferritisch	ferritic	125 HB
K3.2	Temperguss	Malleable cast iron	perlitisch	perlitic	225 HB
N1.1	Aluminium-Legierungen	Aluminum alloys	nicht vergütbar	not heat treatable	80 HB
N1.2	Aluminium-Legierungen	Aluminum alloys	vergütbar	heat treatable	120 HB
N2.1	Aluminiumguss	cast Aluminum	< 6% Si	< 6% Si	
N2.2	Aluminiumguss	cast Aluminum	6 - 10% Si	6 - 10% Si	
N2.3	Aluminiumguss	cast Aluminum	10 - 15% Si	10 - 15% Si	
N3.1	Kupfer-Legierungen	Copper alloys	nicht vergütbar	not heat treatable	90 HB
N3.2	Kupfer-Legierungen	Copper alloys	vergütbar	heat treatable	100 HB
N4.1	Kunststoffe	Synthetics			
S1.1	Titan-Legierungen	Titanium alloys			280 HB
S2.1	Nickel-Basis-Legierung	Nickel-base alloys			450 HB
S3.1	Cobalt-Basis-Legierung	Cobalt-base alloys			450 HB
H1.1	Gehärtete Stähle	hardened steels			50-55 HRC
H1.2	Gehärtete Stähle	hardened steels			56-59 HRC
H1.3	Gehärtete Stähle	hardened steels			60-63 HRC
H1.4	Gehärtete Stähle	hardened steels			> 63 HRC

	Zentrumsschneidend <i>Centre cutting</i>		Eintauchen horizontal <i>Diving horizontal</i>
	Zähnezahl <i>Number of teeth</i>		Eintauchen, Rampe, Helix, <i>Diving, ramping, helical,</i>
	Wuchtgüte <i>Balance quality</i>		Eintauchen, Rampe, Helix, vertikal <i>Diving, ramping, helical, vertical</i>
	Drallwinkel <i>Helix angle</i>		Formtoleranz <i>Form tolerance</i>
	Eckenradius <i>Corner radius</i>		Toleranz <i>Tolerance</i>
	Radius theoretisch <i>Radius theoretic</i>		Schaft DIN 6535 HA <i>Shank DIN 6535 HA</i>
	Eckfase <i>Corner chamfer</i>		Schaft DIN 6535 HB <i>Shank DIN 6535 HB</i>
	Vollradius <i>Full radius</i>		Rundlauf <i>Concentricity</i>
	scharfkantig <i>Sharp</i>		Innenkühlung <i>Internal cooling</i>
	Vollnut <i>Slot milling</i>		Trochoidalfräsen <i>Trochoidal milling</i>
	Eckfräsen <i>Corner milling</i>		Eintauchen <i>Diving</i>
	Kopierfräsen <i>Copy milling</i>		Effektive Nutzlänge <i>Effective neck length</i>

	DPSG.3	Schruppfräser Roughing End Mill	Ø 2,0 – Ø 20,0	Z 3	A4 – A5
	DPSG.4	Schruppfräser Roughing End Mill	Ø 2,0 – Ø 20,0	Z 4	A6 – A7
	DPSV	HPC - Schaftfräser HPC – End Mill	Ø 4,0 – Ø 20,0	Z 4	A8 – A9
	DPX	HPC - Schaftfräser HPC – End Mill	Ø 3,0 – Ø 16,0	Z 4	A10 – A13
	DPSB	Schruppfräser, Spanbrecher Roughing End Mill, chip breaker	Ø 4,0 – Ø 20,0	Z 4	A14 – A15
	DPS	Kordelschruppfräser Roughing End Mill with ripper profile	Ø 4,0 – Ø 20,0	Z 3-6	A16 – A17
	DPT	Schaftfräser, scharfkantig End Mill, sharp	Ø 1,0 – Ø 16,0	Z 4	A18 – A19
	DPTR.2	Torusfräser Torus End Mill	Ø 3,0 – Ø 20,0	Z 2	A20 – A21
	DPTR.4	Torusfräser Torus End Mill	Ø 3,0 – Ø 20,0	Z 4	A22 – A23
	DPM	Schaftfräser Mehrschneider End Mill multiple fluted	Ø 6,0 – Ø 20,0	Z 6-8	A24 – A25
	DPK.2	Schaftfräser Vollradius Ball Nose End Mill	Ø 1,0 – Ø 16,0	Z 2	A26 – A27
	DPK.3	Schaftfräser Vollradius Ball Nose End Mill	Ø 1,5 – Ø 20,0	Z 3	A28 – A29
	DPK.4	Schaftfräser Vollradius Ball Nose End Mill	Ø 1,0 – Ø 20,0	Z 4	A30 – A31
	DPFF	Fasfräser 60°, 90°, 120° Chamfering End Mill 60°, 90°, 120°	Ø 4,0 – Ø 12,0	Z 4	A32 – A33



Vollhartmetall-Schaftfräser

abgestimmt für:

- alle gängigen Stahlwerkstoffe

Solid Carbide End Mills

designed for:

- all common steel materials

DPSG

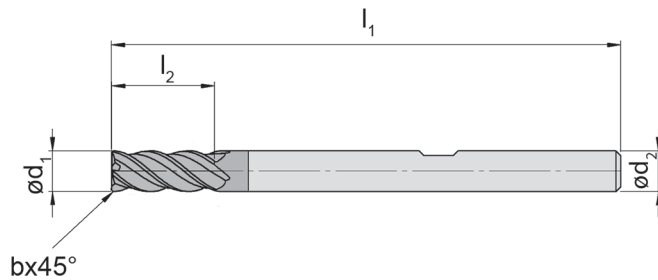
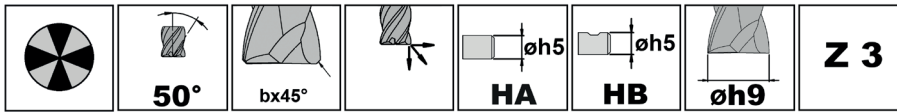

Bestellnummer Part number	d ₁	b	l ₂	d ₂	l ₁	Z	Ausführung Version	TF2K
DPSG.3.02.010.03.08	2	0,10	8	3	40	3	HA	▲
DPSG.3.03.010.03.10	3	0,10	10	3	40	3	HA	▲
DPSG.3.04.010.04.12	4	0,10	12	4	50	3	HA	▲
DPSG.3.05.015.05.15	5	0,15	15	5	50	3	HA	▲
DPSG.3.06.015.06.15	6	0,15	15	6	65	3	HB	▲
DPSG.3.08.020.08.20	8	0,20	20	8	65	3	HB	▲
DPSG.3.10.020.10.22	10	0,20	22	10	70	3	HB	▲
DPSG.3.12.025.12.25	12	0,25	25	12	80	3	HB	▲
DPSG.3.16.025.16.35	16	0,25	35	16	90	3	HB	▲
DPSG.3.20.025.20.40	20	0,25	40	20	102	3	HB	▲

▲ ab Lager / on stock Δ 4 Wochen / 4 weeks x auf Anfrage / upon request

● empfohlen / recommended

o bedingt einsetzbar / alternative recommendation

- nicht geeignet / not suitable

■ unbeschichtete HM-Sorten / uncoated grades

■ beschichtete HM-Sorten / coated grades

■ bestückt/Cermet / brazed/Cermet

Abmessungen in mm

Dimensions in mm

P	●
M	○
K	○
N	○
S	○
H	-

HM-Sorten
Carbide grades



Schnittdaten DPSG Ø 2,0 - 20,0 mm

Cutting Data DPSG Ø 2,0 - 20,0 mm

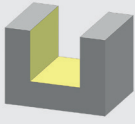
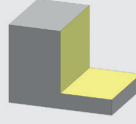

A

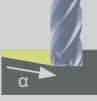
	 $v_c = \text{m/min}$	 $v_c = \text{m/min}$
P1.1	130	160
P1.2	120	140
P1.3	120	140
P2.1	110	130
P2.2	110	130
P2.3	110	130
P3.1	100	120
P3.2	100	120

d_1							
		f_z	a_e	a_p	f_z	a_e	a_p
2	5°	0,007	2	2	0,011	0,50	4,00
3	5°	0,011	3	3	0,017	0,75	6,00
4	5°	0,015	4	4	0,024	1,00	8,00
5	5°	0,019	5	5	0,030	1,25	10,00
6	5°	0,023	6	6	0,037	1,50	12,00
8	5°	0,031	8	8	0,050	2,00	16,00
10	5°	0,039	10	10	0,062	2,50	20,00
12	5°	0,047	12	12	0,075	3,00	24,00
16	5°	0,063	16	16	0,101	4,00	32,00
20	5°	0,079	20	20	0,127	5,00	40,00

Abmessungen in mm
Dimensions in mm

DPSG

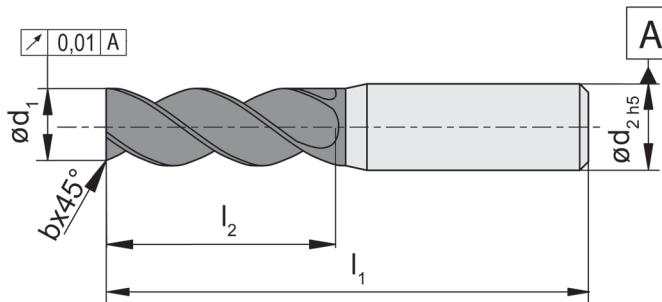
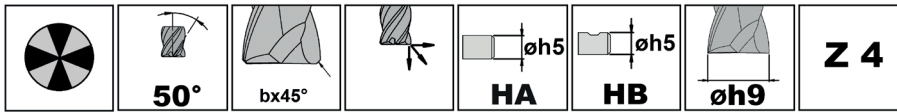

Bestellnummer Part number	d ₁	b	l ₂	d ₂	l ₁	Z	Ausführung Version	TF2K
DPSG.4.03.010.03.10	3	0,10	10	3	40	4	HA	▲
DPSG.4.04.010.04.12	4	0,10	12	4	50	4	HA	▲
DPSG.4.05.015.05.15	5	0,15	15	5	50	4	HA	▲
DPSG.4.06.015.06.15	6	0,15	15	6	65	4	HB	▲
DPSG.4.08.020.08.20	8	0,20	20	8	65	4	HB	▲
DPSG.4.10.020.10.22	10	0,20	22	10	70	4	HB	▲
DPSG.4.12.025.12.25	12	0,25	25	12	80	4	HB	▲
DPSG.4.16.025.16.35	16	0,25	35	16	90	4	HB	▲
DPSG.4.20.025.20.40	20	0,25	42	20	102	4	HB	▲

▲ ab Lager / on stock Δ 4 Wochen / 4 weeks x auf Anfrage / upon request

● empfohlen / recommended

o bedingt einsetzbar / alternative recommendation

- nicht geeignet / not suitable

■ unbeschichtete HM-Sorten / uncoated grades

■ beschichtete HM-Sorten / coated grades

■ bestückt/Cermet / brazed/Cermet

Abmessungen in mm

Dimensions in mm

P	●
M	○
K	○
N	○
S	○
H	-

HM-Sorten
Carbide grades



Schnittdaten DPSG Ø 3,0 - 20,0 mm

Cutting Data DPSG Ø 3,0 - 20,0 mm

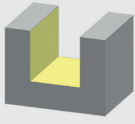
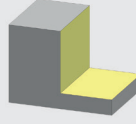

A

	 $v_c = \text{m/min}$	 $v_c = \text{m/min}$
P1.1	130	160
P1.2	120	140
P1.3	120	140
P2.1	110	130
P2.2	110	130
P2.3	110	130
P3.1	100	120
P3.2	100	120

d_1							
		f_z	a_e	a_p	f_z	a_e	a_p
3	4°	0,007	3	3	0,010	0,75	4,00
4	4°	0,011	4	4	0,017	1,00	6,00
5	4°	0,015	5	5	0,023	1,25	8,00
6	4°	0,019	6	6	0,030	1,50	10,00
8	4°	0,027	8	8	0,043	2,00	12,00
10	4°	0,035	10	10	0,055	2,50	16,00
12	4°	0,043	12	12	0,068	3,00	20,00
16	4°	0,059	16	16	0,094	4,00	24,00
20	4°	0,075	20	20	0,120	5,00	32,00
20	5°	0,079	20	20	0,127	5,00	40,00

Abmessungen in mm
Dimensions in mm

DPSV

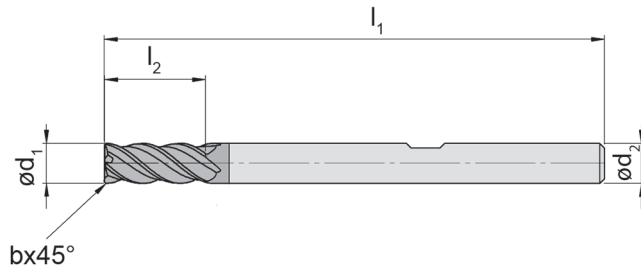
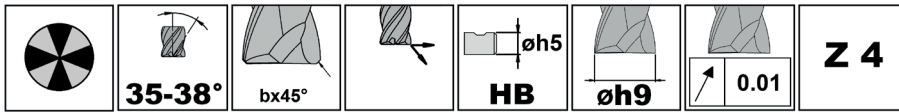

Bestellnummer Part number	d ₁	b	l ₂	d ₂	l ₁	Z	Ausführung Version	TF2K
DPSV.4.04.025.06.11	4	0,25	11	6	57	4	HB	▲
DPSV.4.05.025.06.13	5	0,25	13	6	57	4	HB	▲
DPSV.4.06.025.06.13	6	0,25	13	6	57	4	HB	▲
DPSV.4.08.025.08.19	8	0,25	19	8	63	4	HB	▲
DPSV.4.10.025.10.22	10	0,25	22	10	72	4	HB	▲
DPSV.4.12.025.12.26	12	0,25	26	12	83	4	HB	▲
DPSV.4.16.025.16.32	16	0,25	32	16	92	4	HB	▲
DPSV.4.20.040.20.38	20	0,40	38	20	104	4	HB	▲

▲ ab Lager / on stock Δ 4 Wochen / 4 weeks x auf Anfrage / upon request

● empfohlen / recommended

o bedingt einsetzbar / alternative recommendation

- nicht geeignet / not suitable

■ unbeschichtete HM-Sorten / uncoated grades

■ beschichtete HM-Sorten / coated grades

■ bestückt/Cermet / brazed/Cermet

Abmessungen in mm

Dimensions in mm

P	●
M	○
K	○
N	○
S	○
H	-

HM-Sorten
Carbide grades



Schnittdaten DPSV Ø 4,0 - 20,0 mm

Cutting Data DPSV Ø 4,0 - 20,0 mm

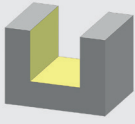
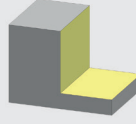

A

	 $v_c = \text{m/min}$	 $v_c = \text{m/min}$
P1.1	150	180
P1.2	140	170
P1.3	130	160
P2.1	120	140
P2.2	120	140
P2.3	110	130
P3.1	110	130
P3.2	110	130

d_1							
		f_z	a_e	a_p	f_z	a_e	a_p
4	4°	0,011	4	4	0,017	1,00	8,00
5	4°	0,015	5	5	0,023	1,25	10,00
6	4°	0,019	6	6	0,030	1,50	12,00
8	4°	0,027	8	8	0,043	2,00	16,00
10	4°	0,035	10	10	0,055	2,50	20,00
12	4°	0,043	12	12	0,068	3,00	24,00
16	4°	0,059	16	16	0,094	4,00	32,00
20	4°	0,075	20	20	0,120	5,00	40,00

Abmessungen in mm
Dimensions in mm

DPX

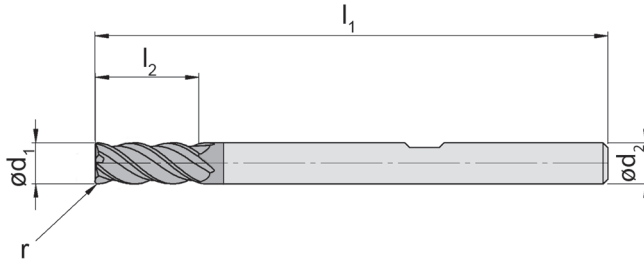
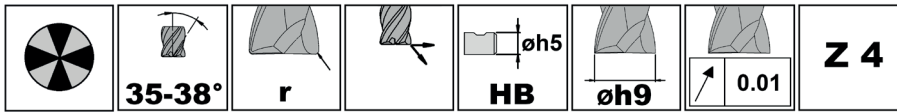

Bestellnummer Part number	d ₁	r	l ₂	d ₂	l ₁	Z	Ausführung Version	TF2K
DPX.4.03.025.06.11	3	0,25	11	6	57	4	HB	▲
DPX.4.03.050.06.13	3	0,50	13	6	57	4	HB	▲
DPX.4.04.050.06.13	4	0,50	13	6	57	4	HB	▲
DPX.4.05.050.06.13	5	0,50	13	6	57	4	HB	▲
DPX.4.06.050.06.13	6	0,50	13	6	57	4	HB	▲
DPX.4.06.100.06.13	6	1,00	13	6	57	4	HB	▲
DPX.4.06.150.06.13	6	1,50	13	6	57	4	HB	▲
DPX.4.08.050.08.19	8	0,50	19	8	63	4	HB	▲
DPX.4.08.100.08.19	8	1,00	19	8	63	4	HB	▲
DPX.4.08.150.08.19	8	1,50	19	8	63	4	HB	▲
DPX.4.10.050.10.22	10	0,50	22	10	72	4	HB	▲
DPX.4.10.100.10.22	10	1,00	22	10	72	4	HB	▲
DPX.4.10.150.10.22	10	1,50	22	10	72	4	HB	▲
DPX.4.12.050.12.26	12	0,50	26	12	83	4	HB	▲
DPX.4.12.150.12.26	12	1,50	26	12	83	4	HB	▲
DPX.4.16.150.16.32	16	1,50	32	16	92	4	HB	▲
DPX.4.16.300.16.32	16	3,00	32	16	92	4	HB	▲

▲ ab Lager / on stock Δ 4 Wochen / 4 weeks x auf Anfrage / upon request

● empfohlen / recommended

o bedingt einsetzbar / alternative recommendation

- nicht geeignet / not suitable

■ unbeschichtete HM-Sorten / uncoated grades

■ beschichtete HM-Sorten / coated grades

■ bestückt/Cermet / brazed/Cermet

Abmessungen in mm

Dimensions in mm

P	●
M	○
K	○
N	○
S	○
H	-

HM-Sorten
Carbide grades



Schnittdaten DPX Ø 3,0 - 16,0 mm

Cutting Data DPX Ø 3,0 - 16,0 mm

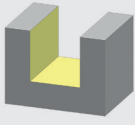
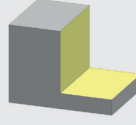

A

	 $v_c = \text{m/min}$	 $v_c = \text{m/min}$
P1.1	150	180
P1.2	140	170
P1.3	130	160
P2.1	120	140
P2.2	120	140
P2.3	110	130
P3.1	110	130
P3.2	110	130

d_1							
		f_z	a_e	a_p	f_z	a_e	a_p
3	3°	0,007	3	3	0,010	0,75	6,00
3	3°	0,007	3	3	0,010	0,75	6,00
4	4°	0,011	4	4	0,017	1,00	8,00
5	4°	0,015	5	5	0,023	1,25	10,00
6	4°	0,019	6	6	0,030	1,50	12,00
6	4°	0,019	6	6	0,030	1,50	12,00
6	4°	0,019	6	6	0,030	1,50	12,00
8	4°	0,027	8	8	0,043	2,00	16,00
8	4°	0,027	8	8	0,043	2,00	16,00
8	4°	0,027	8	8	0,043	2,00	16,00
10	4°	0,035	10	10	0,055	2,50	20,00
10	4°	0,035	10	10	0,055	2,50	20,00
10	4°	0,035	10	10	0,055	2,50	20,00
12	4°	0,043	12	12	0,068	3,00	24,00
12	4°	0,043	12	12	0,068	3,00	24,00
16	4°	0,059	16	16	0,094	4,00	32,00
16	4°	0,059	16	16	0,094	4,00	32,00

Abmessungen in mm
Dimensions in mm

DPX

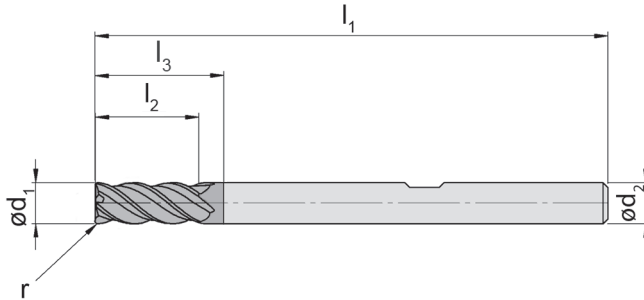
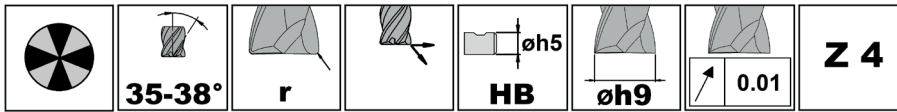

Bestellnummer Part number	d ₁	r	l ₂	l ₃	d ₂	l ₁	Z	Ausführung Type	TF2K
DPX.4.03.025.06.A21	3	0,25	11	21	6	57	4	HB	▲
DPX.4.03.050.06.A21	3	0,50	13	21	6	57	4	HB	▲
DPX.4.04.050.06.A21	4	0,50	13	21	6	57	4	HB	▲
DPX.4.05.050.06.A21	5	0,50	13	21	6	57	4	HB	▲
DPX.4.06.050.06.A21	6	0,50	13	21	6	57	4	HB	▲
DPX.4.06.100.06.A21	6	1,00	13	21	6	57	4	HB	▲
DPX.4.06.150.06.A21	6	1,50	13	21	6	57	4	HB	▲
DPX.4.08.050.08.A28	8	0,50	19	28	8	63	4	HB	▲
DPX.4.08.100.08.A28	8	1,00	19	28	8	63	4	HB	▲
DPX.4.08.150.08.A28	8	1,50	19	28	8	63	4	HB	▲
DPX.4.10.050.10.A32	10	0,50	22	32	10	72	4	HB	▲
DPX.4.10.100.10.A32	10	1,00	22	32	10	72	4	HB	▲
DPX.4.10.150.10.A32	10	1,50	22	32	10	72	4	HB	▲
DPX.4.12.050.12.A38	12	0,50	26	38	12	83	4	HB	▲
DPX.4.12.150.12.A38	12	1,50	26	38	12	83	4	HB	▲
DPX.4.16.150.16.A44	16	1,50	32	44	16	92	4	HB	▲
DPX.4.16.300.16.A44	16	3,00	32	44	16	92	4	HB	▲

▲ ab Lager / on stock Δ 4 Wochen / 4 weeks x auf Anfrage / upon request

● empfohlen / recommended

o bedingt einsetzbar / alternative recommendation

- nicht geeignet / not suitable

■ unbeschichtete HM-Sorten / uncoated grades

■ beschichtete HM-Sorten / coated grades

■ bestückt/Cermet / brazed/Cermet

Abmessungen in mm

Dimensions in mm

P	●
M	○
K	○
N	○
S	○
H	-

HM-Sorten
Carbide grades



Schnittdaten DPX Ø 3,0 - 16,0 mm

Cutting Data DPX Ø 3,0 - 16,0 mm

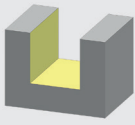
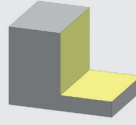

A

	 $v_c = \text{m/min}$	 $v_c = \text{m/min}$
P1.1	150	180
P1.2	140	170
P1.3	130	160
P2.1	120	140
P2.2	120	140
P2.3	110	130
P3.1	110	130
P3.2	110	130

d_1							
		f_z	a_e	a_p	f_z	a_e	a_p
3	3°	0,007	3	3	0,010	0,75	6,00
3	3°	0,007	3	3	0,010	0,75	6,00
4	4°	0,011	4	4	0,017	1,00	8,00
5	4°	0,015	5	5	0,023	1,25	10,00
6	4°	0,019	6	6	0,030	1,50	12,00
6	4°	0,019	6	6	0,030	1,50	12,00
6	4°	0,019	6	6	0,030	1,50	12,00
8	4°	0,027	8	8	0,043	2,00	16,00
8	4°	0,027	8	8	0,043	2,00	16,00
8	4°	0,027	8	8	0,043	2,00	16,00
10	4°	0,035	10	10	0,055	2,50	20,00
10	4°	0,035	10	10	0,055	2,50	20,00
10	4°	0,035	10	10	0,055	2,50	20,00
12	4°	0,043	12	12	0,068	3,00	24,00
12	4°	0,043	12	12	0,068	3,00	24,00
16	4°	0,059	16	16	0,094	4,00	32,00
16	4°	0,059	16	16	0,094	4,00	32,00

Abmessungen in mm
Dimensions in mm

Schruppfräser mit Spanbrecher

Roughing End Mill with chip breaker



DPSB

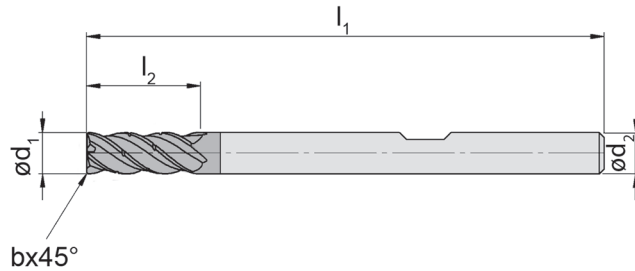
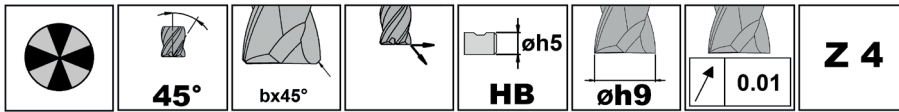

Bestellnummer Part number	d ₁	b	l ₂	d ₂	l ₁	Z	Ausführung Version	TF2K
DPSB.4.04.025.06.11	4	0,25	11	6	57	4	HB	▲
DPSB.4.06.025.06.13	6	0,25	13	6	57	4	HB	▲
DPSB.4.08.025.08.19	8	0,25	19	8	63	4	HB	▲
DPSB.4.10.025.10.22	10	0,25	22	10	72	4	HB	▲
DPSB.4.12.025.12.26	12	0,25	26	12	83	4	HB	▲
DPSB.4.16.025.16.32	16	0,25	32	16	92	4	HB	▲
DPSB.4.20.040.20.38	20	0,40	38	20	104	4	HB	▲

▲ ab Lager / on stock Δ 4 Wochen / 4 weeks x auf Anfrage / upon request

● empfohlen / recommended

○ bedingt einsetzbar / alternative recommendation

- nicht geeignet / not suitable

■ unbeschichtete HM-Sorten / uncoated grades

■ beschichtete HM-Sorten / coated grades

■ bestückt/Cermet / brazed/Cermet

Abmessungen in mm

Dimensions in mm

P	●
M	○
K	○
N	○
S	○
H	-

HM-Sorten
Carbide grades



Schnittdaten DPSB Ø 4,0 - 20,0 mm

Cutting Data DPSB Ø 4,0 - 20,0 mm

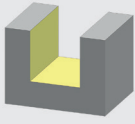
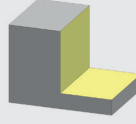

A

	 $v_c = \text{m/min}$	 $v_c = \text{m/min}$
P1.1	130	160
P1.2	120	140
P1.3	120	140
P2.1	110	130
P2.2	110	130
P2.3	110	130
P3.1	100	120
P3.2	100	120

d_1							
		f_z	a_e	a_p	f_z	a_e	a_p
4	4°	0,011	4	4	0,015	1,20	8,00
6	4°	0,019	6	6	0,027	1,80	12,00
8	4°	0,027	8	8	0,039	2,40	16,00
10	4°	0,035	10	10	0,051	3,00	20,00
12	4°	0,043	12	12	0,062	3,60	24,00
16	4°	0,059	16	16	0,086	4,80	32,00
20	4°	0,075	20	20	0,110	6,00	40,00

Abmessungen in mm
Dimensions in mm

Kordelschruppfräser

Roughing End Mill with ripper profile



DPS

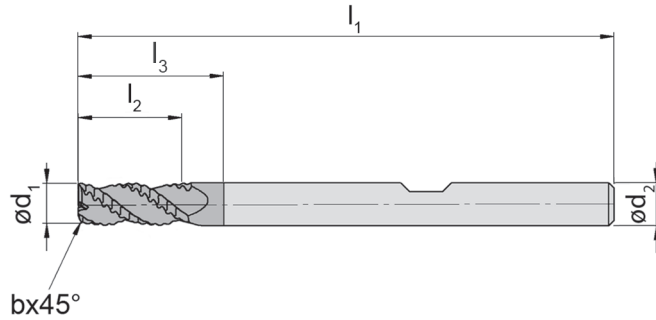
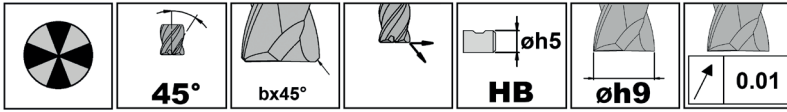

Bestellnummer Part number	d ₁	b	l ₂	l ₃	d ₂	l ₁	Z	Ausführung Version	TF2K
DPS.3.04.025.06.11	4	0,25	11	-	6	57	3	HB	▲
DPS.4.05.025.06.13	5	0,25	13	-	6	57	4	HB	▲
DPS.4.06.025.06.13	6	0,25	13	-	6	57	4	HB	▲
DPS.4.06.025.06.A21	6	0,25	13	21	6	57	4	HB	▲
DPS.4.08.025.08.19	8	0,25	19	-	8	63	4	HB	▲
DPS.4.08.025.08.A27	8	0,25	19	27	8	63	4	HB	▲
DPS.4.10.025.10.22	10	0,25	22	-	10	72	4	HB	▲
DPS.4.10.025.10.A32	10	0,25	22	32	10	72	4	HB	▲
DPS.4.12.025.12.26	12	0,25	26	-	12	83	4	HB	▲
DPS.4.12.025.12.A38	12	0,25	26	38	12	83	4	HB	▲
DPS.5.16.025.16.32	16	0,25	32	-	16	92	5	HB	▲
DPS.5.16.025.16.A44	16	0,25	32	44	16	92	5	HB	▲
DPS.6.20.040.20.38	20	0,40	38	-	20	104	6	HB	▲
DPS.6.20.040.20.A54	20	0,40	38	54	20	104	6	HB	▲

▲ ab Lager / on stock Δ 4 Wochen / 4 weeks x auf Anfrage / upon request

● empfohlen / recommended

o bedingt einsetzbar / alternative recommendation

- nicht geeignet / not suitable

■ unbeschichtete HM-Sorten / uncoated grades

■ beschichtete HM-Sorten / coated grades

■ bestückt/Cermet / brazed/Cermet

Abmessungen in mm

Dimensions in mm

P	●
M	○
K	○
N	○
S	○
H	-

HM-Sorten
Carbide grades



Schnittdaten DPS Ø 4,0 - 20,0 mm

Cutting Data DPS Ø 4,0 - 20,0 mm

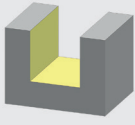
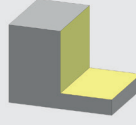

A

	 $v_c = \text{m/min}$	 $v_c = \text{m/min}$
P1.1	130	160
P1.2	120	140
P1.3	120	140
P2.1	110	130
P2.2	110	130
P2.3	110	130
P3.1	100	120
P3.2	100	120

d_1							
		f_z	a_e	a_p	f_z	a_e	a_p
4	4°	0,011	4	4	0,013	1,60	8,00
5	4°	0,015	5	5	0,018	2,00	10,00
6	4°	0,019	6	6	0,023	2,40	12,00
6	4°	0,019	6	6	0,023	2,40	12,00
8	4°	0,027	8	8	0,034	3,20	16,00
8	4°	0,027	8	8	0,034	3,20	16,00
10	4°	0,035	10	10	0,044	4,00	20,00
10	4°	0,035	10	10	0,044	4,00	20,00
12	4°	0,043	12	12	0,054	4,80	24,00
12	4°	0,043	12	12	0,054	4,80	24,00
16	3°	0,057	16	16	0,071	6,40	32,00
16	3°	0,057	16	16	0,071	6,40	32,00
20	3°	0,072	20	20	0,089	8,00	40,00
20	3°	0,072	20	20	0,089	8,00	40,00

Abmessungen in mm
Dimensions in mm

DPT

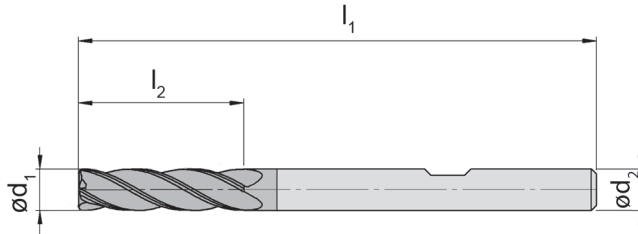
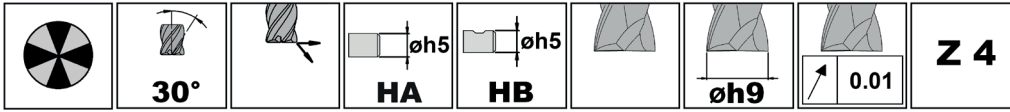

Bestellnummer Part number	d ₁	l ₂	d ₂	l ₁	Z	Ausführung Version	TF2K
DPT.4.01.00.03.03	1,0	3	3	40	4	HA	▲
DPT.4.15.00.03.05	1,5	5	3	40	4	HA	▲
DPT.4.02.00.03.07	2,0	7	3	40	4	HA	▲
DPT.4.25.00.03.07	2,5	7	3	40	4	HA	▲
DPT.4.03.00.03.10	3,0	10	3	40	4	HA	▲
DPT.4.35.00.04.12	3,5	12	4	50	4	HA	▲
DPT.4.04.00.04.15	4,0	15	4	50	4	HA	▲
DPT.4.45.00.05.15	4,5	15	5	50	4	HA	▲
DPT.4.05.00.05.15	5,0	15	5	50	4	HA	▲
DPT.4.07.00.08.20	7,0	20	8	65	4	HB	▲
DPT.4.09.00.10.22	9,0	22	10	70	4	HB	▲
DPT.4.11.00.11.25	11,0	25	11	70	4	HA	▲
DPT.4.06.00.06.20	6,0	20	6	65	4	HB	▲
DPT.4.08.00.08.20	8,0	20	8	65	4	HB	▲
DPT.4.10.00.10.22	10,0	22	10	70	4	HB	▲
DPT.4.12.00.12.25	12,0	25	12	80	4	HB	▲
DPT.4.14.00.14.30	14,0	30	14	90	4	HA	▲
DPT.4.16.00.16.32	16,0	32	16	90	4	HB	▲

▲ ab Lager / on stock Δ 4 Wochen / 4 weeks x auf Anfrage / upon request

● empfohlen / recommended

o bedingt einsetzbar / alternative recommendation

- nicht geeignet / not suitable

■ unbeschichtete HM-Sorten / uncoated grades

■ beschichtete HM-Sorten / coated grades

■ bestückt/Cermet / brazed/Cermet

Abmessungen in mm

Dimensions in mm

P	●
M	○
K	○
N	○
S	○
H	-

HM-Sorten
Carbide grades



Schnittdaten DPT Ø 1,0 - 16,0 mm

Cutting Data DPT Ø 1,0 - 16,0 mm

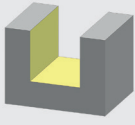
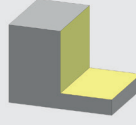

A

	 $v_c = \text{m/min}$	 $v_c = \text{m/min}$
P1.1	130	160
P1.2	120	140
P1.3	120	140
P2.1	110	130
P2.2	110	130
P2.3	110	130
P3.1	100	120
P3.2	100	120

d_1							
		f_z	a_e	a_p	f_z	a_e	a_p
1,0	4°	0,006	1	1	0,010	0,25	2,00
1,5	4°	0,007	2	2	0,013	0,38	3,00
2,0	4°	0,009	2	2	0,016	0,50	4,00
2,5	4°	0,011	3	3	0,019	0,63	5,00
3,0	4°	0,012	3	3	0,022	0,75	6,00
3,5	4°	0,014	4	4	0,024	0,88	7,00
4,0	4°	0,016	4	4	0,027	1,00	8,00
4,5	4°	0,017	5	5	0,030	1,13	9,00
5,0	4°	0,019	5	5	0,033	1,25	10,00
7,0	4°	0,022	6	6	0,038	1,50	12,00
9,0	4°	0,026	7	7	0,044	1,75	14,00
11,0	4°	0,029	8	8	0,049	2,00	16,00
6,0	4°	0,036	10	10	0,060	2,50	20,00
8,0	4°	0,042	12	12	0,072	3,00	24,00
10,0	4°	0,049	14	14	0,083	3,50	28,00
12,0	4°	0,056	16	16	0,094	4,00	32,00
14,0	4°	0,062	18	18	0,105	4,50	36,00
16,0	4°	0,069	20	20	0,116	5,00	40,00

Abmessungen in mm
Dimensions in mm

DPTR

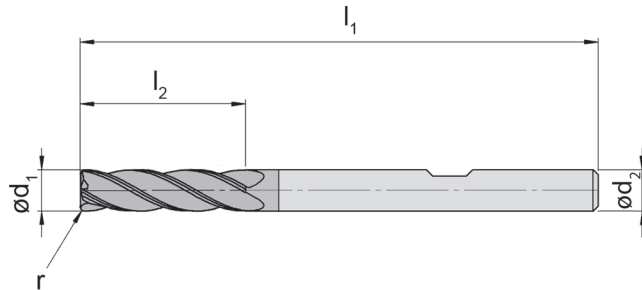
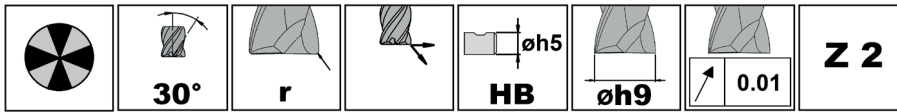

Bestellnummer Part number	d ₁	r	l ₂	d ₂	l ₁	Z	Ausführung Version	TF2K
DPTR.2.03.03.06.12	3	0,3	12	6	50	2	HB	▲
DPTR.2.04.03.06.15	4	0,3	15	6	50	2	HB	▲
DPTR.2.04.05.06.15	4	0,5	15	6	50	2	HB	▲
DPTR.2.05.03.06.20	5	0,3	20	6	60	2	HB	▲
DPTR.2.05.05.06.20	5	0,5	20	6	60	2	HB	▲
DPTR.2.06.03.06.20	6	0,3	20	6	60	2	HB	▲
DPTR.2.06.05.06.20	6	0,5	20	6	60	2	HB	▲
DPTR.2.06.10.06.20	6	1,0	20	6	60	2	HB	▲
DPTR.2.08.03.08.25	8	0,3	25	8	70	2	HB	▲
DPTR.2.08.05.08.25	8	0,5	25	8	70	2	HB	▲
DPTR.2.08.10.08.25	8	1,0	25	8	70	2	HB	▲
DPTR.2.08.15.08.25	8	1,5	25	8	70	2	HB	▲
DPTR.2.08.20.08.25	8	2,0	25	8	70	2	HB	▲
DPTR.2.10.03.10.30	10	0,3	30	10	90	2	HB	▲
DPTR.2.10.05.10.30	10	0,5	30	10	90	2	HB	▲
DPTR.2.10.10.10.30	10	1,0	30	10	90	2	HB	▲
DPTR.2.10.15.10.30	10	1,5	30	10	90	2	HB	▲
DPTR.2.10.20.10.30	10	2,0	30	10	90	2	HB	▲
DPTR.2.12.05.12.30	12	0,5	30	12	90	2	HB	▲
DPTR.2.12.10.12.30	12	1,0	30	12	90	2	HB	▲
DPTR.2.12.15.12.30	12	1,5	30	12	90	2	HB	▲
DPTR.2.12.20.12.30	12	2,0	30	12	90	2	HB	▲
DPTR.2.16.05.16.50	16	0,5	50	16	110	2	HB	▲
DPTR.2.16.10.16.50	16	1,0	50	16	110	2	HB	▲
DPTR.2.16.15.16.50	16	1,5	50	16	110	2	HB	▲
DPTR.2.16.20.16.50	16	2,0	50	16	110	2	HB	▲
DPTR.2.20.05.20.50	20	0,5	50	20	110	2	HB	▲
DPTR.2.20.10.20.50	20	1,0	50	20	110	2	HB	▲
DPTR.2.20.15.20.50	20	1,5	50	20	110	2	HB	▲
DPTR.2.20.20.20.50	20	2,0	50	20	110	2	HB	▲

▲ ab Lager / on stock Δ 4 Wochen / 4 weeks x auf Anfrage / upon request

● empfohlen / recommended

○ bedingt einsetzbar / alternative recommendation

- nicht geeignet / not suitable

■ unbeschichtete HM-Sorten / uncoated grades

■ beschichtete HM-Sorten / coated grades

■ bestückt/Cermet / brazed/Cermet

Abmessungen in mm

Dimensions in mm

P	●
M	○
K	○
N	○
S	○
H	-

HM-Sorten
Carbide grades



Schnittdaten DPTR Ø 3,0 - 20,0 mm

Cutting Data DPTR Ø 3,0 - 20,0 mm

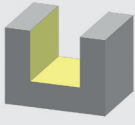
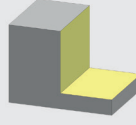

A

	 $v_c = \text{m/min}$	 $v_c = \text{m/min}$
P1.1	130	160
P1.2	120	140
P1.3	120	140
P2.1	110	130
P2.2	110	130
P2.3	110	130
P3.1	100	120
P3.2	100	120

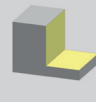
d_1							
		f_z	a_e	a_p	f_z	a_e	a_p
3	5°	0,019	3	3	0,036	0,75	6,00
4	5°	0,023	4	4	0,041	1,00	8,00
4	5°	0,023	4	4	0,041	1,00	8,00
5	5°	0,026	5	5	0,047	1,25	10,00
5	5°	0,026	5	5	0,047	1,25	10,00
6	5°	0,029	6	6	0,052	1,50	12,00
6	5°	0,029	6	6	0,052	1,50	12,00
6	5°	0,029	6	6	0,052	1,50	12,00
8	5°	0,036	8	8	0,063	2,00	16,00
8	5°	0,036	8	8	0,063	2,00	16,00
8	5°	0,036	8	8	0,063	2,00	16,00
8	5°	0,036	8	8	0,063	2,00	16,00
8	5°	0,036	8	8	0,063	2,00	16,00
10	5°	0,043	10	10	0,074	2,50	20,00
10	5°	0,043	10	10	0,074	2,50	20,00
10	5°	0,043	10	10	0,074	2,50	20,00
10	5°	0,043	10	10	0,074	2,50	20,00
10	5°	0,043	10	10	0,074	2,50	20,00
12	5°	0,049	12	12	0,086	3,00	24,00
12	5°	0,049	12	12	0,086	3,00	24,00
12	5°	0,049	12	12	0,086	3,00	24,00
12	5°	0,049	12	12	0,086	3,00	24,00
16	5°	0,063	16	16	0,108	4,00	32,00
16	5°	0,063	16	16	0,108	4,00	32,00
16	5°	0,063	16	16	0,108	4,00	32,00
16	5°	0,063	16	16	0,108	4,00	32,00
20	5°	0,076	20	20	0,130	5,00	40,00
20	5°	0,076	20	20	0,130	5,00	40,00
20	5°	0,076	20	20	0,130	5,00	40,00
20	5°	0,076	20	20	0,130	5,00	40,00

Abmessungen in mm
Dimensions in mm

DPTR

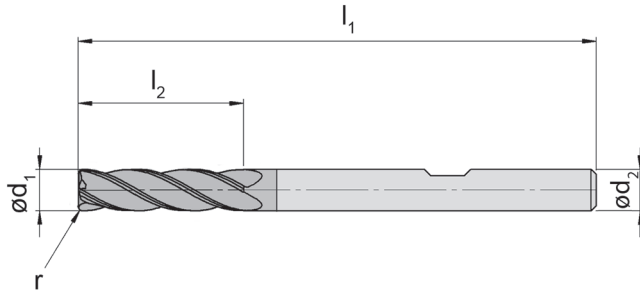
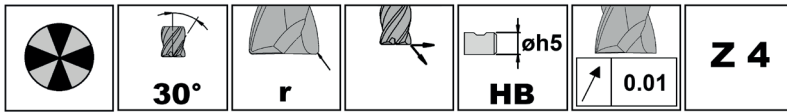

Bestellnummer Part number	d ₁	r	l ₂	d ₂	l ₁	Z	Ausführung Version	TF2K
DPTR.4.03.03.06.12	3	0,3	12	6	50	4	HB	▲
DPTR.4.04.03.06.15	4	0,3	15	6	50	4	HB	▲
DPTR.4.04.05.06.15	4	0,5	15	6	50	4	HB	▲
DPTR.4.05.03.06.20	5	0,3	20	6	60	4	HB	▲
DPTR.4.05.05.06.20	5	0,5	20	6	60	4	HB	▲
DPTR.4.06.03.06.20	6	0,3	20	6	60	4	HB	▲
DPTR.4.06.05.06.20	6	0,5	20	6	60	4	HB	▲
DPTR.4.06.10.06.20	6	1,0	20	6	60	4	HB	▲
DPTR.4.08.03.08.25	8	0,3	25	8	70	4	HB	▲
DPTR.4.08.05.08.25	8	0,5	25	8	70	4	HB	▲
DPTR.4.08.10.08.25	8	1,0	25	8	70	4	HB	▲
DPTR.4.08.15.08.25	8	1,5	25	8	70	4	HB	▲
DPTR.4.08.20.08.25	8	2,0	25	8	70	4	HB	▲
DPTR.4.10.03.10.30	10	0,3	30	10	90	4	HB	▲
DPTR.4.10.05.10.30	10	0,5	30	10	90	4	HB	▲
DPTR.4.10.10.10.30	10	1,0	30	10	90	4	HB	▲
DPTR.4.10.15.10.30	10	1,5	30	10	90	4	HB	▲
DPTR.4.10.20.10.30	10	2,0	30	10	90	4	HB	▲
DPTR.4.12.05.12.30	12	0,5	30	12	90	4	HB	▲
DPTR.4.12.10.12.30	12	1,0	30	12	90	4	HB	▲
DPTR.4.12.15.12.30	12	1,5	30	12	90	4	HB	▲
DPTR.4.12.20.12.30	12	2,0	30	12	90	4	HB	▲
DPTR.4.16.05.16.50	16	0,5	50	16	110	4	HB	▲
DPTR.4.16.10.16.50	16	1,0	50	16	110	4	HB	▲
DPTR.4.16.15.16.50	16	1,5	50	16	110	4	HB	▲
DPTR.4.16.20.16.50	16	2,0	50	16	110	4	HB	▲
DPTR.4.20.05.20.50	20	0,5	50	20	110	4	HB	▲
DPTR.4.20.10.20.50	20	1,0	50	20	110	4	HB	▲
DPTR.4.20.15.20.50	20	1,5	50	20	110	4	HB	▲
DPTR.4.20.20.20.50	20	2,0	50	20	110	4	HB	▲

▲ ab Lager / on stock Δ 4 Wochen / 4 weeks x auf Anfrage / upon request

● empfohlen / recommended

○ bedingt einsetzbar / alternative recommendation

- nicht geeignet / not suitable

■ unbeschichtete HM-Sorten / uncoated grades

■ beschichtete HM-Sorten / coated grades

■ bestückt/Cermet / brazed/Cermet

Abmessungen in mm

Dimensions in mm

P	●
M	○
K	○
N	○
S	○
H	-

HM-Sorten
Carbide grades



Schnittdaten DPTR Ø 3,0 - 20,0 mm

Cutting Data DPTR Ø 3,0 - 20,0 mm

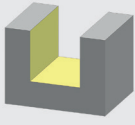
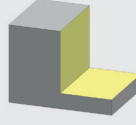

A

	 $v_c = \text{m/min}$	 $v_c = \text{m/min}$
P1.1	130	160
P1.2	120	140
P1.3	120	140
P2.1	110	130
P2.2	110	130
P2.3	110	130
P3.1	100	120
P3.2	100	120

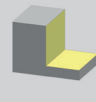
d_1							
		f_z	a_e	a_p	f_z	a_e	a_p
3	4°	0,012	3	3	0,022	0,75	6,00
4	4°	0,016	4	4	0,027	1,00	8,00
4	4°	0,016	4	4	0,027	1,00	8,00
5	4°	0,019	5	5	0,033	1,25	10,00
5	4°	0,019	5	5	0,033	1,25	10,00
6	4°	0,022	6	6	0,038	1,50	12,00
6	4°	0,022	6	6	0,038	1,50	12,00
6	4°	0,022	6	6	0,038	1,50	12,00
8	4°	0,029	8	8	0,049	2,00	16,00
8	4°	0,029	8	8	0,049	2,00	16,00
8	4°	0,029	8	8	0,049	2,00	16,00
8	4°	0,029	8	8	0,049	2,00	16,00
8	4°	0,029	8	8	0,049	2,00	16,00
10	4°	0,036	10	10	0,060	2,50	20,00
10	4°	0,036	10	10	0,060	2,50	20,00
10	4°	0,036	10	10	0,060	2,50	20,00
10	4°	0,036	10	10	0,060	2,50	20,00
10	4°	0,036	10	10	0,060	2,50	20,00
12	4°	0,042	12	12	0,072	3,00	24,00
12	4°	0,042	12	12	0,072	3,00	24,00
12	4°	0,042	12	12	0,072	3,00	24,00
12	4°	0,042	12	12	0,072	3,00	24,00
16	4°	0,056	16	16	0,094	4,00	32,00
16	4°	0,056	16	16	0,094	4,00	32,00
16	4°	0,056	16	16	0,094	4,00	32,00
16	4°	0,056	16	16	0,094	4,00	32,00
20	4°	0,069	20	20	0,116	5,00	40,00
20	4°	0,069	20	20	0,116	5,00	40,00
20	4°	0,069	20	20	0,116	5,00	40,00
20	4°	0,069	20	20	0,116	5,00	40,00

Abmessungen in mm
Dimensions in mm

A Schafffräser Mehrschneider

End Mill multiple fluted



DPM

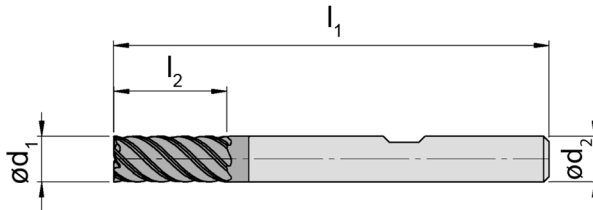
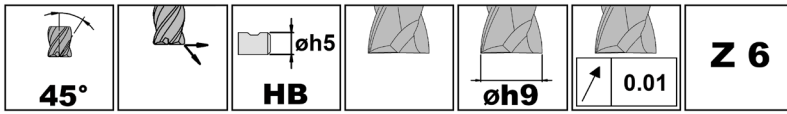

Bestellnummer Part number	d ₁	l ₂	d ₂	l ₁	Z	Ausführung Version	TF2K
DPM.6.06.00.06.13	6	13	6	58	6	HB	▲
DPM.6.08.00.08.19	8	19	8	65	6	HB	▲
DPM.6.10.00.10.22	10	22	10	72	6	HB	▲
DPM.6.12.00.12.26	12	26	12	83	6	HB	▲
DPM.6.16.00.16.32	16	32	16	92	6	HB	▲
DPM.8.20.00.20.38	20	38	20	103	8	HB	▲

▲ ab Lager / on stock Δ 4 Wochen / 4 weeks x auf Anfrage / upon request

● empfohlen / recommended

o bedingt einsetzbar / alternative recommendation

- nicht geeignet / not suitable

□ unbeschichtete HM-Sorten / uncoated grades

■ beschichtete HM-Sorten / coated grades

■ bestückt/Cermet / brazed/Cermet

Abmessungen in mm

Dimensions in mm

P	●
M	○
K	○
N	○
S	○
H	-

HM-Sorten
Carbide grades



Schnittdaten DPM Ø 6,0 - 20,0 mm

Cutting Data DPM Ø 6,0 - 20,0 mm

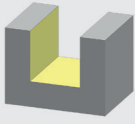
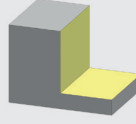

A

	 $v_c = \text{m/min}$	 $v_c = \text{m/min}$
P1.1	130	160
P1.2	120	140
P1.3	120	140
P2.1	110	130
P2.2	110	130
P2.3	110	130
P3.1	100	120
P3.2	100	120

d_1							
		f_z	a_e	a_p	f_z	a_e	a_p
6	3°	0,010	0,60	12,00	0,018	0,06	12,00
8	3°	0,015	0,80	16,00	0,035	0,08	16,00
10	3°	0,021	1,00	20,00	0,053	0,10	20,00
12	3°	0,027	1,20	24,00	0,070	0,12	24,00
16	3°	0,038	1,60	32,00	0,104	0,16	32,00
20	3°	0,040	2,00	40,00	0,110	0,20	40,00

Abmessungen in mm
Dimensions in mm

DPK

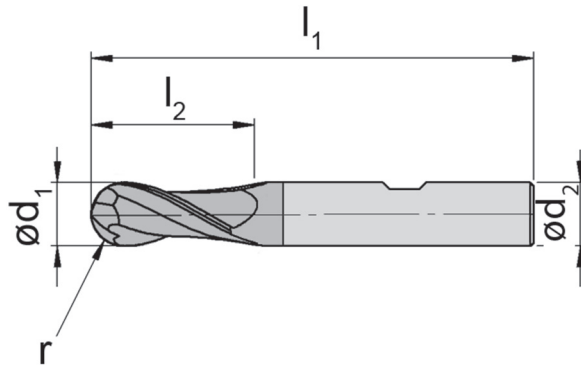
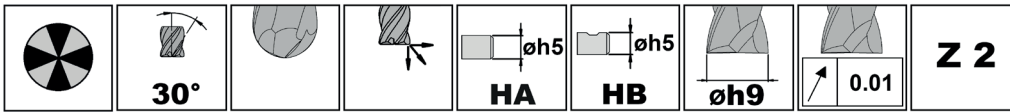

Bestellnummer Part number	d ₁	r	l ₂	d ₂	l ₁	Z	Ausführung Type	TF2K
DPK.2.010.03.03	1,0	0,50	3	3	40	2	HA	▲
DPK.2.015.03.05	1,5	0,75	5	3	40	2	HA	▲
DPK.2.020.03.07	2,0	1,00	7	3	40	2	HA	▲
DPK.2.025.03.07	2,5	1,25	7	3	40	2	HA	▲
DPK.2.030.03.10	3,0	1,50	10	3	40	2	HA	▲
DPK.2.035.04.12	3,5	1,75	12	4	50	2	HA	▲
DPK.2.040.04.15	4,0	2,00	15	4	50	2	HA	▲
DPK.2.045.05.15	4,5	2,25	15	5	50	2	HA	▲
DPK.2.050.05.15	5,0	2,50	15	5	50	2	HA	▲
DPK.2.060.06.20	6,0	3,00	20	6	65	2	HB	▲
DPK.2.080.08.20	8,0	4,00	20	8	65	2	HB	▲
DPK.2.100.10.22	10,0	5,00	22	10	70	2	HB	▲
DPK.2.120.12.25	12,0	6,00	25	12	80	2	HB	▲
DPK.2.160.16.32	16,0	8,00	32	16	90	2	HB	▲

▲ ab Lager / on stock Δ 4 Wochen / 4 weeks x auf Anfrage / upon request

● empfohlen / recommended

o bedingt einsetzbar / alternative recommendation

- nicht geeignet / not suitable

■ unbeschichtete HM-Sorten / uncoated grades

■ beschichtete HM-Sorten / coated grades

■ bestückt/Cermet / brazed/Cermet

Abmessungen in mm

Dimensions in mm

P	●
M	○
K	○
N	○
S	○
H	-

HM-Sorten
Carbide grades



Schnittdaten DPK Ø 1,0 - 16,0 mm

Cutting Data DPK Ø 1,0 - 16,0 mm

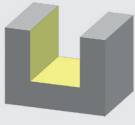
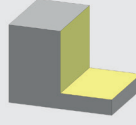

A

	 $v_c = \text{m/min}$	 $v_c = \text{m/min}$
P1.1	130	160
P1.2	120	140
P1.3	120	140
P2.1	110	130
P2.2	110	130
P2.3	110	130
P3.1	100	120
P3.2	100	120

d_1							
		f_z	a_e	a_p	f_z	a_e	a_p
1,0	5°	0,016	0,30	0,30	0,023	0,02	0,05
1,5	5°	0,019	0,45	0,45	0,027	0,02	0,08
2,0	5°	0,022	0,60	0,60	0,031	0,03	0,10
2,5	5°	0,025	0,75	0,75	0,034	0,04	0,13
3,0	5°	0,028	0,90	0,90	0,038	0,05	0,15
3,5	5°	0,031	1,05	1,05	0,042	0,05	0,18
4,0	5°	0,034	1,20	1,20	0,045	0,06	0,20
4,5	5°	0,037	1,35	1,35	0,049	0,07	0,23
5,0	5°	0,040	1,50	1,50	0,053	0,08	0,25
6,0	5°	0,046	1,80	1,80	0,060	0,09	0,30
8,0	5°	0,058	2,40	2,40	0,075	0,12	0,40
10,0	5°	0,070	3,00	3,00	0,090	0,15	0,50
12,0	5°	0,081	3,60	3,60	0,105	0,18	0,60
16,0	5°	0,105	4,80	4,80	0,134	0,24	0,80

Abmessungen in mm
Dimensions in mm

DPK

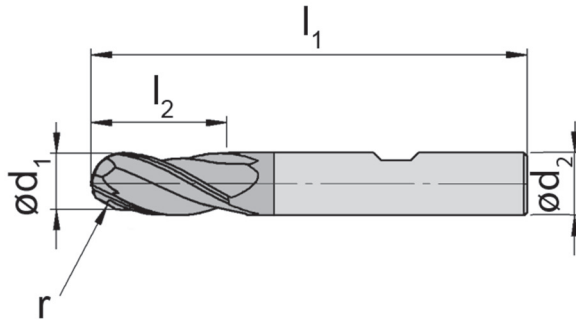
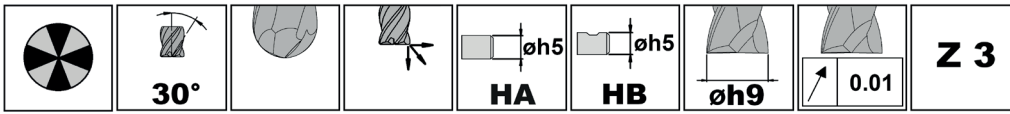

Bestellnummer Part number	d ₁	r	l ₂	d ₂	l ₁	Z	Ausführung Type	TF2K
DPK.3.015.03.05	1,5	0,75	5	3	40	3	HA	▲
DPK.3.020.03.07	2,0	1,00	7	3	40	3	HA	▲
DPK.3.025.03.07	2,5	1,25	7	3	40	3	HA	▲
DPK.3.030.03.10	3,0	1,50	10	3	40	3	HA	▲
DPK.3.035.04.12	3,5	1,75	12	4	50	3	HA	▲
DPK.3.040.04.15	4,0	2,00	15	4	50	3	HA	▲
DPK.3.045.05.15	4,5	2,25	15	5	50	3	HA	▲
DPK.3.050.05.15	5,0	2,50	15	5	50	3	HA	▲
DPK.3.060.06.20	6,0	3,00	20	6	65	3	HB	▲
DPK.3.080.08.20	8,0	4,00	20	8	65	3	HB	▲
DPK.3.100.10.22	10,0	5,00	22	10	70	3	HB	▲
DPK.3.120.12.25	12,0	6,00	25	12	80	3	HB	▲
DPK.3.140.14.30	14,0	7,00	30	14	90	3	HA	▲
DPK.3.160.16.32	16,0	8,00	32	16	90	3	HB	▲
DPK.3.200.20.38	20,0	10,00	38	20	100	3	HB	▲

▲ ab Lager / on stock Δ 4 Wochen / 4 weeks x auf Anfrage / upon request

● empfohlen / recommended

o bedingt einsetzbar / alternative recommendation

- nicht geeignet / not suitable

■ unbeschichtete HM-Sorten / uncoated grades

■ beschichtete HM-Sorten / coated grades

■ bestückt/Cermet / brazed/Cermet

Abmessungen in mm

Dimensions in mm

P	●
M	○
K	○
N	○
S	○
H	-

HM-Sorten
Carbide grades



Schnittdaten DPK Ø 1,5 - 20,0 mm

Cutting Data DPK Ø 1,5 - 20,0 mm

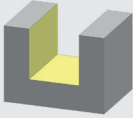
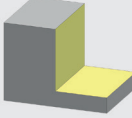

A

	 $v_c = \text{m/min}$	 $v_c = \text{m/min}$
P1.1	130	160
P1.2	120	140
P1.3	120	140
P2.1	110	130
P2.2	110	130
P2.3	110	130
P3.1	100	120
P3.2	100	120

d_1							
		f_z	a_e	a_p	f_z	a_e	a_p
1,5	5°	0,010	0,45	0,45	0,016	0,02	0,08
2,0	5°	0,013	0,60	0,60	0,020	0,03	0,10
2,5	5°	0,016	0,75	0,75	0,024	0,04	0,13
3,0	5°	0,019	0,90	0,90	0,027	0,05	0,15
3,5	5°	0,022	1,05	1,05	0,031	0,05	0,18
4,0	5°	0,024	1,20	1,20	0,035	0,06	0,20
4,5	5°	0,027	1,35	1,35	0,038	0,07	0,23
5,0	5°	0,030	1,50	1,50	0,042	0,08	0,25
6,0	5°	0,036	1,80	1,80	0,050	0,09	0,30
8,0	5°	0,048	2,40	2,40	0,064	0,12	0,40
10,0	5°	0,060	3,00	3,00	0,079	0,15	0,50
12,0	5°	0,072	3,60	3,60	0,094	0,18	0,60
14,0	5°	0,084	4,20	4,20	0,109	0,21	0,70
16,0	5°	0,095	4,80	4,80	0,124	0,24	0,80
20,0	5°	0,119	6,00	6,00	0,153	0,30	1,00

Abmessungen in mm
Dimensions in mm

DPK

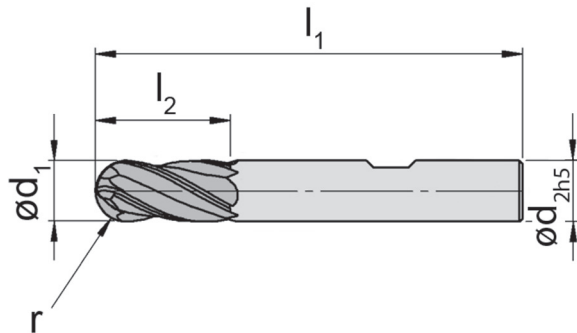
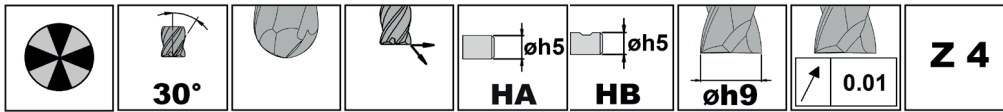

Bestellnummer Part number	d ₁	r	l ₂	d ₂	l ₁	Z	Ausführung Version	TF2K
DPK.4.010.03.03	1,0	0,50	3	3	40	4	HA	▲
DPK.4.015.03.05	1,5	0,75	5	3	40	4	HA	▲
DPK.4.020.03.07	2,0	1,00	7	3	40	4	HA	▲
DPK.4.025.03.07	2,5	1,25	7	3	40	4	HA	▲
DPK.4.030.03.10	3,0	1,50	10	3	40	4	HA	▲
DPK.4.035.04.12	3,5	1,75	12	4	50	4	HA	▲
DPK.4.040.04.15	4,0	2,00	15	4	50	4	HA	▲
DPK.4.050.05.15	5,0	2,50	15	5	50	4	HA	▲
DPK.4.060.06.20	6,0	3,00	20	6	65	4	HB	▲
DPK.4.080.08.20	8,0	4,00	20	8	65	4	HB	▲
DPK.4.100.10.22	10,0	5,00	22	10	70	4	HB	▲
DPK.4.120.12.25	12,0	6,00	25	12	80	4	HB	▲
DPK.4.160.16.32	16,0	8,00	32	16	90	4	HB	▲
DPK.4.200.20.38	20,0	10,00	38	20	100	4	HB	▲

▲ ab Lager / on stock Δ 4 Wochen / 4 weeks x auf Anfrage / upon request

● empfohlen / recommended

o bedingt einsetzbar / alternative recommendation

- nicht geeignet / not suitable

■ unbeschichtete HM-Sorten / uncoated grades

■ beschichtete HM-Sorten / coated grades

■ bestückt/Cermet / brazed/Cermet

Abmessungen in mm

Dimensions in mm

P	●
M	○
K	○
N	○
S	○
H	-

HM-Sorten
Carbide grades



Schnittdaten DPK Ø 1,0 - 20,0 mm

Cutting Data DPK Ø 1,0 - 20,0 mm

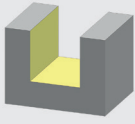
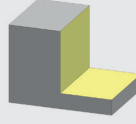

A

	 $v_c = \text{m/min}$	 $v_c = \text{m/min}$
P1.1	130	160
P1.2	120	140
P1.3	120	140
P2.1	110	130
P2.2	110	130
P2.3	110	130
P3.1	100	120
P3.2	100	120

d_1							
		f_z	a_e	a_p	f_z	a_e	a_p
1,0	4°	0,002	0,30	0,30	0,007	0,02	0,05
1,5	4°	0,005	0,45	0,45	0,011	0,02	0,08
2,0	4°	0,008	0,60	0,60	0,015	0,03	0,10
2,5	4°	0,011	0,75	0,75	0,018	0,04	0,13
3,0	4°	0,014	0,90	0,90	0,022	0,05	0,15
3,5	4°	0,017	1,05	1,05	0,026	0,05	0,18
4,0	4°	0,020	1,20	1,20	0,029	0,06	0,20
5,0	4°	0,026	1,50	1,50	0,037	0,08	0,25
6,0	4°	0,032	1,80	1,80	0,044	0,09	0,30
8,0	4°	0,043	2,40	2,40	0,059	0,12	0,40
10,0	4°	0,055	3,00	3,00	0,074	0,15	0,50
12,0	4°	0,067	3,60	3,60	0,089	0,18	0,60
16,0	4°	0,091	4,80	4,80	0,118	0,24	0,80
20,0	4°	0,114	6,00	6,00	0,148	0,30	1,00

Abmessungen in mm
Dimensions in mm

DPFF

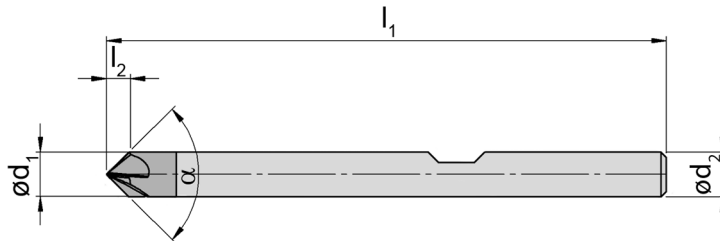
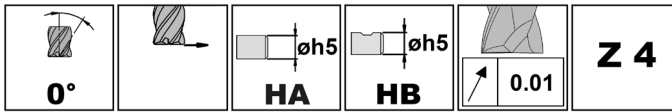

Bestellnummer Part number	d ₁	α	l ₂	l ₃	d ₂	l ₁	Z	Ausführung Type	TF2K
DPFF.4.04.035.060	4	60°	3,5	3,5	4	51	4	HA	▲
DPFF.4.06.052.060	6		5,2	5,2	6	64	4	HB	▲
DPFF.4.08.069.060	8		6,9	6,9	8	64	4	HB	▲
DPFF.4.10.087.060	10		8,7	8,7	10	70	4	HB	▲
DPFF.4.12.104.060	12		10,4	10,4	12	78	4	HB	▲
DPFF.4.04.020.090	4	90°	2,0	2,0	4	51	4	HA	▲
DPFF.4.06.030.090	6		3,0	3,0	6	64	4	HB	▲
DPFF.4.08.040.090	8		4,0	4,0	8	64	4	HB	▲
DPFF.4.10.050.090	10		5,0	5,0	10	70	4	HB	▲
DPFF.4.12.060.090	12		6,0	6,0	12	78	4	HB	▲
DPFF.4.04.011.120	4	120°	1,1	1,1	4	51	4	HA	▲
DPFF.4.06.017.120	6		1,7	1,7	6	64	4	HB	▲
DPFF.4.08.023.120	8		2,3	2,3	8	64	4	HB	▲
DPFF.4.10.028.120	10		2,8	2,8	10	70	4	HB	▲
DPFF.4.12.034.120	12		3,4	3,4	12	78	4	HB	▲

▲ ab Lager / on stock Δ 4 Wochen / 4 weeks x auf Anfrage / upon request

● empfohlen / recommended

o bedingt einsetzbar / alternative recommendation

- nicht geeignet / not suitable

■ unbeschichtete HM-Sorten / uncoated grades

■ beschichtete HM-Sorten / coated grades

■ bestückt/Cermet / brazed/Cermet

Abmessungen in mm

Dimensions in mm

P	●
M	○
K	○
N	○
S	○
H	-

HM-Sorten
Carbide grades



Schnittdaten DFF Ø 4,0 - 12,0 mm

Cutting Data DPT Ø 4,0 - 12,0 mm

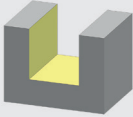
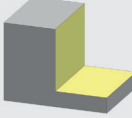

A

	 $v_c = \text{m/min}$	 $v_c = \text{m/min}$
P1.1	130	160
P1.2	120	140
P1.3	120	140
P2.1	110	130
P2.2	110	130
P2.3	110	130
P3.1	100	120
P3.2	100	120

d_1						
	f_z	a_e	a_p	f_z	a_e	a_p
4	0,021	1,00	1,00	0,038	0,10	0,10
6	0,026	1,50	1,50	0,062	0,09	0,30
8	0,031	2,00	2,00	0,059	0,20	0,20
10	0,036	2,50	2,50	0,089	0,15	0,50
12	0,041	3,00	3,00	0,080	0,30	0,30
4	0,021	1,00	1,00	0,049	0,06	0,20
6	0,026	1,50	1,50	0,048	0,15	0,15
8	0,031	2,00	2,00	0,076	0,12	0,40
10	0,036	2,50	2,50	0,069	0,25	0,25
12	0,041	3,00	3,00	0,103	0,18	0,60
4	0,021	1,00	1,00	0,038	0,10	0,10
6	0,026	1,50	1,50	0,062	0,09	0,30
8	0,031	2,00	2,00	0,059	0,20	0,20
10	0,036	2,50	2,50	0,089	0,15	0,50
12	0,041	3,00	3,00	0,080	0,30	0,30

Abmessungen in mm
Dimensions in mm





bgestimmt für:

Seite/page

hochfeste Stähle
high tensile steels

B2-B71

gehärtete Stähle
hardened steels

B72-B115

Kobalt-Chrom-Stähle
Cobalt Chromium Steels

B116-B125

Titan
Titanium

B126-B151

Aluminium
Aluminum















B152-B187

Vollhartmetall-Schafffräser

Solid Carbide End Mills



B

	DSKM	Schafffräser Vollradius Mikro Ball Nose End Mill Micro	Ø 0,1 – Ø 3,0	Z 2	B3 – B7
	DSTM.2	Torusfräser Mikro Torus End Mill Micro	Ø 0,1 – Ø 3,0	Z 2	B8 – B17
	DSTM.4	Torusfräser Mikro Torus End Mill Micro	Ø 0,2 – Ø 3,0	Z 4	B18 – B27
	DSK	Schafffräser Vollradius Ball Nose End Mill	Ø 3,5 – Ø 16,0	Z 2	B28 – B29
	DST.2	Torusfräser Torus End Mill	Ø 3,5 – Ø 16,0	Z 2	B30 – B37
	DST.4	Torusfräser Torus End Mill	Ø 3,5 – Ø 16,0	Z 4	B38 – B45
	DSM	Schafffräser Mehrschneider End Mill multiple fluted	Ø 2,0 – Ø 20,0	Z 6-8	B46 – B49
	DSMR	Schafffräser Mehrschneider, Eckenradius End Mill multiple fluted, corner radius	Ø 2,0 – Ø 20,0	Z 6-8	B50– B57
	DSR.3	Schrupfräser, Eckradius Roughing End Mill, corner radius	Ø 2,0 – Ø 16,0	Z 3	B58 – B59
	DSF.3	Schrupfräser, Eckfase Roughing End Mill, chamfer	Ø 2,0 – Ø 16,0	Z 3	B60 – B61
	DSF.4	Schrupfräser, Eckfase Roughing End Mill, chamfer	Ø 4,0 – Ø 16,0	Z 4	B62 – B63
	DSFT	Schafffräser Trochoidalfräsen End Mill Trochoidal Milling	Ø 2,0 – Ø 20,0	Z 4-7	B64 – B67
	DSH	Hochvorschubfräser High Feed End Mill	Ø 2,0 – Ø 16,0	Z 4	B68 – B69
	DSFF	Fasfräser 90° Chamfering End Mill 90°	Ø 4,0 – Ø 12,0	Z 4	B70 – B71

DS

B



abgestimmt für:

- hochfeste Stähle

designed for:

- high tensile steels

Mikrofräser Vollradius

Micro End Mill Ballnose



DSKM

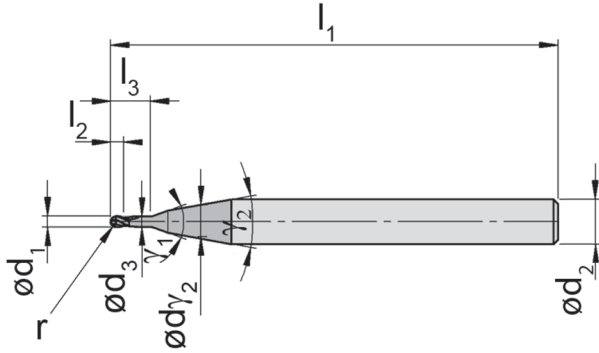
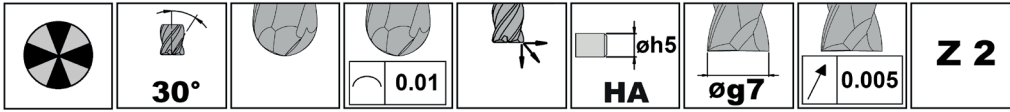

Bestellnummer Part number	d ₁	r	l ₂	l ₃	d ₃	d ₂	l ₁	Z	γ1	γ2	TS3K
DSKM.2.010.030	0,1	0,05	0,2	0,3	0,08	4	50	2	20°	-	▲
DSKM.2.010.050	0,1	0,05	0,2	0,5	0,08	4	50	2	40°	20°	▲
DSKM.2.010.070	0,1	0,05	0,2	0,7	0,08	4	50	2	40°	20°	▲
DSKM.2.020.030	0,2	0,10	0,4	0,6	0,18	4	50	2	20°	-	▲
DSKM.2.020.050	0,2	0,10	0,4	1,0	0,18	4	50	2	40°	20°	▲
DSKM.2.020.070	0,2	0,10	0,4	1,4	0,18	4	50	2	40°	20°	▲
DSKM.2.030.030	0,3	0,15	0,6	0,9	0,28	4	50	2	20°	-	▲
DSKM.2.030.050	0,3	0,15	0,6	1,5	0,28	4	50	2	40°	20°	▲
DSKM.2.030.070	0,3	0,15	0,6	2,1	0,28	4	50	2	40°	20°	▲
DSKM.2.040.030	0,4	0,20	0,8	1,2	0,35	4	50	2	20°	-	▲
DSKM.2.040.050	0,4	0,20	0,8	2,0	0,35	4	50	2	40°	20°	▲
DSKM.2.040.070	0,4	0,20	0,8	2,8	0,35	4	50	2	40°	20°	▲
DSKM.2.050.030	0,5	0,25	1,0	1,5	0,47	4	50	2	20°	-	▲
DSKM.2.050.050	0,5	0,25	1,0	2,5	0,47	4	50	2	40°	20°	▲
DSKM.2.050.070	0,5	0,25	1,0	3,5	0,47	4	50	2	40°	20°	▲
DSKM.2.060.030	0,6	0,30	1,2	1,8	0,55	4	50	2	20°	-	▲
DSKM.2.060.050	0,6	0,30	1,2	3,0	0,55	4	50	2	40°	20°	▲
DSKM.2.060.070	0,6	0,30	1,2	4,2	0,55	4	50	2	40°	20°	▲
DSKM.2.070.030	0,7	0,35	1,4	2,1	0,65	4	50	2	20°	-	▲
DSKM.2.070.050	0,7	0,35	1,4	3,5	0,65	4	50	2	40°	20°	▲
DSKM.2.070.070	0,7	0,35	1,4	4,9	0,65	4	50	2	40°	20°	▲
DSKM.2.080.030	0,8	0,40	1,6	2,4	0,75	4	50	2	20°	-	▲
DSKM.2.080.050	0,8	0,40	1,6	4,0	0,75	4	50	2	40°	20°	▲
DSKM.2.080.070	0,8	0,40	1,6	5,6	0,75	4	50	2	40°	20°	▲

▲ ab Lager / on stock Δ 4 Wochen / 4 weeks x auf Anfrage / upon request

● empfohlen / recommended

○ bedingt einsetzbar / alternative recommendation

- nicht geeignet / not suitable

■ unbeschichtete HM-Sorten / uncoated grades

■ beschichtete HM-Sorten / coated grades

■ bestückt/Cermet / brazed/Cermet

Abmessungen in mm

Dimensions in mm



P	●
M	○
K	○
N	-
S	○
H	○



HM-Sorten
Carbide grades

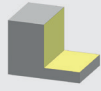

Schnittdaten DSKM Ø 0,1 - 0,8 mm

Cutting Data DSKM Ø 0,1 - 0,8 mm

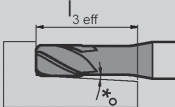
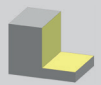

	 $vc = m/min$	 $vc = m/min$
P1.1	160	190
P1.2	160	190
P1.3	150	180
P2.1	140	170
P2.2	140	170
P2.3	140	170
P3.1	120	140
P3.2	110	130
M1.1	90	110
M2.1	80	100
M3.1	60	70

	 $vc = m/min$	 $vc = m/min$
K1.1	140	170
K1.2	130	160
K2.1	120	140
K2.2	100	120
K3.1	80	100
K3.2	70	80
S1	70	80
S2	55	70
S3	40	50
-	-	-
-	-	-

d_1	 α	 $l_{3\text{eff}}$										
		0°	0,5°	1°	2°	3°	f_z	a_e	a_p	f_z	a_e	a_p
0,1	5°	0,3	0,3	0,3	0,3	0,4	0,004	0,01	0,02	0,005	0,01	0,01
0,1	5°	0,5	0,5	0,5	0,5	0,5	0,003	0,01	0,02	0,005	0,01	0,01
0,1	3°	0,7	0,7	0,7	0,7	0,8	0,003	0,01	0,01	0,004	0,01	0,01
0,2	5°	0,6	0,6	0,6	0,7	0,8	0,004	0,02	0,04	0,006	0,01	0,02
0,2	5°	1,0	1,0	1,0	1,1	1,1	0,004	0,02	0,03	0,005	0,01	0,02
0,2	3°	1,4	1,4	1,4	1,5	1,6	0,003	0,02	0,02	0,005	0,01	0,01
0,3	5°	0,9	0,9	0,9	1,0	1,2	0,005	0,03	0,06	0,007	0,02	0,03
0,3	5°	1,5	1,5	1,5	1,6	1,7	0,004	0,03	0,05	0,006	0,02	0,02
0,3	3°	2,1	2,1	2,2	2,3	2,4	0,004	0,03	0,03	0,006	0,02	0,02
0,4	5°	1,2	1,2	1,2	1,3	1,5	0,006	0,04	0,08	0,008	0,02	0,04
0,4	5°	2,0	2,0	2,0	2,1	2,2	0,005	0,04	0,06	0,007	0,02	0,03
0,4	3°	2,8	2,8	2,9	3,0	3,1	0,004	0,04	0,04	0,006	0,02	0,02
0,5	5°	1,5	1,5	1,6	1,8	2,0	0,006	0,05	0,10	0,009	0,03	0,05
0,5	5°	2,5	2,5	2,6	2,7	2,8	0,006	0,05	0,08	0,008	0,03	0,04
0,5	3°	3,5	3,5	3,6	3,8	4,0	0,005	0,05	0,05	0,007	0,03	0,03
0,6	5°	1,8	1,8	1,9	2,1	2,4	0,007	0,06	0,12	0,010	0,03	0,06
0,6	5°	3,0	3,0	3,1	3,2	3,4	0,006	0,06	0,09	0,009	0,03	0,05
0,6	3°	4,2	4,3	4,4	4,6	4,8	0,005	0,06	0,06	0,008	0,03	0,04
0,7	5°	2,1	2,1	2,2	2,4	2,7	0,007	0,07	0,14	0,010	0,04	0,07
0,7	5°	3,5	3,5	3,6	3,7	3,9	0,007	0,07	0,11	0,009	0,04	0,06
0,7	3°	4,9	5,0	5,1	5,3	5,5	0,006	0,07	0,07	0,008	0,04	0,04
0,8	5°	2,4	2,5	2,6	2,9	3,2	0,008	0,08	0,16	0,011	0,04	0,08
0,8	5°	4,0	4,0	4,1	4,3	4,6	0,007	0,08	0,12	0,010	0,04	0,06
0,8	3°	5,6	5,7	5,8	6,1	6,4	0,006	0,08	0,08	0,009	0,04	0,05

Abmessungen in mm
Dimensions in mm

B

Mikrofräser Vollradius

Micro End Mill Ballnose



DSKM

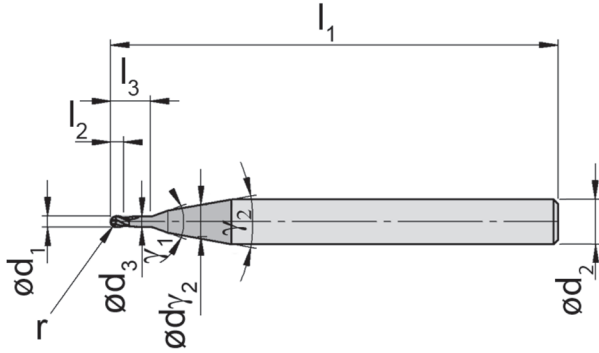
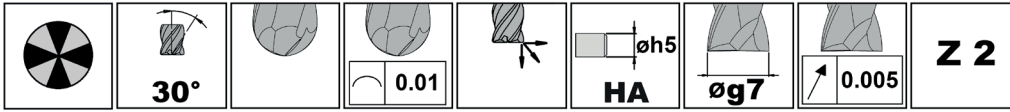

Bis Ø 3 mm vormontiert lieferbar für Toodle Schnelllaufspindel
Pre-assembled available up to Ø 3 mm for Toodle high-speed spindle

Bestellnummer Part number	d ₁	r	l ₂	l ₃	d ₃	d ₂	l ₁	Z	γ ₁	γ ₂	TS3K
DSKM.2.090.030	0,9	0,45	1,8	2,7	0,85	4	50	2	20°	-	▲
DSKM.2.090.050	0,9	0,45	1,8	4,5	0,85	4	50	2	40°	20°	▲
DSKM.2.090.070	0,9	0,45	1,8	6,3	0,85	4	50	2	40°	20°	▲
DSKM.2.100.030	1,0	0,50	2,0	3,0	0,95	4	50	2	20°	-	▲
DSKM.2.100.050	1,0	0,50	2,0	5,0	0,95	4	50	2	40°	20°	▲
DSKM.2.100.070	1,0	0,50	2,0	7,0	0,95	4	50	2	40°	20°	▲
DSKM.2.120.030	1,2	0,60	2,4	3,6	1,15	4	50	2	20°	-	▲
DSKM.2.120.050	1,2	0,60	2,4	6,0	1,15	4	50	2	40°	20°	▲
DSKM.2.120.070	1,2	0,60	2,4	8,4	1,15	4	50	2	40°	20°	▲
DSKM.2.150.030	1,5	0,75	3,0	4,5	1,45	4	50	2	20°	-	▲
DSKM.2.150.050	1,5	0,75	3,0	7,5	1,45	4	50	2	40°	20°	▲
DSKM.2.150.070	1,5	0,75	3,0	10,5	1,45	4	50	2	40°	20°	▲
DSKM.2.200.030	2,0	1,00	4,0	6,0	1,90	4	50	2	20°	-	▲
DSKM.2.200.050	2,0	1,00	4,0	10,0	1,90	4	50	2	40°	20°	▲
DSKM.2.200.070	2,0	1,00	4,0	14,0	1,90	4	50	2	40°	20°	▲
DSKM.2.250.030	2,5	1,25	5,0	7,5	2,40	4	50	2	20°	-	▲
DSKM.2.250.050	2,5	1,25	5,0	12,5	2,40	4	50	2	40°	20°	▲
DSKM.2.250.070	2,5	1,25	5,0	17,5	2,40	4	60	2	40°	20°	▲
DSKM.2.300.030	3,0	1,50	6,0	9,0	2,90	4	50	2	20°	-	▲
DSKM.2.300.050	3,0	1,50	6,0	15,0	2,90	4	50	2	40°	20°	▲
DSKM.2.300.070	3,0	1,50	6,0	21,0	2,90	4	60	2	40°	20°	▲

- ▲ ab Lager / on stock Δ 4 Wochen / 4 weeks x auf Anfrage / upon request
- empfohlen / recommended
- o bedingt einsetzbar / alternative recommendation
- nicht geeignet / not suitable
- unbeschichtete HM-Sorten / uncoated grades
- beschichtete HM-Sorten / coated grades
- bestückt/Cermet / brazed/Cermet

P	●
M	○
K	○
N	-
S	○
H	○



Abmessungen in mm
Dimensions in mm



HM-Sorten
Carbide grades

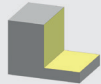

Schnittdaten DSKM Ø 0,9 - 3,0 mm

Cutting Data DSKM Ø 0,9 - 3,0 mm

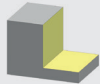

	 $vc = m/min$	 $vc = m/min$
P1.1	160	190
P1.2	160	190
P1.3	150	180
P2.1	140	170
P2.2	140	170
P2.3	140	170
P3.1	120	140
P3.2	110	130
M1.1	90	110
M2.1	80	100
M3.1	60	70

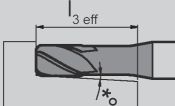
	 $vc = m/min$	 $vc = m/min$
K1.1	140	170
K1.2	130	160
K2.1	120	140
K2.2	100	120
K3.1	80	100
K3.2	70	80
S1	70	80
S2	55	70
S3	40	50
-	-	-
-	-	-

d_1	 α	 $l_{3\text{eff}}$										
		0°	0,5°	1°	2°	3°	f_z	a_e	a_p	f_z	a_e	a_p
0,9	5°	2,7	2,8	2,9	3,2	3,5	0,009	0,09	0,18	0,012	0,05	0,09
0,9	5°	4,5	4,5	4,6	4,8	5,1	0,008	0,09	0,14	0,011	0,05	0,07
0,9	3°	6,3	6,4	6,5	6,8	7,1	0,007	0,09	0,09	0,010	0,05	0,05
1,0	5°	3,0	3,1	3,2	3,6	4	0,009	0,10	0,20	0,013	0,05	0,10
1,0	5°	5,0	5,1	5,2	5,4	5,7	0,008	0,10	0,15	0,012	0,05	0,08
1,0	3°	7,0	7	7,1	7,3	7,4	0,007	0,10	0,10	0,011	0,05	0,06
1,2	5°	3,6	3,7	3,9	4,3	4,8	0,011	0,12	0,24	0,015	0,06	0,12
1,2	5°	6,0	6,1	6,2	6,5	6,9	0,010	0,12	0,18	0,013	0,06	0,10
1,2	3°	8,4	8,5	8,7	9,2	9,8	0,008	0,12	0,12	0,012	0,06	0,07
1,5	5°	4,5	4,7	4,9	5,4	6,1	0,012	0,15	0,30	0,018	0,08	0,15
1,5	5°	7,5	7,6	7,8	8,2	8,6	0,011	0,15	0,23	0,016	0,08	0,12
1,5	3°	10,5	10,7	10,9	11,5	12,3	0,010	0,15	0,15	0,014	0,08	0,09
2,0	5°	6,0	6,2	6,5	7,2	8,1	0,016	0,20	0,40	0,022	0,10	0,20
2,0	5°	10,0	10,2	10,4	10,9	11,5	0,014	0,20	0,30	0,020	0,10	0,16
2,0	3°	14,0	14,3	14,6	15,3	17,2	0,013	0,20	0,20	0,018	0,10	0,12
2,5	5°	7,5	7,8	8,1	9	10,1	0,019	0,25	0,50	0,027	0,13	0,25
2,5	5°	12,5	12,7	13	13,7	∞	0,017	0,25	0,38	0,024	0,13	0,20
2,5	3°	17,5	17,9	18,3	19,5	∞	0,015	0,25	0,25	0,021	0,13	0,15
3,0	5°	9,0	9,3	9,8	10,8	∞	0,022	0,30	0,60	0,031	0,15	0,30
3,0	5°	15,0	15,3	15,6	∞	∞	0,020	0,30	0,45	0,028	0,15	0,24
3,0	3°	21,0	21,4	22,1	∞	∞	0,018	0,30	0,30	0,025	0,15	0,18

Abmessungen in mm
Dimensions in mm

B

Mikrofräser Torus

Micro End Mill Torus



DSTM

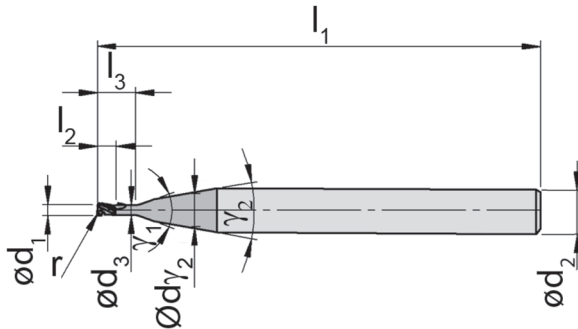
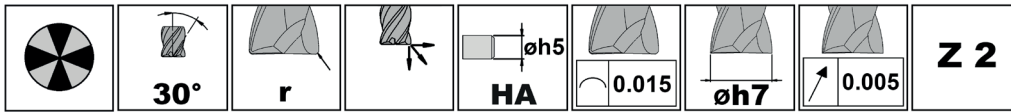

Bestellnummer Part number	d ₁	r	l ₂	l ₃	d ₃	d ₂	l ₁	Z	γ ₁	γ ₂	d ₂	TS3K
DSTM.2.010.000.030	0,1	0	0,2	0,3	0,08	4	50	2	20°	-	-	▲
DSTM.2.010.000.050	0,1	0	0,2	0,5	0,08	4	50	2	40°	20°	1,5	▲
DSTM.2.010.000.070	0,1	0	0,2	0,7	0,08	4	50	2	40°	20°	1,5	▲
DSTM.2.020.000.030	0,2	0	0,4	0,6	0,18	4	50	2	20°	-	-	▲
DSTM.2.020.000.050	0,2	0	0,4	1,0	0,18	4	50	2	40°	20°	1,5	▲
DSTM.2.020.000.070	0,2	0	0,4	1,4	0,18	4	50	2	40°	20°	1,5	▲
DSTM.2.030.000.030	0,3	0	0,6	0,9	0,28	4	50	2	20°	-	-	▲
DSTM.2.030.000.050	0,3	0	0,6	1,5	0,28	4	50	2	40°	20°	1,5	▲
DSTM.2.030.000.070	0,3	0	0,6	2,1	0,28	4	50	2	40°	20°	1,5	▲
DSTM.2.040.000.030	0,4	0	0,7	1,2	0,38	4	50	2	20°	-	-	▲
DSTM.2.040.000.050	0,4	0	0,7	2,0	0,38	4	50	2	40°	20°	1,5	▲
DSTM.2.040.000.070	0,4	0	0,7	2,8	0,38	4	50	2	40°	20°	1,5	▲
DSTM.2.050.000.030	0,5	0	1,0	1,5	0,47	4	50	2	20°	-	-	▲
DSTM.2.050.000.050	0,5	0	1,0	2,5	0,47	4	50	2	40°	20°	1,5	▲
DSTM.2.050.000.070	0,5	0	1,0	3,5	0,47	4	50	2	40°	20°	1,5	▲
DSTM.2.050.010.030	0,5	0,1	1,0	1,5	0,47	4	50	2	20°	-	-	▲
DSTM.2.050.010.050	0,5	0,1	1,0	2,5	0,47	4	50	2	40°	20°	1,5	▲
DSTM.2.050.010.070	0,5	0,1	1,0	3,5	0,47	4	50	2	40°	20°	1,5	▲
DSTM.2.060.000.030	0,6	0	1,2	1,8	0,60	4	50	2	20°	-	-	▲
DSTM.2.060.000.050	0,6	0	1,2	3,0	0,55	4	50	2	40°	20°	1,5	▲
DSTM.2.060.000.070	0,6	0	1,2	4,2	0,55	4	50	2	40°	20°	1,5	▲
DSTM.2.060.010.030	0,6	0,1	1,2	1,8	0,55	4	50	2	20°	-	-	▲
DSTM.2.060.010.050	0,6	0,1	1,2	3,0	0,55	4	50	2	40°	20°	1,5	▲
DSTM.2.060.010.070	0,6	0,1	1,2	4,2	0,55	4	50	2	40°	20°	1,5	▲

▲ ab Lager / on stock Δ 4 Wochen / 4 weeks x auf Anfrage / upon request

● empfohlen / recommended

○ bedingt einsetzbar / alternative recommendation

- nicht geeignet / not suitable

■ unbeschichtete HM-Sorten / uncoated grades

■ beschichtete HM-Sorten / coated grades

■ bestückt/Cermet / brazed/Cermet

Abmessungen in mm

Dimensions in mm



P	●
M	○
K	○
N	-
S	○
H	○



HM-Sorten
Carbide grades

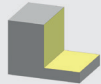

Schnittdaten DSTM Ø 0,1 - 0,6 mm

Cutting Data DSTM Ø 0,1 - 0,6 mm

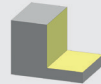

	 $vc = m/min$	 $vc = m/min$
P1.1	160	190
P1.2	160	190
P1.3	150	180
P2.1	140	170
P2.2	140	170
P2.3	140	170
P3.1	120	140
P3.2	110	130
M1.1	90	110
M2.1	80	100
M3.1	60	70

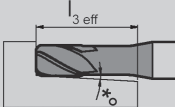
	 $vc = m/min$	 $vc = m/min$
K1.1	140	170
K1.2	130	160
K2.1	120	140
K2.2	100	120
K3.1	80	100
K3.2	70	80
S1	70	80
S2	55	70
S3	40	50
-	-	-
-	-	-

d_1	 α	 $l_{3\text{eff}}$										
		0°	0,5°	1°	2°	3°	f_z	a_e	a_p	f_z	a_e	a_p
0,1	5°	0,3	0,3	0,3	0,3	0,4	0,004	0,01	0,02	0,005	0,01	0,01
0,1	5°	0,5	0,5	0,5	0,5	0,5	0,003	0,01	0,02	0,005	0,01	0,01
0,1	3°	0,7	0,7	0,7	0,8	0,9	0,003	0,01	0,01	0,004	0,01	0,01
0,2	5°	0,6	0,6	0,6	0,7	0,8	0,004	0,02	0,04	0,006	0,01	0,02
0,2	5°	1,0	1	1	1,1	1,1	0,004	0,02	0,03	0,005	0,01	0,02
0,2	3°	1,4	1,4	1,4	1,5	1,6	0,003	0,02	0,02	0,005	0,01	0,01
0,3	5°	0,9	0,9	0,9	1,1	1,2	0,005	0,03	0,06	0,007	0,02	0,03
0,3	5°	1,5	1,5	1,5	1,6	1,7	0,004	0,03	0,05	0,006	0,02	0,02
0,3	3°	2,1	2,1	2,2	2,3	2,4	0,004	0,03	0,03	0,006	0,02	0,02
0,4	5°	1,2	1,2	1,2	1,4	1,5	0,006	0,04	0,08	0,008	0,02	0,04
0,4	5°	2,0	2	2	2,1	2,2	0,005	0,04	0,06	0,007	0,02	0,03
0,4	3°	2,8	2,8	2,9	3	3,1	0,004	0,04	0,04	0,006	0,02	0,02
0,5	5°	1,5	1,5	1,6	1,8	2,1	0,006	0,05	0,10	0,009	0,03	0,05
0,5	5°	2,5	2,5	2,6	2,7	2,9	0,006	0,05	0,08	0,008	0,03	0,04
0,5	3°	3,5	3,5	3,6	3,8	4	0,005	0,05	0,05	0,007	0,03	0,03
0,5	5°	1,5	1,5	1,6	1,8	2	0,006	0,05	0,10	0,009	0,03	0,05
0,5	5°	2,5	2,5	2,6	2,7	2,9	0,006	0,05	0,08	0,008	0,03	0,04
0,5	3°	3,5	3,5	3,6	3,8	4	0,005	0,05	0,05	0,007	0,03	0,03
0,6	5°	1,8	1,8	1,9	2,2	2,5	0,007	0,06	0,12	0,010	0,03	0,06
0,6	5°	3,0	3	3,1	3,3	3,5	0,006	0,06	0,09	0,009	0,03	0,05
0,6	3°	4,2	4,2	4,4	4,6	4,9	0,005	0,06	0,06	0,008	0,03	0,04
0,6	5°	1,8	1,8	1,9	2,2	2,5	0,007	0,06	0,12	0,010	0,03	0,06
0,6	5°	3,0	3	3,1	3,3	3,4	0,006	0,06	0,09	0,009	0,03	0,05
0,6	3°	4,2	4,2	4,4	4,6	4,8	0,005	0,06	0,06	0,008	0,03	0,04

Abmessungen in mm
Dimensions in mm

B

Mikrofräser Torus

Micro End Mill Torus



DSTM

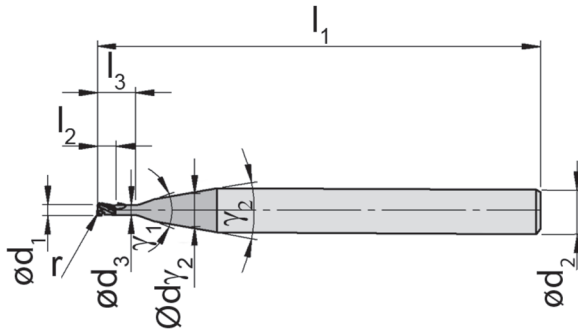
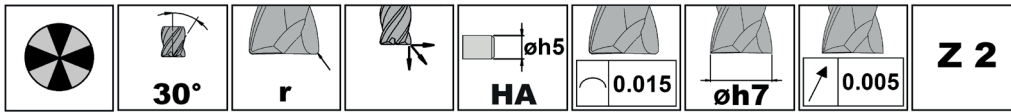

Bestellnummer Part number	d ₁	r	l ₂	l ₃	d ₃	d ₂	l ₁	Z	γ ₁	γ ₂	d _{v2}	TS3K
DSTM.2.070.000.030	0,7	0	1,4	2,1	0,65	4	50	2	20°	-	-	▲
DSTM.2.070.000.050	0,7	0	1,4	3,5	0,65	4	50	2	40°	20°	1,5	▲
DSTM.2.070.000.070	0,7	0	1,4	4,9	0,65	4	50	2	40°	20°	1,5	▲
DSTM.2.070.010.030	0,7	0,1	1,4	2,1	0,65	4	50	2	20°	-	-	▲
DSTM.2.070.010.050	0,7	0,1	1,4	3,5	0,65	4	50	2	40°	20°	1,5	▲
DSTM.2.070.010.070	0,7	0,1	1,4	4,9	0,65	4	50	2	40°	20°	1,5	▲
DSTM.2.080.000.030	0,8	0	1,6	2,4	0,75	4	50	2	20°	-	-	▲
DSTM.2.080.000.050	0,8	0	1,6	4,0	0,75	4	50	2	40°	20°	1,5	▲
DSTM.2.080.000.070	0,8	0	1,6	5,6	0,75	4	50	2	40°	20°	1,5	▲
DSTM.2.080.010.030	0,8	0,1	1,6	2,4	0,75	4	50	2	20°	-	-	▲
DSTM.2.080.010.050	0,8	0,1	1,6	4,0	0,75	4	50	2	40°	20°	1,5	▲
DSTM.2.080.010.070	0,8	0,1	1,6	5,6	0,75	4	50	2	40°	20°	1,5	▲
DSTM.2.090.000.030	0,9	0	1,8	2,7	0,85	4	50	2	20°	-	-	▲
DSTM.2.090.000.050	0,9	0	1,8	4,5	0,85	4	50	2	40°	20°	1,5	▲
DSTM.2.090.000.070	0,9	0	1,8	6,3	0,85	4	50	2	40°	20°	1,5	▲
DSTM.2.090.010.030	0,9	0,1	1,8	2,7	0,85	4	50	2	20°	-	-	▲
DSTM.2.090.010.050	0,9	0,1	1,8	4,5	0,85	4	50	2	40°	20°	1,5	▲
DSTM.2.090.010.070	0,9	0,1	1,8	6,3	0,85	4	50	2	40°	20°	1,5	▲
DSTM.2.100.000.030	1,0	0	2,0	3,0	0,95	4	50	2	20°	-	-	▲
DSTM.2.100.000.050	1,0	0	2,0	5,0	0,95	4	50	2	40°	20°	2,0	▲
DSTM.2.100.000.070	1,0	0	2,0	7,0	0,95	4	50	2	40°	20°	2,0	▲
DSTM.2.100.010.030	1,0	0,1	2,0	3,0	0,95	4	50	2	20°	-	-	▲
DSTM.2.100.010.050	1,0	0,1	2,0	5,0	0,95	4	50	2	40°	20°	2,0	▲
DSTM.2.100.010.070	1,0	0,1	2,0	7,0	0,95	4	50	2	40°	20°	2,0	▲
DSTM.2.100.020.030	1,0	0,2	2,0	3,0	0,95	4	50	2	20°	-	-	▲
DSTM.2.100.020.050	1,0	0,2	2,0	5,0	0,95	4	50	2	40°	20°	2,0	▲
DSTM.2.100.020.070	1,0	0,2	2,0	7,0	0,95	4	50	2	40°	20°	2,0	▲

▲ ab Lager / on stock Δ 4 Wochen / 4 weeks x auf Anfrage / upon request

● empfohlen / recommended

o bedingt einsetzbar / alternative recommendation

- nicht geeignet / not suitable

■ unbeschichtete HM-Sorten / uncoated grades

■ beschichtete HM-Sorten / coated grades

■ bestückt/Cermet / brazed/Cermet

Abmessungen in mm

Dimensions in mm



P	●
M	○
K	○
N	-
S	○
H	○



HM-Sorten
Carbide grades

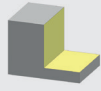

Schnittdaten DSTM Ø 0,7 - 1,0 mm

Cutting Data DSTM Ø 0,7 - 1,0 mm

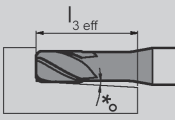

	 $vc = m/min$	 $vc = m/min$
P1.1	160	190
P1.2	160	190
P1.3	150	180
P2.1	140	170
P2.2	140	170
P2.3	140	170
P3.1	120	140
P3.2	110	130
M1.1	90	110
M2.1	80	100
M3.1	60	70

	 $vc = m/min$	 $vc = m/min$
K1.1	140	170
K1.2	130	160
K2.1	120	140
K2.2	100	120
K3.1	80	100
K3.2	70	80
S1	70	80
S2	55	70
S3	40	50
-	-	-
-	-	-

d_1												
		0°	0,5°	1°	2°	3°	f_z	a_e	a_p	f_z	a_e	a_p
0,7	5°	2,1	2,1	2,2	2,5	2,8	0,007	0,07	0,14	0,010	0,04	0,07
0,7	5°	3,5	3,5	3,6	3,8	3,9	0,007	0,07	0,11	0,009	0,04	0,06
0,7	3°	4,9	4,9	5,1	5,3	5,5	0,006	0,07	0,07	0,008	0,04	0,04
0,7	5°	2,1	2,1	2,2	2,5	2,8	0,007	0,07	0,14	0,010	0,04	0,07
0,7	5°	3,5	3,5	3,6	3,8	3,9	0,007	0,07	0,11	0,009	0,04	0,06
0,7	3°	4,9	4,9	5,1	5,3	5,5	0,006	0,07	0,07	0,008	0,04	0,04
0,8	5°	2,4	2,5	2,6	2,9	3,3	0,008	0,08	0,16	0,011	0,04	0,08
0,8	5°	4,0	4	4,2	4,4	4,6	0,007	0,08	0,12	0,010	0,04	0,06
0,8	3°	5,6	5,7	5,8	6,1	6,5	0,006	0,08	0,08	0,009	0,04	0,05
0,8	5°	2,4	2,5	2,6	2,9	3,3	0,008	0,08	0,16	0,011	0,04	0,08
0,8	5°	4,0	4	4,2	4,4	4,6	0,007	0,08	0,12	0,010	0,04	0,06
0,8	3°	5,6	5,7	5,8	6,1	6,5	0,006	0,08	0,08	0,009	0,04	0,05
0,9	5°	2,7	2,8	2,9	3,2	3,6	0,009	0,09	0,18	0,012	0,05	0,09
0,9	5°	4,5	4,5	4,7	4,9	5,1	0,008	0,09	0,14	0,011	0,05	0,07
0,9	3°	6,3	6,4	6,5	6,8	7,2	0,007	0,09	0,09	0,010	0,05	0,05
0,9	5°	2,7	2,8	2,9	3,2	3,6	0,009	0,09	0,18	0,012	0,05	0,09
0,9	5°	4,5	4,5	4,7	4,9	5,1	0,008	0,09	0,14	0,011	0,05	0,07
0,9	3°	6,3	6,4	6,5	6,8	7,2	0,007	0,09	0,09	0,010	0,05	0,05
1,0	5°	3,0	3,1	3,3	3,7	4,2	0,009	0,10	0,20	0,013	0,05	0,10
1,0	5°	5,0	5,1	5,2	5,5	5,8	0,008	0,10	0,15	0,012	0,05	0,08
1,0	3°	7,0	7,1	7,3	7,7	8,1	0,007	0,10	0,10	0,011	0,05	0,06
1,0	5°	3,0	3,1	3,3	3,7	4,2	0,009	0,10	0,20	0,013	0,05	0,10
1,0	5°	5,0	5,1	5,2	5,5	5,8	0,008	0,10	0,15	0,012	0,05	0,08
1,0	3°	7,0	7,1	7,3	7,7	8,1	0,007	0,10	0,10	0,011	0,05	0,06
1,0	5°	3,0	3,1	3,3	3,7	4,2	0,009	0,10	0,20	0,013	0,05	0,10
1,0	5°	5,0	5,1	5,2	5,5	5,8	0,008	0,10	0,15	0,012	0,05	0,08
1,0	3°	7,0	7,1	7,3	7,7	8,1	0,007	0,10	0,10	0,011	0,05	0,06

Abmessungen in mm
Dimensions in mm

B

Mikrofräser Torus

Micro End Mill Torus



DSTM

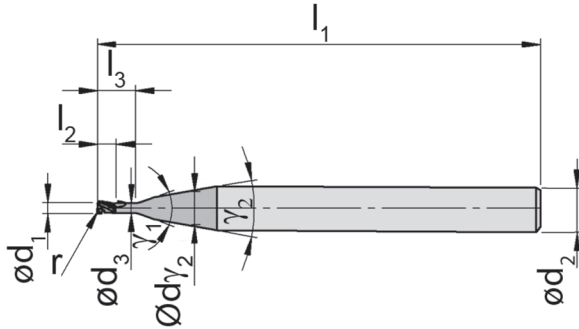
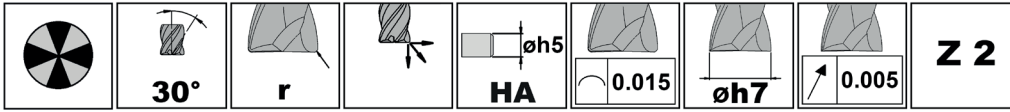

Bestellnummer Part number	d ₁	r	l ₂	l ₃	d ₃	d ₂	l ₁	Z	γ ₁	γ ₂	d _{v2}	TS3K
DSTM.2.120.000.030	1,2	0	2,4	3,6	1,15	4	50	2	20°	-	-	▲
DSTM.2.120.000.050	1,2	0	2,4	6,0	1,15	4	50	2	40°	20°	2,0	▲
DSTM.2.120.000.070	1,2	0	2,4	8,4	1,15	4	50	2	40°	20°	2,0	▲
DSTM.2.120.010.030	1,2	0,1	2,4	3,6	1,15	4	50	2	20°	-	-	▲
DSTM.2.120.010.050	1,2	0,1	2,4	6,0	1,15	4	50	2	40°	20°	2,0	▲
DSTM.2.120.010.070	1,2	0,1	2,4	8,4	1,15	4	50	2	40°	20°	2,0	▲
DSTM.2.120.020.030	1,2	0,2	2,4	3,6	1,15	4	50	2	20°	-	-	▲
DSTM.2.120.020.050	1,2	0,2	2,4	6,0	1,15	4	50	2	40°	20°	2,0	▲
DSTM.2.120.020.070	1,2	0,2	2,4	8,4	1,15	4	50	2	40°	20°	2,0	▲
DSTM.2.150.000.030	1,5	0	3,0	4,5	1,45	4	50	2	20°	-	-	▲
DSTM.2.150.000.050	1,5	0	3,0	7,5	1,45	4	50	2	40°	20°	2,5	▲
DSTM.2.150.000.070	1,5	0	3,0	10,5	1,45	4	50	2	40°	20°	2,5	▲
DSTM.2.150.010.030	1,5	0,1	3,0	4,5	1,45	4	50	2	20°	-	-	▲
DSTM.2.150.010.050	1,5	0,1	3,0	7,5	1,45	4	50	2	40°	20°	2,5	▲
DSTM.2.150.010.070	1,5	0,1	3,0	10,5	1,45	4	50	2	40°	20°	2,5	▲
DSTM.2.150.020.030	1,5	0,2	3,0	4,5	1,45	4	50	2	20°	-	-	▲
DSTM.2.150.020.050	1,5	0,2	3,0	7,5	1,45	4	50	2	40°	20°	2,5	▲
DSTM.2.150.020.070	1,5	0,2	3,0	10,5	1,45	4	50	2	40°	20°	2,5	▲
DSTM.2.150.050.030	1,5	0,5	3,0	4,5	1,45	4	50	2	20°	-	-	▲
DSTM.2.150.050.050	1,5	0,5	3,0	7,5	1,45	4	50	2	40°	20°	2,5	▲
DSTM.2.150.050.070	1,5	0,5	3,0	10,5	1,45	4	50	2	40°	20°	2,5	▲

- ▲ ab Lager / on stock Δ 4 Wochen / 4 weeks x auf Anfrage / upon request
- empfohlen / recommended
- o bedingt einsetzbar / alternative recommendation
- nicht geeignet / not suitable
- unbeschichtete HM-Sorten / uncoated grades
- beschichtete HM-Sorten / coated grades
- bestückt/Cermet / brazed/Cermet

P	•
M	◦
K	◦
N	-
S	◦
H	◦



Abmessungen in mm
Dimensions in mm



HM-Sorten
Carbide grades

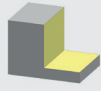

Schnittdaten DSTM Ø 1,2 - 1,5 mm

Cutting Data DSTM Ø 1,2 - 1,5 mm

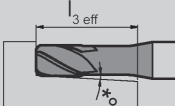

	 $vc = m/min$	 $vc = m/min$
P1.1	160	190
P1.2	160	190
P1.3	150	180
P2.1	140	170
P2.2	140	170
P2.3	140	170
P3.1	120	140
P3.2	110	130
M1.1	90	110
M2.1	80	100
M3.1	60	70

	 $vc = m/min$	 $vc = m/min$
K1.1	140	170
K1.2	130	160
K2.1	120	140
K2.2	100	120
K3.1	80	100
K3.2	70	80
S1	70	80
S2	55	70
S3	40	50
-	-	-
-	-	-

d_1	 α	 $l_{3\text{eff}}$										
		0°	0,5°	1°	2°	3°	f_z	a_e	a_p	f_z	a_e	a_p
1,2	5°	3,6	3,7	3,9	4,4	5,1	0,011	0,12	0,24	0,015	0,06	0,12
1,2	5°	6,0	6,1	6,3	6,6	7	0,010	0,12	0,18	0,013	0,06	0,10
1,2	3°	8,4	8,6	8,8	9,2	10	0,008	0,12	0,12	0,012	0,06	0,07
1,2	5°	3,6	3,7	3,9	4,4	5	0,011	0,12	0,24	0,015	0,06	0,12
1,2	5°	6,0	6,1	6,3	6,6	6,9	0,010	0,12	0,18	0,013	0,06	0,10
1,2	3°	8,4	8,6	8,8	9,2	10	0,008	0,12	0,12	0,012	0,06	0,07
1,2	5°	3,6	3,7	3,9	4,4	5	0,011	0,12	0,24	0,015	0,06	0,12
1,2	5°	6,0	6,1	6,2	6,6	6,9	0,010	0,12	0,18	0,013	0,06	0,10
1,2	3°	8,4	8,5	8,8	9,2	10	0,008	0,12	0,12	0,012	0,06	0,07
1,5	5°	4,5	4,7	4,9	5,5	6,3	0,012	0,15	0,30	0,018	0,08	0,15
1,5	5°	7,5	7,6	7,8	8,2	8,7	0,011	0,15	0,23	0,016	0,08	0,12
1,5	3°	10,5	10,7	11	11,6	12,6	0,010	0,15	0,15	0,014	0,08	0,09
1,5	5°	4,5	4,7	4,9	5,5	6,3	0,012	0,15	0,30	0,018	0,08	0,15
1,5	5°	7,5	7,6	7,8	8,2	8,7	0,011	0,15	0,23	0,016	0,08	0,12
1,5	3°	10,5	10,7	11	11,6	12,6	0,010	0,15	0,15	0,014	0,08	0,09
1,5	5°	4,5	4,7	4,9	5,5	6,3	0,012	0,15	0,30	0,018	0,08	0,15
1,5	5°	7,5	7,6	7,8	8,2	8,7	0,011	0,15	0,23	0,016	0,08	0,12
1,5	3°	10,5	10,7	11	11,5	12,5	0,010	0,15	0,15	0,014	0,08	0,09
1,5	5°	4,5	4,7	4,9	5,4	6,2	0,012	0,15	0,30	0,018	0,08	0,15
1,5	5°	7,5	7,6	7,8	8,2	8,6	0,011	0,15	0,23	0,016	0,08	0,12
1,5	3°	10,5	10,7	11	11,5	12,4	0,010	0,15	0,15	0,014	0,08	0,09

Abmessungen in mm
Dimensions in mm

B

Mikrofräser Torus

Micro End Mill Torus



DSTM

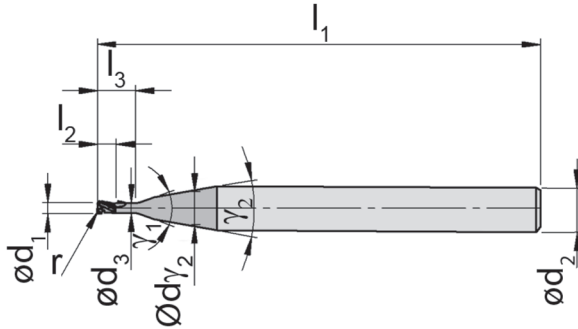
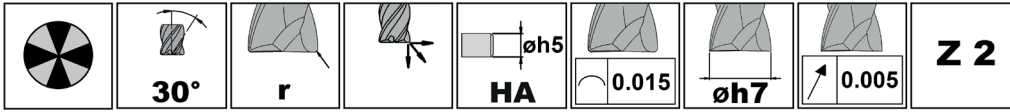

Bestellnummer Part number	d ₁	r	l ₂	l ₃	d ₃	d ₂	l ₁	Z	γ ₁	γ ₂	d _{v2}	TS3K
DSTM.2.200.000.030	2,0	0	4	6,0	1,9	4	50	2	20°	-	-	▲
DSTM.2.200.000.050	2,0	0	4	10,0	1,9	4	50	2	40°	20°	3,0	▲
DSTM.2.200.000.070	2,0	0	4	14,0	1,9	4	50	2	40°	20°	3,0	▲
DSTM.2.200.010.030	2,0	0,1	4	6,0	1,9	4	50	2	20°	-	-	▲
DSTM.2.200.010.050	2,0	0,1	4	10,0	1,9	4	50	2	40°	20°	3,0	▲
DSTM.2.200.010.070	2,0	0,1	4	14,0	1,9	4	50	2	40°	20°	3,0	▲
DSTM.2.200.020.030	2,0	0,2	4	6,0	1,9	4	50	2	20°	-	-	▲
DSTM.2.200.020.050	2,0	0,2	4	10,0	1,9	4	50	2	40°	20°	3,0	▲
DSTM.2.200.020.070	2,0	0,2	4	14,0	1,9	4	50	2	40°	20°	3,0	▲
DSTM.2.200.050.030	2,0	0,5	4	6,0	1,9	4	50	2	20°	-	-	▲
DSTM.2.200.050.050	2,0	0,5	4	10,0	1,9	4	50	2	40°	20°	3,0	▲
DSTM.2.200.050.070	2,0	0,5	4	14,0	1,9	4	50	2	40°	20°	3,0	▲
DSTM.2.250.000.030	2,5	0	5	7,5	2,4	4	50	2	20°	-	-	▲
DSTM.2.250.000.050	2,5	0	5	12,5	2,4	4	50	2	40°	20°	3,5	▲
DSTM.2.250.000.070	2,5	0	5	17,5	2,4	4	60	2	40°	20°	3,5	▲
DSTM.2.250.010.030	2,5	0,1	5	7,5	2,4	4	50	2	20°	-	-	▲
DSTM.2.250.010.050	2,5	0,1	5	12,5	2,4	4	50	2	40°	20°	3,5	▲
DSTM.2.250.010.070	2,5	0,1	5	17,5	2,4	4	60	2	40°	20°	3,5	▲
DSTM.2.250.020.030	2,5	0,2	5	7,5	2,4	4	50	2	20°	-	-	▲
DSTM.2.250.020.050	2,5	0,2	5	12,5	2,4	4	50	2	40°	20°	3,5	▲
DSTM.2.250.020.070	2,5	0,2	5	17,5	2,4	4	60	2	40°	20°	3,5	▲
DSTM.2.250.050.030	2,5	0,5	5	7,5	2,4	4	50	2	20°	-	-	▲
DSTM.2.250.050.050	2,5	0,5	5	12,5	2,4	4	50	2	40°	20°	3,5	▲
DSTM.2.250.050.070	2,5	0,5	5	17,5	2,4	4	60	2	40°	20°	3,5	▲

▲ ab Lager / on stock Δ 4 Wochen / 4 weeks x auf Anfrage / upon request

● empfohlen / recommended

o bedingt einsetzbar / alternative recommendation

- nicht geeignet / not suitable

■ unbeschichtete HM-Sorten / uncoated grades

■ beschichtete HM-Sorten / coated grades

■ bestückt/Cermet / brazed/Cermet

Abmessungen in mm

Dimensions in mm



P	●
M	○
K	○
N	-
S	○
H	○



HM-Sorten
Carbide grades

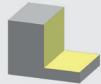

Schnittdaten DSTM Ø 2,0 - 2,5 mm

Cutting Data DSTM Ø 2,0 - 2,5 mm

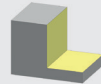

	 $vc = m/min$	 $vc = m/min$
P1.1	160	190
P1.2	160	190
P1.3	150	180
P2.1	140	170
P2.2	140	170
P2.3	140	170
P3.1	120	140
P3.2	110	130
M1.1	90	110
M2.1	80	100
M3.1	60	70

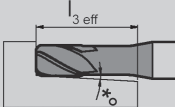
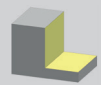
	 $vc = m/min$	 $vc = m/min$
K1.1	140	170
K1.2	130	160
K2.1	120	140
K2.2	100	120
K3.1	80	100
K3.2	70	80
S1	70	80
S2	55	70
S3	40	50
-	-	-
-	-	-

d_1	 α	 $l_{3\text{eff}}$										
		0°	0,5°	1°	2°	3°	f_z	a_e	a_p	f_z	a_e	a_p
2,0	5°	6,0	6,3	6,6	7,4	8,5	0,016	0,20	0,40	0,022	0,10	0,20
2,0	5°	10,0	10,2	10,5	11	11,9	0,014	0,20	0,30	0,020	0,10	0,16
2,0	3°	14,0	14,3	14,7	15,4	17,6	0,013	0,20	0,20	0,018	0,10	0,12
2,0	5°	6,0	6,3	6,6	7,4	8,5	0,016	0,20	0,40	0,022	0,10	0,20
2,0	5°	10,0	10,2	10,5	11	11,9	0,014	0,20	0,30	0,020	0,10	0,16
2,0	3°	14,0	14,3	14,7	15,4	17,6	0,013	0,20	0,20	0,018	0,10	0,12
2,0	5°	6,0	6,3	6,6	7,4	8,4	0,016	0,20	0,40	0,022	0,10	0,20
2,0	5°	10,0	10,2	10,4	11	11,8	0,014	0,20	0,30	0,020	0,10	0,16
2,0	3°	14,0	14,3	14,7	15,4	17,5	0,013	0,20	0,20	0,018	0,10	0,12
2,0	5°	6,0	6,2	6,6	7,3	8,3	0,016	0,20	0,40	0,022	0,10	0,20
2,0	5°	10,0	11,7	11	10,4	10,2	0,014	0,20	0,30	0,020	0,10	0,16
2,0	3°	14,0	14,3	14,6	15,4	17,4	0,013	0,20	0,20	0,018	0,10	0,12
2,5	5°	7,5	7,8	8,3	9,3	10,6	0,019	0,25	0,50	0,027	0,13	0,25
2,5	5°	12,5	12,8	13,1	13,8	∞	0,017	0,25	0,38	0,024	0,13	0,20
2,5	3°	17,5	17,9	18,3	19,8	∞	0,015	0,25	0,25	0,021	0,13	0,15
2,5	5°	7,5	7,8	8,3	9,3	10,6	0,019	0,25	0,50	0,027	0,13	0,25
2,5	5°	12,5	12,8	13,1	13,8	∞	0,017	0,25	0,38	0,024	0,13	0,20
2,5	3°	17,5	17,9	18,3	19,8	∞	0,015	0,25	0,25	0,021	0,13	0,15
2,5	5°	7,5	7,8	8,3	9,3	10,5	0,019	0,25	0,50	0,027	0,13	0,25
2,5	5°	12,5	12,8	13,1	13,8	∞	0,017	0,25	0,38	0,024	0,13	0,20
2,5	3°	17,5	17,9	18,3	19,7	∞	0,015	0,25	0,25	0,021	0,13	0,15
2,5	5°	7,5	7,8	8,2	9,2	10,4	0,019	0,25	0,50	0,027	0,13	0,25
2,5	5°	12,5	12,7	13,1	13,7	∞	0,017	0,25	0,38	0,024	0,13	0,20
2,5	3°	17,5	17,9	18,3	19,7	∞	0,015	0,25	0,25	0,021	0,13	0,15

Abmessungen in mm
Dimensions in mm

B

Mikrofräser Torus

Micro End Mill Torus



DSTM

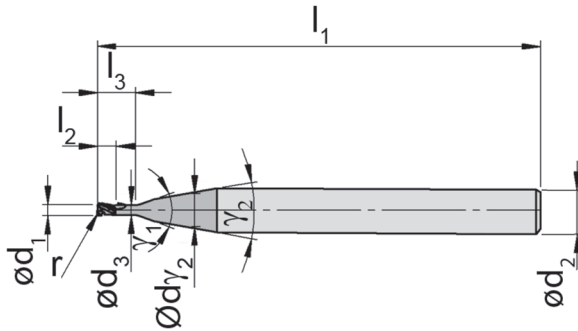
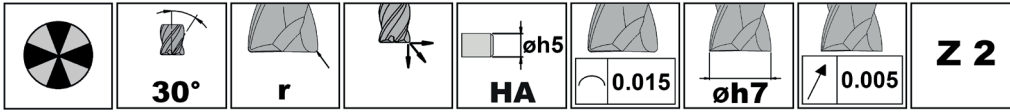

Bis Ø 3 mm vormontiert lieferbar für Toodle Schnelllaufspindel
Pre-assembled available up to Ø 3 mm for Toodle high-speed spindle

Bestellnummer Part number	d ₁	r	l ₂	l ₃	d ₃	d ₂	l ₁	Z	γ ₁	γ ₂	d _{v2}	TS3K
DSTM.2.300.000.030	3	0	6	9	2,9	4	50	2	20°	-	-	▲
DSTM.2.300.000.050	3	0	6	15	2,9	4	50	2	40°	20°	3,5	▲
DSTM.2.300.000.070	3	0	6	21	2,9	4	60	2	40°	20°	3,5	▲
DSTM.2.300.010.030	3	0,1	6	9	2,9	4	50	2	20°	-	-	▲
DSTM.2.300.010.050	3	0,1	6	15	2,9	4	50	2	40°	20°	3,5	▲
DSTM.2.300.010.070	3	0,1	6	21	2,9	4	60	2	40°	20°	3,5	▲
DSTM.2.300.020.030	3	0,2	6	9	2,9	4	50	2	20°	-	-	▲
DSTM.2.300.020.050	3	0,2	6	15	2,9	4	50	2	40°	20°	3,5	▲
DSTM.2.300.020.070	3	0,2	6	21	2,9	4	60	2	40°	20°	3,5	▲
DSTM.2.300.050.030	3	0,5	6	9	2,9	4	50	2	20°	-	-	▲
DSTM.2.300.050.050	3	0,5	6	15	2,9	4	50	2	40°	20°	3,5	▲
DSTM.2.300.050.070	3	0,5	6	21	2,9	4	60	2	40°	20°	3,5	▲
DSTM.2.300.100.030	3	1,0	6	9	2,9	4	50	2	20°	-	-	▲
DSTM.2.300.100.050	3	1,0	6	15	2,9	4	50	2	40°	20°	3,5	▲
DSTM.2.300.100.070	3	1,0	6	21	2,9	4	60	2	40°	20°	3,5	▲

▲ ab Lager / on stock Δ 4 Wochen / 4 weeks x auf Anfrage / upon request

● empfohlen / recommended

o bedingt einsetzbar / alternative recommendation

- nicht geeignet / not suitable

■ unbeschichtete HM-Sorten / uncoated grades

■ beschichtete HM-Sorten / coated grades

■ bestückt/Cermet / brazed/Cermet

Abmessungen in mm

Dimensions in mm



P	●
M	○
K	○
N	-
S	○
H	○



HM-Sorten
Carbide grades

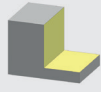

Schnittdaten DSTM Ø 3,0 mm

Cutting Data DSTM Ø 3,0 mm

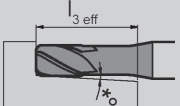
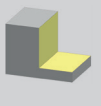

	 $vc = m/min$	 $vc = m/min$
P1.1	160	190
P1.2	160	190
P1.3	150	180
P2.1	140	170
P2.2	140	170
P2.3	140	170
P3.1	120	140
P3.2	110	130
M1.1	90	110
M2.1	80	100
M3.1	60	70

	 $vc = m/min$	 $vc = m/min$
K1.1	140	170
K1.2	130	160
K2.1	120	140
K2.2	100	120
K3.1	80	100
K3.2	70	80
S1	70	80
S2	55	70
S3	40	50
-	-	-
-	-	-

d_1	 α	 $l_{3\text{eff}}$										
		0°	0,5°	1°	2°	3°	f_z	a_e	a_p	f_z	a_e	a_p
3	5°	9,0	9,4	9,9	11,2	12,7	0,022	0,30	0,60	0,031	0,15	0,30
3	5°	15,0	15,3	15,7	∞	∞	0,020	0,30	0,45	0,028	0,15	0,24
3	3°	21,0	21,5	22,3	∞	∞	0,018	0,30	0,30	0,025	0,15	0,18
3	5°	9,0	9,4	9,9	11,2	12,7	0,022	0,30	0,60	0,031	0,15	0,30
3	5°	15,0	15,3	15,7	∞	∞	0,020	0,30	0,45	0,028	0,15	0,24
3	3°	21,0	21,5	22,3	∞	∞	0,018	0,30	0,30	0,025	0,15	0,18
3	5°	9,0	9,4	9,9	11,1	∞	0,022	0,30	0,60	0,031	0,15	0,30
3	5°	15,0	15,3	15,7	∞	∞	0,020	0,30	0,45	0,028	0,15	0,24
3	3°	21,0	21,5	22,3	∞	∞	0,018	0,30	0,30	0,025	0,15	0,18
3	5°	9,0	9,4	9,9	11,1	∞	0,022	0,30	0,60	0,031	0,15	0,30
3	5°	15,0	15,3	15,7	∞	∞	0,020	0,30	0,45	0,028	0,15	0,24
3	3°	21,0	21,5	22,2	∞	∞	0,018	0,30	0,30	0,025	0,15	0,18
3	5°	9,0	9,4	9,8	10,9	∞	0,022	0,30	0,60	0,031	0,15	0,30
3	5°	15,0	15,3	15,7	∞	∞	0,020	0,30	0,45	0,028	0,15	0,24
3	3°	21,0	21,4	22,2	∞	∞	0,018	0,30	0,30	0,025	0,15	0,18

Abmessungen in mm
Dimensions in mm

B

DSTM

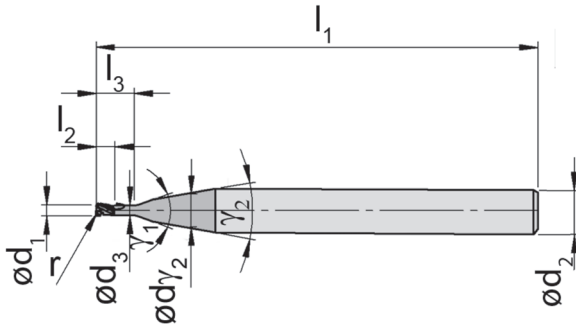
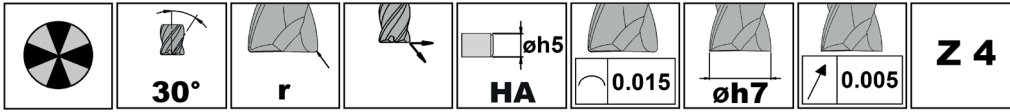

Bestellnummer Part number	d ₁	r	l ₂	l ₃	d ₃	d ₂	l ₁	Z	γ1	γ2	d _{v2}	TS3K
DSTM.4.020.000.030	0,2	0	0,4	0,6	0,18	4	50	4	20°	-	-	▲
DSTM.4.020.000.050	0,2	0	0,4	1,0	0,18	4	50	4	40°	20°	1,5	▲
DSTM.4.020.000.070	0,2	0	0,4	1,4	0,18	4	50	4	40°	20°	1,5	▲
DSTM.4.030.000.030	0,3	0	0,6	0,9	0,28	4	50	4	20°	-	-	▲
DSTM.4.030.000.050	0,3	0	0,6	1,5	0,28	4	50	4	40°	20°	1,5	▲
DSTM.4.030.000.070	0,3	0	0,6	2,1	0,28	4	50	4	40°	20°	1,5	▲
DSTM.4.040.000.030	0,4	0	0,7	1,2	0,38	4	50	4	20°	-	-	▲
DSTM.4.040.000.050	0,4	0	0,7	2,0	0,38	4	50	4	40°	20°	1,5	▲
DSTM.4.040.000.070	0,4	0	0,7	2,8	0,38	4	50	4	40°	20°	1,5	▲
DSTM.4.050.000.030	0,5	0	1,0	1,5	0,47	4	50	4	20°	-	-	▲
DSTM.4.050.000.050	0,5	0	1,0	2,5	0,47	4	50	4	40°	20°	1,5	▲
DSTM.4.050.000.070	0,5	0	1,0	3,5	0,47	4	50	4	40°	20°	1,5	▲
DSTM.4.050.010.030	0,5	0,1	1,0	1,5	0,47	4	50	4	20°	-	-	▲
DSTM.4.050.010.050	0,5	0,1	1,0	2,5	0,47	4	50	4	40°	20°	1,5	▲
DSTM.4.050.010.070	0,5	0,1	1,0	3,5	0,47	4	50	4	40°	20°	1,5	▲
DSTM.4.060.000.030	0,6	0	1,2	1,8	0,60	4	50	4	20°	-	-	▲
DSTM.4.060.000.050	0,6	0	1,2	3,0	0,55	4	50	4	40°	20°	1,5	▲
DSTM.4.060.000.070	0,6	0	1,2	4,2	0,55	4	50	4	40°	20°	1,5	▲
DSTM.4.060.010.030	0,6	0,1	1,2	1,8	0,55	4	50	4	20°	-	-	▲
DSTM.4.060.010.050	0,6	0,1	1,2	3,0	0,55	4	50	4	40°	20°	1,5	▲
DSTM.4.060.010.070	0,6	0,1	1,2	4,2	0,55	4	50	4	40°	20°	1,5	▲

▲ ab Lager / on stock Δ 4 Wochen / 4 weeks x auf Anfrage / upon request

● empfohlen / recommended

o bedingt einsetzbar / alternative recommendation

- nicht geeignet / not suitable

■ unbeschichtete HM-Sorten / uncoated grades

■ beschichtete HM-Sorten / coated grades

■ bestückt/Cermet / brazed/Cermet

Abmessungen in mm

Dimensions in mm



P	●
M	○
K	○
N	-
S	○
H	○



HM-Sorten
Carbide grades

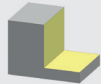

Schnittdaten DSTM Ø 0,2 - 0,6 mm

Cutting Data DSTM Ø 0,2 - 0,6 mm

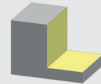

	 vc = m/min	 vc = m/min
P1.1	160	190
P1.2	160	190
P1.3	150	180
P2.1	140	170
P2.2	140	170
P2.3	140	170
P3.1	120	140
P3.2	110	130
M1.1	90	110
M2.1	80	100
M3.1	60	70

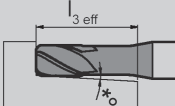
	 vc = m/min	 vc = m/min
K1.1	140	170
K1.2	130	160
K2.1	120	140
K2.2	100	120
K3.1	80	100
K3.2	70	80
S1	70	80
S2	55	70
S3	40	50
-	-	-
-	-	-

d ₁												
		0°	0,5°	1°	2°	3°	f _z	a _e	a _p	f _z	a _e	a _p
0,2	4°	0,6	0,6	0,6	0,7	0,8	0,004	0,02	0,04	0,006	0,01	0,02
0,2	4°	1,0	1	1	1,1	1,1	0,004	0,02	0,03	0,005	0,01	0,02
0,2	3°	1,4	1,4	1,4	1,5	1,6	0,003	0,02	0,02	0,004	0,01	0,01
0,3	4°	0,9	0,9	0,9	1,1	1,2	0,005	0,03	0,06	0,006	0,02	0,03
0,3	4°	1,5	1,5	1,5	1,6	1,7	0,004	0,03	0,05	0,006	0,02	0,02
0,3	3°	2,1	2,1	2,2	2,3	2,4	0,004	0,03	0,03	0,005	0,02	0,02
0,4	4°	1,2	1,2	1,2	1,4	1,5	0,005	0,04	0,08	0,007	0,02	0,04
0,4	4°	2,0	2	2	2,1	2,2	0,005	0,04	0,06	0,007	0,02	0,03
0,4	3°	2,8	2,8	2,9	3	3,1	0,004	0,04	0,04	0,006	0,02	0,02
0,5	4°	1,5	1,5	1,6	1,8	2,1	0,006	0,05	0,10	0,008	0,03	0,05
0,5	4°	2,5	2,5	2,6	2,7	2,9	0,005	0,05	0,08	0,007	0,03	0,04
0,5	3°	3,5	3,5	3,6	3,8	4	0,005	0,05	0,05	0,007	0,03	0,03
0,5	4°	1,5	1,5	1,6	1,8	2	0,006	0,05	0,10	0,008	0,03	0,05
0,5	4°	2,5	2,5	2,6	2,7	2,9	0,005	0,05	0,08	0,007	0,03	0,04
0,5	3°	3,5	3,5	3,6	3,8	4	0,005	0,05	0,05	0,007	0,03	0,03
0,6	4°	1,8	1,8	1,9	2,2	2,5	0,006	0,06	0,12	0,009	0,03	0,06
0,6	4°	3,0	3	3,1	3,3	3,5	0,006	0,06	0,09	0,008	0,03	0,05
0,6	3°	4,2	4,2	4,4	4,6	4,9	0,005	0,06	0,06	0,007	0,03	0,04
0,6	4°	1,8	1,8	1,9	2,2	2,5	0,006	0,06	0,12	0,009	0,03	0,06
0,6	4°	3,0	3	3,1	3,3	3,4	0,006	0,06	0,09	0,008	0,03	0,05
0,6	3°	4,2	4,2	4,4	4,6	4,8	0,005	0,06	0,06	0,007	0,03	0,04

Abmessungen in mm
Dimensions in mm

B

DSTM

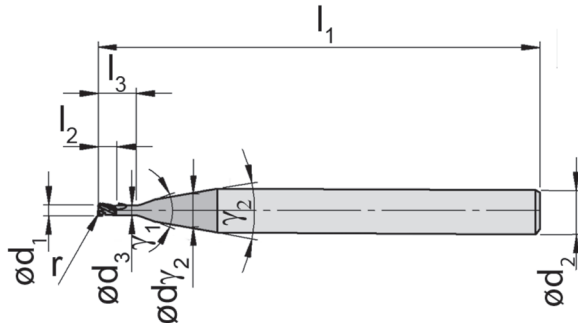
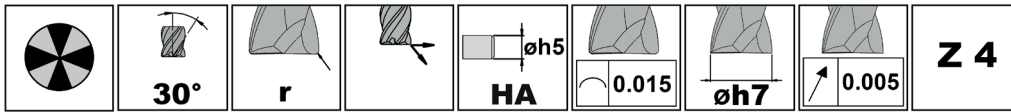

Bestellnummer Part number	d ₁	r	l ₂	l ₃	d ₃	d ₂	l ₁	Z	γ ₁	γ ₂	d _{y2}	TS3K
DSTM.4.070.000.030	0,7	0	1,4	2,1	0,65	4	50	4	20°	-	-	▲
DSTM.4.070.000.050	0,7	0	1,4	3,5	0,65	4	50	4	40°	20°	1,5	▲
DSTM.4.070.000.070	0,7	0	1,4	4,9	0,65	4	50	4	40°	20°	1,5	▲
DSTM.4.070.010.030	0,7	0,1	1,4	2,1	0,65	4	50	4	20°	-	-	▲
DSTM.4.070.010.050	0,7	0,1	1,4	3,5	0,65	4	50	4	40°	20°	1,5	▲
DSTM.4.070.010.070	0,7	0,1	1,4	4,9	0,65	4	50	4	40°	20°	1,5	▲
DSTM.4.080.000.030	0,8	0	1,6	2,4	0,75	4	50	4	20°	-	-	▲
DSTM.4.080.000.050	0,8	0	1,6	4,0	0,75	4	50	4	40°	20°	1,5	▲
DSTM.4.080.000.070	0,8	0	1,6	5,6	0,75	4	50	4	40°	20°	1,5	▲
DSTM.4.080.010.030	0,8	0,1	1,6	2,4	0,75	4	50	4	20°	-	-	▲
DSTM.4.080.010.050	0,8	0,1	1,6	4,0	0,75	4	50	4	40°	20°	1,5	▲
DSTM.4.080.010.070	0,8	0,1	1,6	5,6	0,75	4	50	4	40°	20°	1,5	▲
DSTM.4.090.000.030	0,9	0	1,8	2,7	0,85	4	50	4	20°	-	-	▲
DSTM.4.090.000.050	0,9	0	1,8	4,5	0,85	4	50	4	40°	20°	1,5	▲
DSTM.4.090.000.070	0,9	0	1,8	6,3	0,85	4	50	4	40°	20°	1,5	▲
DSTM.4.090.010.030	0,9	0,1	1,8	2,7	0,85	4	50	4	20°	-	-	▲
DSTM.4.090.010.050	0,9	0,1	1,8	4,5	0,85	4	50	4	40°	20°	1,5	▲
DSTM.4.090.010.070	0,9	0,1	1,8	6,3	0,85	4	50	4	40°	20°	1,5	▲
DSTM.4.100.000.030	1,0	0	2,0	3,0	0,95	4	50	4	20°	-	-	▲
DSTM.4.100.000.050	1,0	0	2,0	5,0	0,95	4	50	4	40°	20°	2,0	▲
DSTM.4.100.000.070	1,0	0	2,0	7,0	0,95	4	50	4	40°	20°	2,0	▲
DSTM.4.100.010.030	1,0	0,1	2,0	3,0	0,95	4	50	4	20°	-	-	▲
DSTM.4.100.010.050	1,0	0,1	2,0	5,0	0,95	4	50	4	40°	20°	2,0	▲
DSTM.4.100.010.070	1,0	0,1	2,0	7,0	0,95	4	50	4	40°	20°	2,0	▲
DSTM.4.100.020.030	1,0	0,2	2,0	3,0	0,95	4	50	4	20°	-	-	▲
DSTM.4.100.020.050	1,0	0,2	2,0	5,0	0,95	4	50	4	40°	20°	2,0	▲
DSTM.4.100.020.070	1,0	0,2	2,0	7,0	0,95	4	50	4	40°	20°	2,0	▲

▲ ab Lager / on stock Δ 4 Wochen / 4 weeks x auf Anfrage / upon request

● empfohlen / recommended

○ bedingt einsetzbar / alternative recommendation

- nicht geeignet / not suitable

■ unbeschichtete HM-Sorten / uncoated grades

■ beschichtete HM-Sorten / coated grades



■ bestückt/Cermet / brazed/Cermet



P	●
M	○
K	○
N	-
S	○
H	○

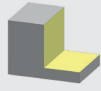

Schnittdaten DSTM Ø 0,7 - 1,0 mm

Cutting Data DSTM Ø 0,7 - 1,0 mm

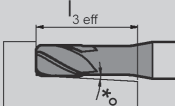
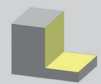

	 vc = m/min	 vc = m/min
P1.1	160	190
P1.2	160	190
P1.3	150	180
P2.1	140	170
P2.2	140	170
P2.3	140	170
P3.1	120	140
P3.2	110	130
M1.1	90	110
M2.1	80	100
M3.1	60	70

	 vc = m/min	 vc = m/min
K1.1	140	170
K1.2	130	160
K2.1	120	140
K2.2	100	120
K3.1	80	100
K3.2	70	80
S1	70	80
S2	55	70
S3	40	50
-	-	-
-	-	-

d ₁	 α											
		0°	0,5°	1°	2°	3°	f _z	a _e	a _p	f _z	a _e	a _p
0,7	4°	2,1	2,1	2,2	2,5	2,8	0,007	0,07	0,14	0,010	0,04	0,07
0,7	4°	3,5	3,5	3,6	3,8	3,9	0,006	0,07	0,11	0,009	0,04	0,06
0,7	3°	4,9	4,9	5,1	5,3	5,5	0,006	0,07	0,07	0,008	0,04	0,04
0,7	4°	2,1	2,1	2,2	2,5	2,8	0,007	0,07	0,14	0,010	0,04	0,07
0,7	4°	3,5	3,5	3,6	3,8	3,9	0,006	0,07	0,11	0,009	0,04	0,06
0,7	3°	4,9	4,9	5,1	5,3	5,5	0,006	0,07	0,07	0,008	0,04	0,04
0,8	4°	2,4	2,5	2,6	2,9	3,3	0,008	0,08	0,16	0,011	0,04	0,08
0,8	4°	4,0	4	4,2	4,4	4,6	0,007	0,08	0,12	0,010	0,04	0,06
0,8	3°	5,6	5,7	5,8	6,1	6,5	0,006	0,08	0,08	0,009	0,04	0,05
0,8	4°	2,4	2,5	2,6	2,9	3,3	0,008	0,08	0,16	0,011	0,04	0,08
0,8	4°	4,0	4	4,2	4,4	4,6	0,007	0,08	0,12	0,010	0,04	0,06
0,8	3°	5,6	5,7	5,8	6,1	6,5	0,006	0,08	0,08	0,009	0,04	0,05
0,9	4°	2,7	2,8	2,9	3,2	3,6	0,008	0,09	0,18	0,012	0,05	0,09
0,9	4°	4,5	4,5	4,7	4,9	5,1	0,008	0,09	0,14	0,011	0,05	0,07
0,9	3°	6,3	6,4	6,5	6,8	7,2	0,007	0,09	0,09	0,009	0,05	0,05
0,9	4°	2,7	2,8	2,9	3,2	3,6	0,008	0,09	0,18	0,012	0,05	0,09
0,9	4°	4,5	4,5	4,7	4,9	5,1	0,008	0,09	0,14	0,011	0,05	0,07
0,9	3°	6,3	6,4	6,5	6,8	7,2	0,007	0,09	0,09	0,009	0,05	0,05
1,0	4°	3,0	3,1	3,3	3,7	4,2	0,009	0,10	0,20	0,013	0,05	0,10
1,0	4°	5,0	5,1	5,2	5,5	5,8	0,008	0,10	0,15	0,011	0,05	0,08
1,0	3°	7,0	7,1	7,3	7,7	8,1	0,007	0,10	0,10	0,010	0,05	0,06
1,0	4°	3,0	3,1	3,3	3,7	4,2	0,009	0,10	0,20	0,013	0,05	0,10
1,0	4°	5,0	5,1	5,2	5,5	5,8	0,008	0,10	0,15	0,011	0,05	0,08
1,0	3°	7,0	7,1	7,3	7,7	8,1	0,007	0,10	0,10	0,010	0,05	0,06
1,0	4°	3,0	3,1	3,3	3,7	4,2	0,009	0,10	0,20	0,013	0,05	0,10
1,0	4°	5,0	5,1	5,2	5,5	5,8	0,008	0,10	0,15	0,011	0,05	0,08
1,0	3°	7,0	7,1	7,3	7,7	8,1	0,007	0,10	0,10	0,010	0,05	0,06

Abmessungen in mm
Dimensions in mm

B

DSTM

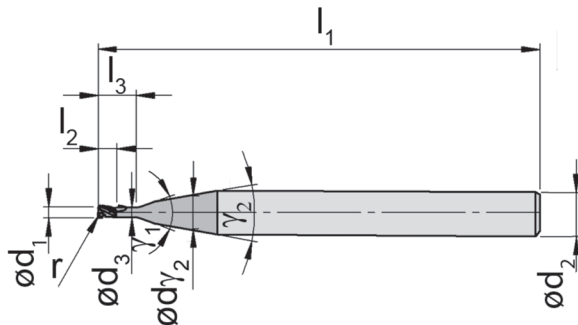
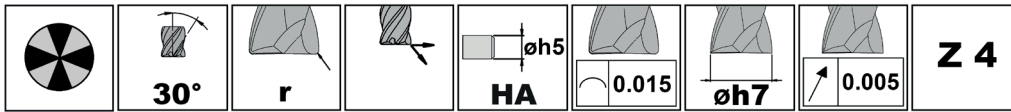

Bestellnummer Part number	d ₁	r	l ₂	l ₃	d ₃	d ₂	l ₁	Z	γ1	γ2	d _{v2}	TS3K
DSTM.4.120.000.030	1,2	0	2,4	3,6	1,15	4	50	4	20°	-	-	▲
DSTM.4.120.000.050	1,2	0	2,4	6,0	1,15	4	50	4	40°	20°	2,0	▲
DSTM.4.120.000.070	1,2	0	2,4	8,4	1,15	4	50	4	40°	20°	2,0	▲
DSTM.4.120.010.030	1,2	0,1	2,4	3,6	1,15	4	50	4	20°	-	-	▲
DSTM.4.120.010.050	1,2	0,1	2,4	6,0	1,15	4	50	4	40°	20°	2,0	▲
DSTM.4.120.010.070	1,2	0,1	2,4	8,4	1,15	4	50	4	40°	20°	2,0	▲
DSTM.4.120.020.030	1,2	0,2	2,4	3,6	1,15	4	50	4	20°	-	-	▲
DSTM.4.120.020.050	1,2	0,2	2,4	6,0	1,15	4	50	4	40°	20°	2,0	▲
DSTM.4.120.020.070	1,2	0,2	2,4	8,4	1,15	4	50	4	40°	20°	2,0	▲
DSTM.4.150.000.030	1,5	0	3,0	4,5	1,45	4	50	4	20°	-	-	▲
DSTM.4.150.000.050	1,5	0	3,0	7,5	1,45	4	50	4	40°	20°	2,5	▲
DSTM.4.150.000.070	1,5	0	3,0	10,5	1,45	4	50	4	40°	20°	2,5	▲
DSTM.4.150.010.030	1,5	0,1	3,0	4,5	1,45	4	50	4	20°	-	-	▲
DSTM.4.150.010.050	1,5	0,1	3,0	7,5	1,45	4	50	4	40°	20°	2,5	▲
DSTM.4.150.010.070	1,5	0,1	3,0	10,5	1,45	4	50	4	40°	20°	2,5	▲
DSTM.4.150.020.030	1,5	0,2	3,0	4,5	1,45	4	50	4	20°	-	-	▲
DSTM.4.150.020.050	1,5	0,2	3,0	7,5	1,45	4	50	4	40°	20°	2,5	▲
DSTM.4.150.020.070	1,5	0,2	3,0	10,5	1,45	4	50	4	40°	20°	2,5	▲
DSTM.4.150.050.030	1,5	0,5	3,0	4,5	1,45	4	50	4	20°	-	-	▲
DSTM.4.150.050.050	1,5	0,5	3,0	7,5	1,45	4	50	4	40°	20°	2,5	▲
DSTM.4.150.050.070	1,5	0,5	3,0	10,5	1,45	4	50	4	40°	20°	2,5	▲

▲ ab Lager / on stock Δ 4 Wochen / 4 weeks x auf Anfrage / upon request

● empfohlen / recommended

o bedingt einsetzbar / alternative recommendation

- nicht geeignet / not suitable

■ unbeschichtete HM-Sorten / uncoated grades

■ beschichtete HM-Sorten / coated grades

■ bestückt/Cermet / brazed/Cermet

Abmessungen in mm

Dimensions in mm



P	•
M	○
K	○
N	-
S	○
H	○



HM-Sorten
Carbide grades

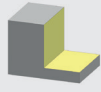

Schnittdaten DSTM Ø 1,2 - 1,5 mm

Cutting Data DSTM Ø 1,2 - 1,5 mm

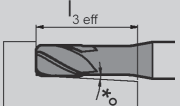
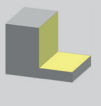

	 $vc = m/min$	 $vc = m/min$
P1.1	160	190
P1.2	160	190
P1.3	150	180
P2.1	140	170
P2.2	140	170
P2.3	140	170
P3.1	120	140
P3.2	110	130
M1.1	90	110
M2.1	80	100
M3.1	60	70

	 $vc = m/min$	 $vc = m/min$
K1.1	140	170
K1.2	130	160
K2.1	120	140
K2.2	100	120
K3.1	80	100
K3.2	70	80
S1	70	80
S2	55	70
S3	40	50
-	-	-
-	-	-

d_1	 α	 $l_{3\text{eff}}$, α_0										
		0°	0,5°	1°	2°	3°	f_z	a_e	a_p	f_z	a_e	a_p
1,2	4°	3,6	3,7	3,9	4,4	5,1	0,010	0,12	0,24	0,014	0,06	0,12
1,2	4°	6,0	6,1	6,3	6,6	7	0,009	0,12	0,18	0,013	0,06	0,10
1,2	3°	8,4	8,6	8,8	9,2	10	0,008	0,12	0,12	0,012	0,06	0,07
1,2	4°	3,6	3,7	3,9	4,4	5	0,010	0,12	0,24	0,014	0,06	0,12
1,2	4°	6,0	6,1	6,3	6,6	6,9	0,009	0,12	0,18	0,013	0,06	0,10
1,2	3°	8,4	8,6	8,8	9,2	10	0,008	0,12	0,12	0,012	0,06	0,07
1,2	4°	3,6	3,7	3,9	4,4	5	0,010	0,12	0,24	0,014	0,06	0,12
1,2	4°	6,0	6,1	6,2	6,6	6,9	0,009	0,12	0,18	0,013	0,06	0,10
1,2	3°	8,4	8,5	8,8	9,2	10	0,008	0,12	0,12	0,012	0,06	0,07
1,5	4°	4,5	4,7	4,9	5,5	6,3	0,012	0,15	0,30	0,017	0,08	0,15
1,5	4°	7,5	7,6	7,8	8,2	8,7	0,011	0,15	0,23	0,015	0,08	0,12
1,5	3°	10,5	10,7	11	11,6	12,6	0,010	0,15	0,15	0,014	0,08	0,09
1,5	4°	4,5	4,7	4,9	5,5	6,3	0,012	0,15	0,30	0,017	0,08	0,15
1,5	4°	7,5	7,6	7,8	8,2	8,7	0,011	0,15	0,23	0,015	0,08	0,12
1,5	3°	10,5	10,7	11	11,6	12,6	0,010	0,15	0,15	0,014	0,08	0,09
1,5	4°	4,5	4,7	4,9	5,5	6,3	0,012	0,15	0,30	0,017	0,08	0,15
1,5	4°	7,5	7,6	7,8	8,2	8,7	0,011	0,15	0,23	0,015	0,08	0,12
1,5	3°	10,5	10,7	11	11,5	12,5	0,010	0,15	0,15	0,014	0,08	0,09
1,5	4°	4,5	4,7	4,9	5,4	6,2	0,012	0,15	0,30	0,017	0,08	0,15
1,5	4°	7,5	7,6	7,8	8,2	8,6	0,011	0,15	0,23	0,015	0,08	0,12
1,5	3°	10,5	10,7	11	11,5	12,4	0,010	0,15	0,15	0,014	0,08	0,09

Abmessungen in mm
Dimensions in mm

B

DSTM

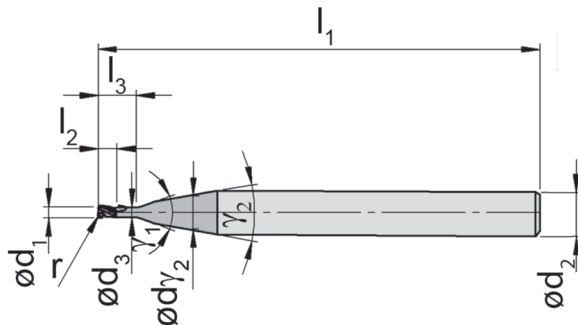
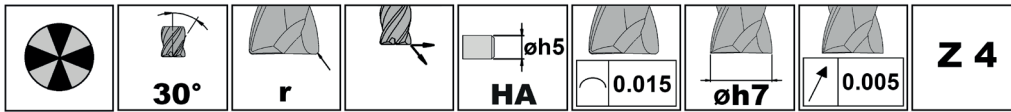

Bestellnummer Part number	d ₁	r	l ₂	l ₃	d ₃	d ₂	l ₁	Z	γ ₁	γ ₂	d _{v2}	TS3K
DSTM.4.200.000.030	2,0	0	4	6,0	1,9	4	50	4	20°	-	-	▲
DSTM.4.200.000.050	2,0	0	4	10,0	1,9	4	50	4	40°	20°	3,0	▲
DSTM.4.200.000.070	2,0	0	4	14,0	1,9	4	50	4	40°	20°	3,0	▲
DSTM.4.200.010.030	2,0	0,1	4	6,0	1,9	4	50	4	20°	-	-	▲
DSTM.4.200.010.050	2,0	0,1	4	10,0	1,9	4	50	4	40°	20°	3,0	▲
DSTM.4.200.010.070	2,0	0,1	4	14,0	1,9	4	50	4	40°	20°	3,0	▲
DSTM.4.200.020.030	2,0	0,2	4	6,0	1,9	4	50	4	20°	-	-	▲
DSTM.4.200.020.050	2,0	0,2	4	10,0	1,9	4	50	4	40°	20°	3,0	▲
DSTM.4.200.020.070	2,0	0,2	4	14,0	1,9	4	50	4	40°	20°	3,0	▲
DSTM.4.200.050.030	2,0	0,5	4	6,0	1,9	4	50	4	20°	-	-	▲
DSTM.4.200.050.050	2,0	0,5	4	10,0	1,9	4	50	4	40°	20°	3,0	▲
DSTM.4.200.050.070	2,0	0,5	4	14,0	1,9	4	50	4	40°	20°	3,0	▲
DSTM.4.250.000.030	2,5	0	5	7,5	2,4	4	50	4	20°	-	-	▲
DSTM.4.250.000.050	2,5	0	5	12,5	2,4	4	50	4	40°	20°	3,5	▲
DSTM.4.250.000.070	2,5	0	5	17,5	2,4	4	60	4	40°	20°	3,5	▲
DSTM.4.250.010.030	2,5	0,1	5	7,5	2,4	4	50	4	20°	-	-	▲
DSTM.4.250.010.050	2,5	0,1	5	12,5	2,4	4	50	4	40°	20°	3,5	▲
DSTM.4.250.010.070	2,5	0,1	5	17,5	2,4	4	60	4	40°	20°	3,5	▲
DSTM.4.250.020.030	2,5	0,2	5	7,5	2,4	4	50	4	20°	-	-	▲
DSTM.4.250.020.050	2,5	0,2	5	12,5	2,4	4	50	4	40°	20°	3,5	▲
DSTM.4.250.020.070	2,5	0,2	5	17,5	2,4	4	60	4	40°	20°	3,5	▲
DSTM.4.250.050.030	2,5	0,5	5	7,5	2,4	4	50	4	20°	-	-	▲
DSTM.4.250.050.050	2,5	0,5	5	12,5	2,4	4	50	4	40°	20°	3,5	▲
DSTM.4.250.050.070	2,5	0,5	5	17,5	2,4	4	60	4	40°	20°	3,5	▲

▲ ab Lager / on stock Δ 4 Wochen / 4 weeks x auf Anfrage / upon request

● empfohlen / recommended

o bedingt einsetzbar / alternative recommendation

- nicht geeignet / not suitable

■ unbeschichtete HM-Sorten / uncoated grades

■ beschichtete HM-Sorten / coated grades

■ bestückt/Cermet / brazed/Cermet

Abmessungen in mm

Dimensions in mm



P	●
M	○
K	○
N	-
S	○
H	○



HM-Sorten
Carbide grades

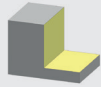

Schnittdaten DSTM Ø 2,0 - 2,5 mm

Cutting Data DSTM Ø 2,0 - 2,5 mm

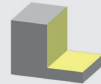

	 vc = m/min	 vc = m/min
P1.1	160	190
P1.2	160	190
P1.3	150	180
P2.1	140	170
P2.2	140	170
P2.3	140	170
P3.1	120	140
P3.2	110	130
M1.1	90	110
M2.1	80	100
M3.1	60	70

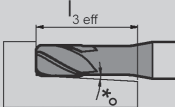
	 vc = m/min	 vc = m/min
K1.1	140	170
K1.2	130	160
K2.1	120	140
K2.2	100	120
K3.1	80	100
K3.2	70	80
S1	70	80
S2	55	70
S3	40	50
-	-	-
-	-	-

d ₁	 α											
		0°	0,5°	1°	2°	3°	f _z	a _e	a _p	f _z	a _e	a _p
2,0	4°	6,0	6,3	6,6	7,4	8,5	0,015	0,20	0,40	0,022	0,10	0,20
2,0	4°	10,0	10,2	10,5	11	11,9	0,014	0,20	0,30	0,019	0,10	0,16
2,0	3°	14,0	14,3	14,7	15,4	17,6	0,012	0,20	0,20	0,017	0,10	0,12
2,0	4°	6,0	6,3	6,6	7,4	8,5	0,015	0,20	0,40	0,022	0,10	0,20
2,0	4°	10,0	10,2	10,5	11	11,9	0,014	0,20	0,30	0,019	0,10	0,16
2,0	3°	14,0	14,3	14,7	15,4	17,6	0,012	0,20	0,20	0,017	0,10	0,12
2,0	4°	6,0	6,3	6,6	7,4	8,4	0,015	0,20	0,40	0,022	0,10	0,20
2,0	4°	10,0	10,2	10,4	11	11,8	0,014	0,20	0,30	0,019	0,10	0,16
2,0	3°	14,0	14,3	14,7	15,4	17,5	0,012	0,20	0,20	0,017	0,10	0,12
2,0	4°	6,0	6,2	6,6	7,3	8,3	0,015	0,20	0,40	0,022	0,10	0,20
2,0	4°	10,0	11,7	11	10,4	10,2	0,014	0,20	0,30	0,019	0,10	0,16
2,0	3°	14,0	14,3	14,6	15,4	17,4	0,012	0,20	0,20	0,017	0,10	0,12
2,5	4°	7,5	7,8	8,3	9,3	10,6	0,018	0,25	0,50	0,026	0,13	0,25
2,5	4°	12,5	12,8	13,1	13,8	∞	0,017	0,25	0,38	0,023	0,13	0,20
2,5	3°	17,5	17,9	18,3	19,8	∞	0,015	0,25	0,25	0,021	0,13	0,15
2,5	4°	7,5	7,8	8,3	9,3	10,6	0,018	0,25	0,50	0,026	0,13	0,25
2,5	4°	12,5	12,8	13,1	13,8	∞	0,017	0,25	0,38	0,023	0,13	0,20
2,5	3°	17,5	17,9	18,3	19,8	∞	0,015	0,25	0,25	0,021	0,13	0,15
2,5	4°	7,5	7,8	8,3	9,3	10,5	0,018	0,25	0,50	0,026	0,13	0,25
2,5	4°	12,5	12,8	13,1	13,8	∞	0,017	0,25	0,38	0,023	0,13	0,20
2,5	3°	17,5	17,9	18,3	19,7	∞	0,015	0,25	0,25	0,021	0,13	0,15
2,5	4°	7,5	7,8	8,2	9,2	10,4	0,018	0,25	0,50	0,026	0,13	0,25
2,5	4°	12,5	12,7	13,1	13,7	∞	0,017	0,25	0,38	0,023	0,13	0,20
2,5	3°	17,5	17,9	18,3	19,7	∞	0,015	0,25	0,25	0,021	0,13	0,15

Abmessungen in mm
Dimensions in mm

B

Mikrofräser Torus

Micro End Mill Torus



DSTM

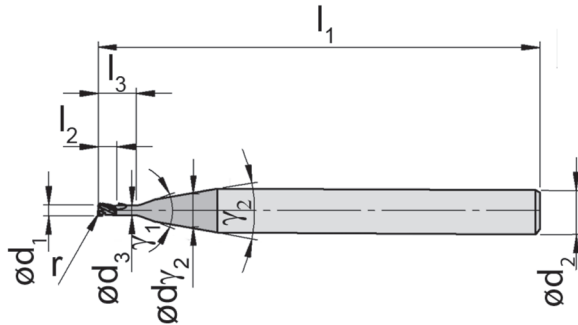
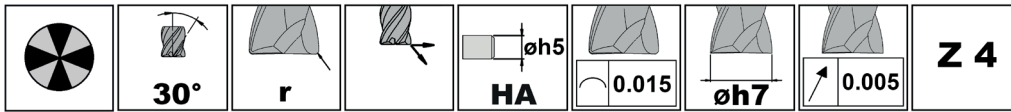

Bis Ø 3 mm vormontiert lieferbar für Toodle Schnelllaufspindel
Pre-assembled available up to Ø 3 mm for Toodle high-speed spindle

Bestellnummer Part number	d ₁	r	l ₂	l ₃	d ₃	d ₂	l ₁	Z	γ ₁	γ ₂	d _{v2}	TS3K
DSTM.4.300.000.030	3	0	6	9	2,9	4	50	4	20°	-	-	▲
DSTM.4.300.000.050	3	0	6	15	2,9	4	50	4	40°	20°	3,5	▲
DSTM.4.300.000.070	3	0	6	21	2,9	4	60	4	40°	20°	3,5	▲
DSTM.4.300.010.030	3	0,1	6	9	2,9	4	50	4	20°	-	-	▲
DSTM.4.300.010.050	3	0,1	6	15	2,9	4	50	4	40°	20°	3,5	▲
DSTM.4.300.010.070	3	0,1	6	21	2,9	4	60	4	40°	20°	3,5	▲
DSTM.4.300.020.030	3	0,2	6	9	2,9	4	50	4	20°	-	-	▲
DSTM.4.300.020.050	3	0,2	6	15	2,9	4	50	4	40°	20°	3,5	▲
DSTM.4.300.020.070	3	0,2	6	21	2,9	4	60	4	40°	20°	3,5	▲
DSTM.4.300.050.030	3	0,5	6	9	2,9	4	50	4	20°	-	-	▲
DSTM.4.300.050.050	3	0,5	6	15	2,9	4	50	4	40°	20°	3,5	▲
DSTM.4.300.050.070	3	0,5	6	21	2,9	4	60	4	40°	20°	3,5	▲
DSTM.4.300.100.030	3	1,0	6	9	2,9	4	50	4	20°	-	-	▲
DSTM.4.300.100.050	3	1,0	6	15	2,9	4	50	4	40°	20°	3,5	▲
DSTM.4.300.100.070	3	1,0	6	21	2,9	4	60	4	40°	20°	3,5	▲

▲ ab Lager / on stock Δ 4 Wochen / 4 weeks x auf Anfrage / upon request

● empfohlen / recommended

o bedingt einsetzbar / alternative recommendation

- nicht geeignet / not suitable

■ unbeschichtete HM-Sorten / uncoated grades

■ beschichtete HM-Sorten / coated grades

■ bestückt/Cermet / brazed/Cermet

Abmessungen in mm

Dimensions in mm



P	●
M	○
K	○
N	-
S	○
H	○



HM-Sorten
Carbide grades

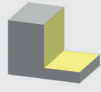

Schnittdaten DSTM Ø 3,0 mm

Cutting Data DSTM Ø 3,0 mm

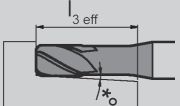
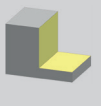

	 $vc = m/min$	 $vc = m/min$
P1.1	160	190
P1.2	160	190
P1.3	150	180
P2.1	140	170
P2.2	140	170
P2.3	140	170
P3.1	120	140
P3.2	110	130
M1.1	90	110
M2.1	80	100
M3.1	60	70

	 $vc = m/min$	 $vc = m/min$
K1.1	140	170
K1.2	130	160
K2.1	120	140
K2.2	100	120
K3.1	80	100
K3.2	70	80
S1	70	80
S2	55	70
S3	40	50
-	-	-
-	-	-

d_1	 α	 $l_{3\text{eff}}$										
		0°	0,5°	1°	2°	3°	f_z	a_e	a_p	f_z	a_e	a_p
3	4°	9,0	9,4	9,9	11,2	12,7	0,022	0,30	0,60	0,031	0,15	0,30
3	4°	15,0	15,3	15,7	∞	∞	0,019	0,30	0,45	0,028	0,15	0,24
3	3°	21,0	21,5	22,3	∞	∞	0,017	0,30	0,30	0,024	0,15	0,18
3	4°	9,0	9,4	9,9	11,2	12,7	0,022	0,30	0,60	0,031	0,15	0,30
3	4°	15,0	15,3	15,7	∞	∞	0,019	0,30	0,45	0,028	0,15	0,24
3	3°	21,0	21,5	22,3	∞	∞	0,017	0,30	0,30	0,024	0,15	0,18
3	4°	9,0	9,4	9,9	11,1	∞	0,022	0,30	0,60	0,031	0,15	0,30
3	4°	15,0	15,3	15,7	∞	∞	0,019	0,30	0,45	0,028	0,15	0,24
3	3°	21,0	21,5	22,3	∞	∞	0,017	0,30	0,30	0,024	0,15	0,18
3	4°	9,0	9,4	9,9	11,1	∞	0,022	0,30	0,60	0,031	0,15	0,30
3	4°	15,0	15,3	15,7	∞	∞	0,019	0,30	0,45	0,028	0,15	0,24
3	3°	21,0	21,5	22,2	∞	∞	0,017	0,30	0,30	0,024	0,15	0,18
3	4°	9,0	9,4	9,8	10,9	∞	0,022	0,30	0,60	0,031	0,15	0,30
3	4°	15,0	15,3	15,7	∞	∞	0,019	0,30	0,45	0,028	0,15	0,24
3	3°	21,0	21,4	22,2	∞	∞	0,017	0,30	0,30	0,024	0,15	0,18

Abmessungen in mm
Dimensions in mm

B

Schaftfräser Vollradius

Ball Nose End Mill



DSK

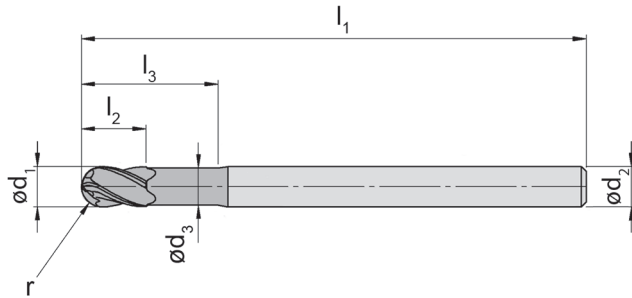
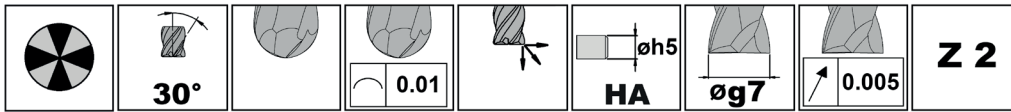

Bestellnummer Part number	d ₁	l ₂	l ₃	d ₂	l ₁	Z	γ	Ausführung Type	TS3K
DSK.2.035.030	3,5	7	10,5	6	64	2	40°	HA	▲
DSK.2.035.050	3,5	7	17,5	6	64	2	40°	HA	▲
DSK.2.035.070	3,5	7	24,5	6	64	2	40°	HA	▲
DSK.2.040.030	4,0	8	12,0	6	64	2	40°	HA	▲
DSK.2.040.050	4,0	8	20,0	6	64	2	40°	HA	▲
DSK.2.040.070	4,0	8	28,0	6	78	2	40°	HA	▲
DSK.2.050.030	5,0	10	15,0	6	64	2	40°	HA	▲
DSK.2.050.050	5,0	10	25,0	6	64	2	40°	HA	▲
DSK.2.050.070	5,0	10	35,0	6	78	2	40°	HA	▲
DSK.2.060.030	6,0	12	18,0	6	64	2	-	HA	▲
DSK.2.060.050	6,0	12	30,0	6	78	2	-	HA	▲
DSK.2.060.070	6,0	12	42,0	6	100	2	-	HA	▲
DSK.2.080.030	8,0	16	24,0	8	64	2	-	HA	▲
DSK.2.080.050	8,0	16	40,0	8	100	2	-	HA	▲
DSK.2.080.070	8,0	16	56,0	8	100	2	-	HA	▲
DSK.2.100.030	10,0	20	30,0	10	78	2	-	HA	▲
DSK.2.100.050	10,0	20	50,0	10	100	2	-	HA	▲
DSK.2.100.070	10,0	20	70,0	10	120	2	-	HA	▲
DSK.2.120.030	12,0	24	36,0	12	100	2	-	HA	▲
DSK.2.120.050	12,0	24	60,0	12	120	2	-	HA	▲
DSK.2.120.070	12,0	24	84,0	12	140	2	-	HA	▲
DSK.2.160.030	16,0	32	48,0	16	100	2	-	HA	▲
DSK.2.160.050	16,0	32	80,0	16	140	2	-	HA	▲
DSK.2.160.070	16,0	32	112,0	16	163	2	-	HA	▲

▲ ab Lager / on stock Δ 4 Wochen / 4 weeks x auf Anfrage / upon request

● empfohlen / recommended

○ bedingt einsetzbar / alternative recommendation

- nicht geeignet / not suitable

■ unbeschichtete HM-Sorten / uncoated grades

■ beschichtete HM-Sorten / coated grades

■ bestückt/Cermet / brazed/Cermet

Abmessungen in mm

Dimensions in mm



P	●
M	○
K	○
N	-
S	○
H	○



HM-Sorten
Carbide grades

Schnittdaten DSK Ø 3,5 - 16,0 mm

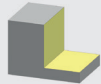

Cutting Data DSK Ø 3,5 - 16,0 mm

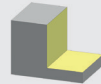

		
	vc = m/min	vc = m/min
P1.1	160	190
P1.2	160	190
P1.3	150	180
P2.1	140	170
P2.2	140	170
P2.3	140	170
P3.1	120	140
P3.2	110	130
M1.1	90	110
M2.1	80	100
M3.1	60	70

		
	vc = m/min	vc = m/min
K1.1	140	170
K1.2	130	160
K2.1	120	140
K2.2	100	120
K3.1	80	100
K3.2	70	80
S1	70	80
S2	55	70
S3	40	50
-	-	-
-	-	-

B

d ₁							
		f _z	a _e	a _p	f _z	a _e	a _p
3,5	5°	0,03	0,35	0,70	0,04	0,18	0,35
3,5	5°	0,03	0,35	0,70	0,04	0,18	0,35
3,5	5°	0,03	0,35	0,70	0,04	0,18	0,35
4,0	5°	0,03	0,40	0,80	0,04	0,20	0,40
4,0	5°	0,03	0,40	0,80	0,04	0,20	0,40
4,0	5°	0,03	0,50	1,00	0,05	0,25	0,50
5,0	5°	0,03	0,50	1,00	0,05	0,25	0,50
5,0	5°	0,03	0,50	1,00	0,05	0,25	0,50
5,0	5°	0,03	0,50	1,00	0,05	0,25	0,50
6,0	5°	0,04	0,60	1,20	0,06	0,30	0,60
6,0	5°	0,04	0,60	1,20	0,06	0,30	0,60
6,0	5°	0,05	0,80	1,60	0,08	0,40	0,80
8,0	5°	0,05	0,80	1,60	0,08	0,40	0,80
8,0	5°	0,05	0,80	1,60	0,08	0,40	0,80
8,0	5°	0,05	0,80	1,60	0,08	0,40	0,80
10,0	5°	0,07	1,00	2,00	0,09	0,50	1,00
10,0	5°	0,07	1,00	2,00	0,09	0,50	1,00
10,0	5°	0,08	1,20	2,40	0,11	0,60	1,20
12,0	5°	0,08	1,20	2,40	0,11	0,60	1,20
12,0	5°	0,08	1,20	2,40	0,11	0,60	1,20
12,0	5°	0,08	1,20	2,40	0,11	0,60	1,20
16,0	5°	0,10	1,60	3,20	0,15	0,80	1,60
16,0	5°	0,10	1,60	3,20	0,15	0,80	1,60
16,0	5°	0,10	1,60	3,20	0,15	0,80	1,60

Abmessungen in mm
Dimensions in mm

DST

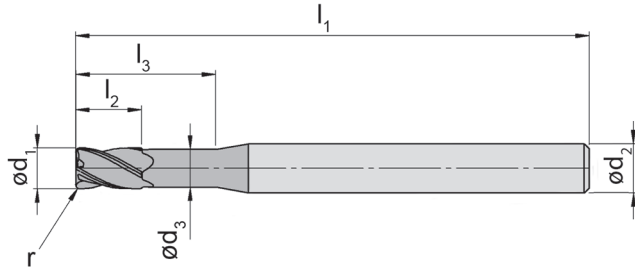
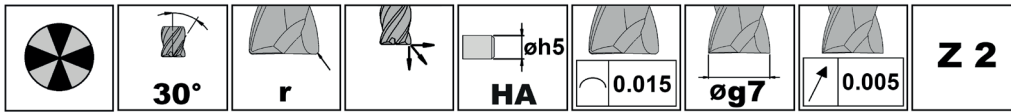

Bestellnummer Part number	d ₁	r	l ₂	l ₃	d ₂	l ₁	Z	γ	Ausführung Type	TS3K
DST.2.035.020.030	3,5	0,2	7	10,5	6	64	2	40°	HA	▲
DST.2.035.020.050	3,5	0,2	7	17,5	6	64	2	40°	HA	▲
DST.2.035.020.070	3,5	0,2	7	24,5	6	64	2	40°	HA	▲
DST.2.035.050.030	3,5	0,5	7	10,5	6	64	2	40°	HA	▲
DST.2.035.050.050	3,5	0,5	7	17,5	6	64	2	40°	HA	▲
DST.2.035.050.070	3,5	0,5	7	24,5	6	64	2	40°	HA	▲
DST.2.035.100.030	3,5	1,0	7	10,5	6	64	2	40°	HA	▲
DST.2.035.100.050	3,5	1,0	7	17,5	6	64	2	40°	HA	▲
DST.2.035.100.070	3,5	1,0	7	24,5	6	64	2	40°	HA	▲
DST.2.040.020.030	4,0	0,2	8	12,0	6	64	2	40°	HA	▲
DST.2.040.020.050	4,0	0,2	8	20,0	6	64	2	40°	HA	▲
DST.2.040.020.070	4,0	0,2	8	28,0	6	78	2	40°	HA	▲
DST.2.040.050.030	4,0	0,5	8	12,0	6	64	2	40°	HA	▲
DST.2.040.050.050	4,0	0,5	8	20,0	6	64	2	40°	HA	▲
DST.2.040.050.070	4,0	0,5	8	28,0	6	78	2	40°	HA	▲
DST.2.040.100.030	4,0	1,0	8	12,0	6	64	2	40°	HA	▲
DST.2.040.100.050	4,0	1,0	8	20,0	6	64	2	40°	HA	▲
DST.2.040.100.070	4,0	1,0	8	28,0	6	78	2	40°	HA	▲
DST.2.050.020.030	5,0	0,2	10	15,0	6	64	2	40°	HA	▲
DST.2.050.020.050	5,0	0,2	10	25,0	6	64	2	40°	HA	▲
DST.2.050.020.070	5,0	0,2	10	35,0	6	78	2	40°	HA	▲
DST.2.050.050.030	5,0	0,5	10	15,0	6	64	2	40°	HA	▲
DST.2.050.050.050	5,0	0,5	10	25,0	6	64	2	40°	HA	▲
DST.2.050.050.070	5,0	0,5	10	35,0	6	78	2	40°	HA	▲
DST.2.050.100.030	5,0	1,0	10	15,0	6	64	2	40°	HA	▲
DST.2.050.100.050	5,0	1,0	10	25,0	6	64	2	40°	HA	▲
DST.2.050.100.070	5,0	1,0	10	35,0	6	78	2	40°	HA	▲

▲ ab Lager / on stock Δ 4 Wochen / 4 weeks x auf Anfrage / upon request

● empfohlen / recommended

○ bedingt einsetzbar / alternative recommendation

- nicht geeignet / not suitable

■ unbeschichtete HM-Sorten / uncoated grades

■ beschichtete HM-Sorten / coated grades



■ bestückt/Cermet / brazed/Cermet



P	●
M	○
K	○
N	-
S	○
H	○

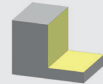

Schnittdaten DST Ø 3,5 - 5,0 mm

Cutting Data DST Ø 3,5 - 5,0 mm

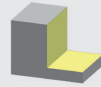

	 vc = m/min	 vc = m/min
P1.1	160	190
P1.2	160	190
P1.3	150	180
P2.1	140	170
P2.2	140	170
P2.3	140	170
P3.1	120	140
P3.2	110	130
M1.1	90	110
M2.1	80	100
M3.1	60	70

	 vc = m/min	 vc = m/min
K1.1	140	170
K1.2	130	160
K2.1	120	140
K2.2	100	120
K3.1	80	100
K3.2	70	80
S1	70	80
S2	55	70
S3	40	50
-	-	-
-	-	-

d ₁	 α						
		f _z	a _e	a _p	f _z	a _e	a _p
3,5	5°	0,025	0,35	0,70	0,036	0,18	0,35
3,5	5°	0,025	0,35	0,70	0,036	0,18	0,35
3,5	5°	0,025	0,35	0,70	0,036	0,18	0,35
3,5	5°	0,025	0,35	0,70	0,036	0,18	0,35
3,5	5°	0,025	0,35	0,70	0,036	0,18	0,35
3,5	5°	0,025	0,35	0,70	0,036	0,18	0,35
3,5	5°	0,025	0,35	0,70	0,036	0,18	0,35
3,5	5°	0,025	0,35	0,70	0,036	0,18	0,35
3,5	5°	0,025	0,35	0,70	0,036	0,18	0,35
3,5	5°	0,025	0,35	0,70	0,036	0,18	0,35
4,0	5°	0,028	0,40	0,80	0,040	0,20	0,40
4,0	5°	0,028	0,40	0,80	0,040	0,20	0,40
4,0	5°	0,028	0,40	0,80	0,040	0,20	0,40
4,0	5°	0,028	0,40	0,80	0,040	0,20	0,40
4,0	5°	0,028	0,40	0,80	0,040	0,20	0,40
4,0	5°	0,028	0,40	0,80	0,040	0,20	0,40
4,0	5°	0,028	0,40	0,80	0,040	0,20	0,40
4,0	5°	0,028	0,40	0,80	0,040	0,20	0,40
4,0	5°	0,028	0,40	0,80	0,040	0,20	0,40
4,0	5°	0,028	0,40	0,80	0,040	0,20	0,40
5,0	5°	0,035	0,50	1,00	0,049	0,25	0,50
5,0	5°	0,035	0,50	1,00	0,049	0,25	0,50
5,0	5°	0,035	0,50	1,00	0,049	0,25	0,50
5,0	5°	0,035	0,50	1,00	0,049	0,25	0,50
5,0	5°	0,035	0,50	1,00	0,049	0,25	0,50
5,0	5°	0,035	0,50	1,00	0,049	0,25	0,50
5,0	5°	0,035	0,50	1,00	0,049	0,25	0,50
5,0	5°	0,035	0,50	1,00	0,049	0,25	0,50
5,0	5°	0,035	0,50	1,00	0,049	0,25	0,50
5,0	5°	0,035	0,50	1,00	0,049	0,25	0,50

Abmessungen in mm
Dimensions in mm

B

DST

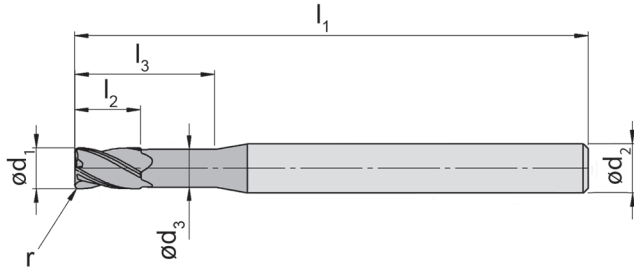
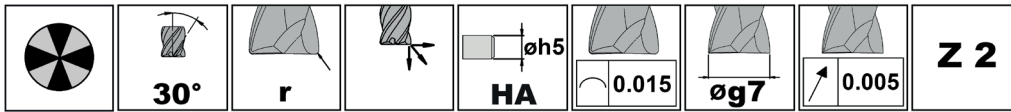

Bestellnummer Part number	d ₁	r	l ₂	l ₃	d ₂	l ₁	Z	Ausführung Type	TS3K
DST.2.060.020.030	6	0,2	12	18	6	64	2	HA	▲
DST.2.060.020.050	6	0,2	12	30	6	78	2	HA	▲
DST.2.060.020.070	6	0,2	12	42	6	100	2	HA	▲
DST.2.060.050.030	6	0,5	12	18	6	64	2	HA	▲
DST.2.060.050.050	6	0,5	12	30	6	78	2	HA	▲
DST.2.060.050.070	6	0,5	12	42	6	100	2	HA	▲
DST.2.060.100.030	6	1,0	12	18	6	64	2	HA	▲
DST.2.060.100.050	6	1,0	12	30	6	78	2	HA	▲
DST.2.060.100.070	6	1,0	12	42	6	100	2	HA	▲
DST.2.060.200.030	6	2,0	12	18	6	64	2	HA	▲
DST.2.060.200.050	6	2,0	12	30	6	78	2	HA	▲
DST.2.060.200.070	6	2,0	12	42	6	100	2	HA	▲
DST.2.080.020.030	8	0,2	16	24	8	64	2	HA	▲
DST.2.080.020.050	8	0,2	16	40	8	100	2	HA	▲
DST.2.080.020.070	8	0,2	16	56	8	100	2	HA	▲
DST.2.080.050.030	8	0,5	16	24	8	64	2	HA	▲
DST.2.080.050.050	8	0,5	16	40	8	100	2	HA	▲
DST.2.080.050.070	8	0,5	16	56	8	100	2	HA	▲
DST.2.080.100.030	8	1,0	16	24	8	64	2	HA	▲
DST.2.080.100.050	8	1,0	16	40	8	100	2	HA	▲
DST.2.080.100.070	8	1,0	16	56	8	100	2	HA	▲
DST.2.080.200.030	8	2,0	16	24	8	64	2	HA	▲
DST.2.080.200.050	8	2,0	16	40	8	100	2	HA	▲
DST.2.080.200.070	8	2,0	16	56	8	100	2	HA	▲

▲ ab Lager / on stock Δ 4 Wochen / 4 weeks x auf Anfrage / upon request

● empfohlen / recommended

○ bedingt einsetzbar / alternative recommendation

- nicht geeignet / not suitable

■ unbeschichtete HM-Sorten / uncoated grades

■ beschichtete HM-Sorten / coated grades

■ bestückt/Cermet / brazed/Cermet

Abmessungen in mm

Dimensions in mm



P	•
M	○
K	○
N	-
S	○
H	○



HM-Sorten
Carbide grades

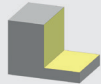

Schnittdaten DST Ø 6,0 - 8,0 mm

Cutting Data DST Ø 6,0 - 8,0 mm

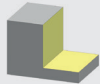

		
	vc = m/min	vc = m/min
P1.1	160	190
P1.2	160	190
P1.3	150	180
P2.1	140	170
P2.2	140	170
P2.3	140	170
P3.1	120	140
P3.2	110	130
M1.1	90	110
M2.1	80	100
M3.1	60	70

		
	vc = m/min	vc = m/min
K1.1	140	170
K1.2	130	160
K2.1	120	140
K2.2	100	120
K3.1	80	100
K3.2	70	80
S1	70	80
S2	55	70
S3	40	50
-	-	-
-	-	-

d ₁							
		f _z	a _e	a _p	f _z	a _e	a _p
6	5°	0,041	0,60	1,20	0,058	0,30	0,60
6	5°	0,041	0,60	1,20	0,058	0,30	0,60
6	5°	0,041	0,60	1,20	0,058	0,30	0,60
6	5°	0,041	0,60	1,20	0,058	0,30	0,60
6	5°	0,041	0,60	1,20	0,058	0,30	0,60
6	5°	0,041	0,60	1,20	0,058	0,30	0,60
6	5°	0,041	0,60	1,20	0,058	0,30	0,60
6	5°	0,041	0,60	1,20	0,058	0,30	0,60
6	5°	0,041	0,60	1,20	0,058	0,30	0,60
6	5°	0,041	0,60	1,20	0,058	0,30	0,60
6	5°	0,041	0,60	1,20	0,058	0,30	0,60
6	5°	0,041	0,60	1,20	0,058	0,30	0,60
6	5°	0,041	0,60	1,20	0,058	0,30	0,60
8	5°	0,054	0,80	1,60	0,076	0,40	0,80
8	5°	0,054	0,80	1,60	0,076	0,40	0,80
8	5°	0,054	0,80	1,60	0,076	0,40	0,80
8	5°	0,054	0,80	1,60	0,076	0,40	0,80
8	5°	0,054	0,80	1,60	0,076	0,40	0,80
8	5°	0,054	0,80	1,60	0,076	0,40	0,80
8	5°	0,054	0,80	1,60	0,076	0,40	0,80
8	5°	0,054	0,80	1,60	0,076	0,40	0,80
8	5°	0,054	0,80	1,60	0,076	0,40	0,80
8	5°	0,054	0,80	1,60	0,076	0,40	0,80
8	5°	0,054	0,80	1,60	0,076	0,40	0,80
8	5°	0,054	0,80	1,60	0,076	0,40	0,80
8	5°	0,054	0,80	1,60	0,076	0,40	0,80
8	5°	0,054	0,80	1,60	0,076	0,40	0,80
8	5°	0,054	0,80	1,60	0,076	0,40	0,80

Abmessungen in mm
Dimensions in mm



DST

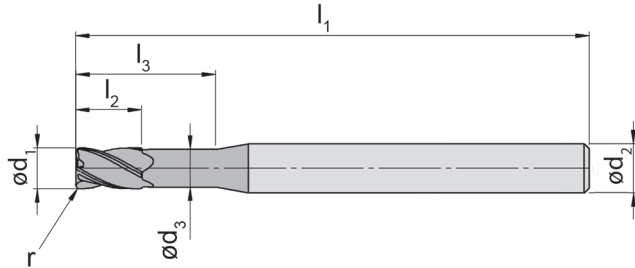
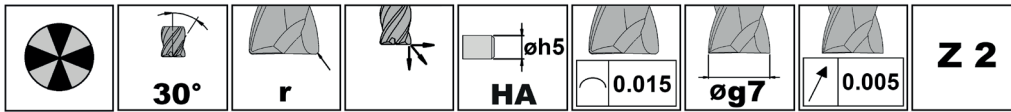

Bestellnummer Part number	d ₁	r	l ₂	l ₃	d ₂	l ₁	Z	Ausführung Type	TS3K
DST.2.100.020.030	10	0,2	20	30	10	78	2	HA	▲
DST.2.100.020.050	10	0,2	20	50	10	100	2	HA	▲
DST.2.100.020.070	10	0,2	20	70	10	120	2	HA	▲
DST.2.100.050.030	10	0,5	20	30	10	78	2	HA	▲
DST.2.100.050.050	10	0,5	20	50	10	100	2	HA	▲
DST.2.100.050.070	10	0,5	20	70	10	120	2	HA	▲
DST.2.100.100.030	10	1,0	20	30	10	78	2	HA	▲
DST.2.100.100.050	10	1,0	20	50	10	100	2	HA	▲
DST.2.100.100.070	10	1,0	20	70	10	120	2	HA	▲
DST.2.100.200.030	10	2,0	20	30	10	78	2	HA	▲
DST.2.100.200.050	10	2,0	20	50	10	100	2	HA	▲
DST.2.100.200.070	10	2,0	20	70	10	120	2	HA	▲
DST.2.120.020.030	12	0,2	24	36	12	100	2	HA	▲
DST.2.120.020.050	12	0,2	24	60	12	120	2	HA	▲
DST.2.120.020.070	12	0,2	24	84	12	140	2	HA	▲
DST.2.120.050.030	12	0,5	24	36	12	100	2	HA	▲
DST.2.120.050.050	12	0,5	24	60	12	120	2	HA	▲
DST.2.120.050.070	12	0,5	24	84	12	140	2	HA	▲
DST.2.120.100.030	12	1,0	24	36	12	100	2	HA	▲
DST.2.120.100.050	12	1,0	24	60	12	120	2	HA	▲
DST.2.120.100.070	12	1,0	24	84	12	140	2	HA	▲
DST.2.120.200.030	12	2,0	24	36	12	100	2	HA	▲
DST.2.120.200.050	12	2,0	24	60	12	120	2	HA	▲
DST.2.120.200.070	12	2,0	24	84	12	140	2	HA	▲

▲ ab Lager / on stock Δ 4 Wochen / 4 weeks x auf Anfrage / upon request

● empfohlen / recommended

○ bedingt einsetzbar / alternative recommendation

- nicht geeignet / not suitable

■ unbeschichtete HM-Sorten / uncoated grades

■ beschichtete HM-Sorten / coated grades

■ bestückt/Cermet / brazed/Cermet

Abmessungen in mm

Dimensions in mm



P	●
M	○
K	○
N	-
S	○
H	○



HM-Sorten
Carbide grades

Schnittdaten DST Ø 10,0 - 12,0 mm

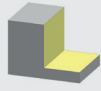
Cutting Data DST Ø 10,0 - 12,0 mm



	 vc = m/min	 vc = m/min
P1.1	160	190
P1.2	160	190
P1.3	150	180
P2.1	140	170
P2.2	140	170
P2.3	140	170
P3.1	120	140
P3.2	110	130
M1.1	90	110
M2.1	80	100
M3.1	60	70

	 vc = m/min	 vc = m/min
K1.1	140	170
K1.2	130	160
K2.1	120	140
K2.2	100	120
K3.1	80	100
K3.2	70	80
S1	70	80
S2	55	70
S3	40	50
-	-	-
-	-	-

B

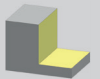
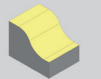
d ₁	 α						
		f _z	a _e	a _p	f _z	a _e	a _p
10	5°	0,066	1,00	2,00	0,094	0,50	1,00
10	5°	0,066	1,00	2,00	0,094	0,50	1,00
10	5°	0,066	1,00	2,00	0,094	0,50	1,00
10	5°	0,066	1,00	2,00	0,094	0,50	1,00
10	5°	0,066	1,00	2,00	0,094	0,50	1,00
10	5°	0,066	1,00	2,00	0,094	0,50	1,00
10	5°	0,066	1,00	2,00	0,094	0,50	1,00
10	5°	0,066	1,00	2,00	0,094	0,50	1,00
10	5°	0,066	1,00	2,00	0,094	0,50	1,00
10	5°	0,066	1,00	2,00	0,094	0,50	1,00
10	5°	0,066	1,00	2,00	0,094	0,50	1,00
10	5°	0,066	1,00	2,00	0,094	0,50	1,00
10	5°	0,066	1,00	2,00	0,094	0,50	1,00
12	5°	0,079	1,20	2,40	0,112	0,60	1,20
12	5°	0,079	1,20	2,40	0,112	0,60	1,20
12	5°	0,079	1,20	2,40	0,112	0,60	1,20
12	5°	0,079	1,20	2,40	0,112	0,60	1,20
12	5°	0,079	1,20	2,40	0,112	0,60	1,20
12	5°	0,079	1,20	2,40	0,112	0,60	1,20
12	5°	0,079	1,20	2,40	0,112	0,60	1,20
12	5°	0,079	1,20	2,40	0,112	0,60	1,20
12	5°	0,079	1,20	2,40	0,112	0,60	1,20
12	5°	0,079	1,20	2,40	0,112	0,60	1,20
12	5°	0,079	1,20	2,40	0,112	0,60	1,20
12	5°	0,079	1,20	2,40	0,112	0,60	1,20
12	5°	0,079	1,20	2,40	0,112	0,60	1,20
12	5°	0,079	1,20	2,40	0,112	0,60	1,20
12	5°	0,079	1,20	2,40	0,112	0,60	1,20
12	5°	0,079	1,20	2,40	0,112	0,60	1,20

Abmessungen in mm
Dimensions in mm

Torusfräser

Torus End Mill



DST

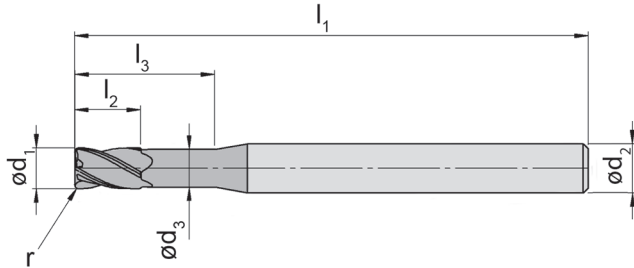
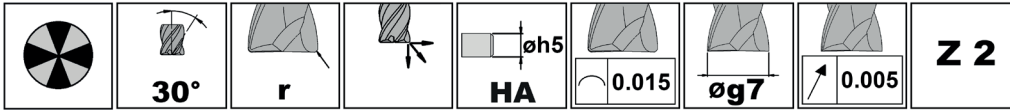

Bestellnummer Part number	d ₁	r	l ₂	l ₃	d ₂	l ₁	Z	Ausführung Type	TS3K
DST.2.160.020.030	16	0,2	32	48	16	100	2	HA	▲
DST.2.160.020.050	16	0,2	32	80	16	140	2	HA	▲
DST.2.160.020.070	16	0,2	32	112	16	163	2	HA	▲
DST.2.160.050.030	16	0,5	32	48	16	100	2	HA	▲
DST.2.160.050.050	16	0,5	32	80	16	140	2	HA	▲
DST.2.160.050.070	16	0,5	32	112	16	163	2	HA	▲
DST.2.160.100.030	16	1,0	32	48	16	100	2	HA	▲
DST.2.160.100.050	16	1,0	32	80	16	140	2	HA	▲
DST.2.160.100.070	16	1,0	32	112	16	163	2	HA	▲
DST.2.160.200.030	16	2,0	32	48	16	100	2	HA	▲
DST.2.160.200.050	16	2,0	32	80	16	140	2	HA	▲
DST.2.160.200.070	16	2,0	32	112	16	163	2	HA	▲

▲ ab Lager / on stock Δ 4 Wochen / 4 weeks x auf Anfrage / upon request

● empfohlen / recommended

o bedingt einsetzbar / alternative recommendation

- nicht geeignet / not suitable

■ unbeschichtete HM-Sorten / uncoated grades

■ beschichtete HM-Sorten / coated grades

■ bestückt/Cermet / brazed/Cermet

Abmessungen in mm

Dimensions in mm



P	●
M	○
K	○
N	-
S	○
H	○



HM-Sorten
Carbide grades

Schnittdaten DST Ø 16,0 mm

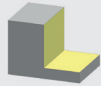

Cutting Data DST Ø 16,0 mm

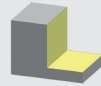

	 vc = m/min	 vc = m/min
P1.1	160	190
P1.2	160	190
P1.3	150	180
P2.1	140	170
P2.2	140	170
P2.3	140	170
P3.1	120	140
P3.2	110	130
M1.1	90	110
M2.1	80	100
M3.1	60	70

	 vc = m/min	 vc = m/min
K1.1	140	170
K1.2	130	160
K2.1	120	140
K2.2	100	120
K3.1	80	100
K3.2	70	80
S1	70	80
S2	55	70
S3	40	50
-	-	-
-	-	-



d_1	 α						
		f_z	a_e	a_p	f_z	a_e	a_p
16	5°	0,104	1,60	3,20	0,147	0,80	1,60
16	5°	0,104	1,60	3,20	0,147	0,80	1,60
16	5°	0,104	1,60	3,20	0,147	0,80	1,60
16	5°	0,104	1,60	3,20	0,147	0,80	1,60
16	5°	0,104	1,60	3,20	0,147	0,80	1,60
16	5°	0,104	1,60	3,20	0,147	0,80	1,60
16	5°	0,104	1,60	3,20	0,147	0,80	1,60
16	5°	0,104	1,60	3,20	0,147	0,80	1,60
16	5°	0,104	1,60	3,20	0,147	0,80	1,60
16	5°	0,104	1,60	3,20	0,147	0,80	1,60
16	5°	0,104	1,60	3,20	0,147	0,80	1,60
16	5°	0,104	1,60	3,20	0,147	0,80	1,60

Abmessungen in mm
Dimensions in mm

DST

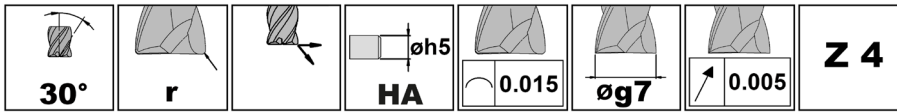

B

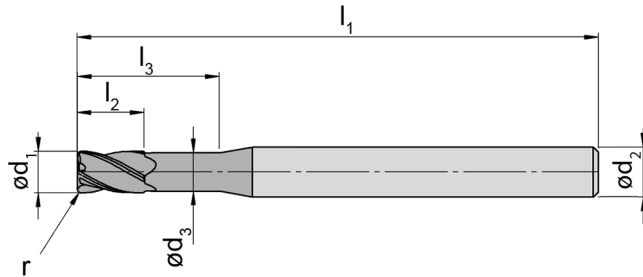

Bestellnummer Part number	d ₁	r	l ₂	l ₃	d ₂	l ₁	Z	γ	Ausführung Type	TS3K
DST.4.035.020.030	3,5	0,2	7	10,5	6	64	4	40°	HA	▲
DST.4.035.020.050	3,5	0,2	7	17,5	6	64	4	40°	HA	▲
DST.4.035.020.070	3,5	0,2	7	24,5	6	64	4	40°	HA	▲
DST.4.035.050.030	3,5	0,5	7	10,5	6	64	4	40°	HA	▲
DST.4.035.050.050	3,5	0,5	7	17,5	6	64	4	40°	HA	▲
DST.4.035.050.070	3,5	0,5	7	24,5	6	64	4	40°	HA	▲
DST.4.035.100.030	3,5	1,0	7	10,5	6	64	4	40°	HA	▲
DST.4.035.100.050	3,5	1,0	7	17,5	6	64	4	40°	HA	▲
DST.4.035.100.070	3,5	1,0	7	24,5	6	64	4	40°	HA	▲
DST.4.040.020.030	4,0	0,2	8	12,0	6	64	4	40°	HA	▲
DST.4.040.020.050	4,0	0,2	8	20,0	6	64	4	40°	HA	▲
DST.4.040.020.070	4,0	0,2	8	28,0	6	78	4	40°	HA	▲
DST.4.040.050.030	4,0	0,5	8	12,0	6	64	4	40°	HA	▲
DST.4.040.050.050	4,0	0,5	8	20,0	6	64	4	40°	HA	▲
DST.4.040.050.070	4,0	0,5	8	28,0	6	78	4	40°	HA	▲
DST.4.040.100.030	4,0	1,0	8	12,0	6	64	4	40°	HA	▲
DST.4.040.100.050	4,0	1,0	8	20,0	6	64	4	40°	HA	▲
DST.4.040.100.070	4,0	1,0	8	28,0	6	78	4	40°	HA	▲

▲ ab Lager / on stock Δ 4 Wochen / 4 weeks x auf Anfrage / upon request

● empfohlen / recommended

o bedingt einsetzbar / alternative recommendation

- nicht geeignet / not suitable

■ unbeschichtete HM-Sorten / uncoated grades

■ beschichtete HM-Sorten / coated grades

■ bestückt/Cermet / brazed/Cermet

Abmessungen in mm

Dimensions in mm



P	●
M	○
K	○
N	-
S	○
H	○



HM-Sorten
Carbide grades

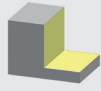

Schnittdaten DST Ø 3,5 - 4,0 mm

Cutting Data DST Ø 3,5 - 4,0 mm

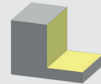

		
	vc = m/min	vc = m/min
P1.1	160	190
P1.2	160	190
P1.3	150	180
P2.1	140	170
P2.2	140	170
P2.3	140	170
P3.1	120	140
P3.2	110	130
M1.1	90	110
M2.1	80	100
M3.1	60	70

		
	vc = m/min	vc = m/min
K1.1	140	170
K1.2	130	160
K2.1	120	140
K2.2	100	120
K3.1	80	100
K3.2	70	80
S1	70	80
S2	55	70
S3	40	50
-	-	-
-	-	-

d ₁							
		f _z	a _e	a _p	f _z	a _e	a _p
3,5	4°	0,025	0,35	0,70	0,035	0,18	0,35
3,5	4°	0,025	0,35	0,70	0,035	0,18	0,35
3,5	4°	0,025	0,35	0,70	0,035	0,18	0,35
3,5	4°	0,025	0,35	0,70	0,035	0,18	0,35
3,5	4°	0,025	0,35	0,70	0,035	0,18	0,35
3,5	4°	0,025	0,35	0,70	0,035	0,18	0,35
3,5	4°	0,025	0,35	0,70	0,035	0,18	0,35
3,5	4°	0,025	0,35	0,70	0,035	0,18	0,35
3,5	4°	0,025	0,35	0,70	0,035	0,18	0,35
4,0	4°	0,025	0,35	0,70	0,035	0,18	0,35
4,0	4°	0,028	0,40	0,80	0,040	0,20	0,40
4,0	4°	0,028	0,40	0,80	0,040	0,20	0,40
4,0	4°	0,028	0,40	0,80	0,040	0,20	0,40
4,0	4°	0,028	0,40	0,80	0,040	0,20	0,40
4,0	4°	0,028	0,40	0,80	0,040	0,20	0,40
4,0	4°	0,028	0,40	0,80	0,040	0,20	0,40
4,0	4°	0,028	0,40	0,80	0,040	0,20	0,40
4,0	4°	0,028	0,40	0,80	0,040	0,20	0,40
4,0	4°	0,028	0,40	0,80	0,040	0,20	0,40

Abmessungen in mm
Dimensions in mm

B

DST

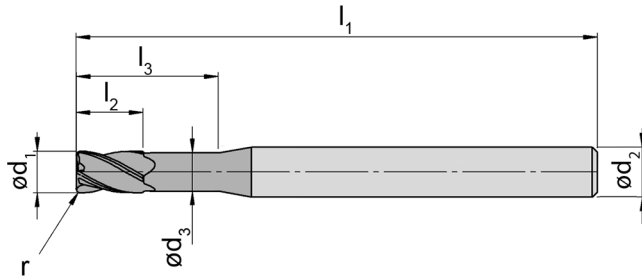
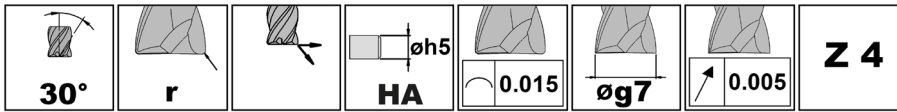

Bestellnummer Part number	d ₁	r	l ₂	l ₃	d ₂	l ₁	Z	γ	Ausführung Type	TS3K
DST.4.050.020.030	5	0,2	10	15	6	64	4	40°	HA	▲
DST.4.050.020.050	5	0,2	10	25	6	64	4	40°	HA	▲
DST.4.050.020.070	5	0,2	10	35	6	78	4	40°	HA	▲
DST.4.050.050.030	5	0,5	10	15	6	64	4	40°	HA	▲
DST.4.050.050.050	5	0,5	10	25	6	64	4	40°	HA	▲
DST.4.050.050.070	5	0,5	10	35	6	78	4	40°	HA	▲
DST.4.050.100.030	5	1,0	10	15	6	64	4	40°	HA	▲
DST.4.050.100.050	5	1,0	10	25	6	64	4	40°	HA	▲
DST.4.050.100.070	5	1,0	10	35	6	78	4	40°	HA	▲
DST.4.060.020.030	6	0,2	12	18	6	64	4	-	HA	▲
DST.4.060.020.050	6	0,2	12	30	6	78	4	-	HA	▲
DST.4.060.020.070	6	0,2	12	42	6	100	4	-	HA	▲
DST.4.060.050.030	6	0,5	12	18	6	64	4	-	HA	▲
DST.4.060.050.050	6	0,5	12	30	6	78	4	-	HA	▲
DST.4.060.050.070	6	0,5	12	42	6	100	4	-	HA	▲
DST.4.060.100.030	6	1,0	12	18	6	64	4	-	HA	▲
DST.4.060.100.050	6	1,0	12	30	6	78	4	-	HA	▲
DST.4.060.100.070	6	1,0	12	42	6	100	4	-	HA	▲
DST.4.060.200.030	6	2,0	12	18	6	64	4	-	HA	▲
DST.4.060.200.050	6	2,0	12	30	6	78	4	-	HA	▲
DST.4.060.200.070	6	2,0	12	42	6	100	4	-	HA	▲

▲ ab Lager / on stock Δ 4 Wochen / 4 weeks x auf Anfrage / upon request

● empfohlen / recommended

o bedingt einsetzbar / alternative recommendation

- nicht geeignet / not suitable

■ unbeschichtete HM-Sorten / uncoated grades

■ beschichtete HM-Sorten / coated grades

■ bestückt/Cermet / brazed/Cermet

Abmessungen in mm

Dimensions in mm



P	●
M	○
K	○
N	-
S	○
H	○



HM-Sorten
Carbide grades

Schnittdaten DST Ø 5,0 - 6,0 mm

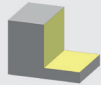

Cutting Data DST Ø 5,0 - 6,0 mm

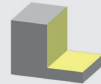

	 vc = m/min	 vc = m/min
P1.1	160	190
P1.2	160	190
P1.3	150	180
P2.1	140	170
P2.2	140	170
P2.3	140	170
P3.1	120	140
P3.2	110	130
M1.1	90	110
M2.1	80	100
M3.1	60	70

	 vc = m/min	 vc = m/min
K1.1	140	170
K1.2	130	160
K2.1	120	140
K2.2	100	120
K3.1	80	100
K3.2	70	80
S1	70	80
S2	55	70
S3	40	50
-	-	-
-	-	-



d ₁	 α						
		f _z	a _e	a _p	f _z	a _e	a _p
5	4°	0,034	0,50	1,00	0,048	0,25	0,50
5	4°	0,034	0,50	1,00	0,048	0,25	0,50
5	4°	0,034	0,50	1,00	0,048	0,25	0,50
5	4°	0,034	0,50	1,00	0,048	0,25	0,50
5	4°	0,034	0,50	1,00	0,048	0,25	0,50
5	4°	0,034	0,50	1,00	0,048	0,25	0,50
5	4°	0,034	0,50	1,00	0,048	0,25	0,50
5	4°	0,034	0,50	1,00	0,048	0,25	0,50
5	4°	0,034	0,50	1,00	0,048	0,25	0,50
5	4°	0,034	0,50	1,00	0,048	0,25	0,50
6	4°	0,041	0,60	1,20	0,057	0,30	0,60
6	4°	0,041	0,60	1,20	0,057	0,30	0,60
6	4°	0,041	0,60	1,20	0,057	0,30	0,60
6	4°	0,041	0,60	1,20	0,057	0,30	0,60
6	4°	0,041	0,60	1,20	0,057	0,30	0,60
6	4°	0,041	0,60	1,20	0,057	0,30	0,60
6	4°	0,041	0,60	1,20	0,057	0,30	0,60
6	4°	0,041	0,60	1,20	0,057	0,30	0,60
6	4°	0,041	0,60	1,20	0,057	0,30	0,60
6	4°	0,041	0,60	1,20	0,057	0,30	0,60
6	4°	0,041	0,60	1,20	0,057	0,30	0,60
6	4°	0,041	0,60	1,20	0,057	0,30	0,60
6	4°	0,041	0,60	1,20	0,057	0,30	0,60
6	4°	0,041	0,60	1,20	0,057	0,30	0,60
6	4°	0,041	0,60	1,20	0,057	0,30	0,60
6	4°	0,041	0,60	1,20	0,057	0,30	0,60

Abmessungen in mm
Dimensions in mm

Torusfräser

Torus End Mill



DST

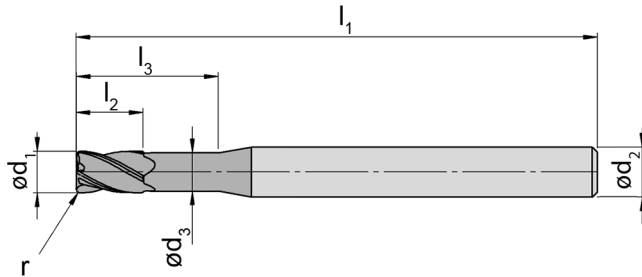
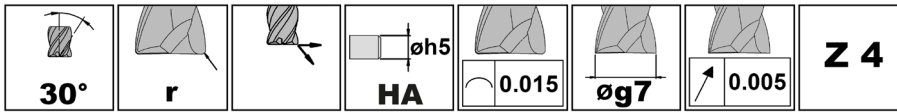

Bestellnummer Part number	d ₁	r	l ₂	l ₃	d ₂	l ₁	Z	Ausführung Type	TS3K
DST.4.080.020.030	8	0,2	16	24	8	64	4	HA	▲
DST.4.080.020.050	8	0,2	16	40	8	100	4	HA	▲
DST.4.080.020.070	8	0,2	16	56	8	100	4	HA	▲
DST.4.080.050.030	8	0,5	16	24	8	64	4	HA	▲
DST.4.080.050.050	8	0,5	16	40	8	100	4	HA	▲
DST.4.080.050.070	8	0,5	16	56	8	100	4	HA	▲
DST.4.080.100.030	8	1,0	16	24	8	64	4	HA	▲
DST.4.080.100.050	8	1,0	16	40	8	100	4	HA	▲
DST.4.080.100.070	8	1,0	16	56	8	100	4	HA	▲
DST.4.080.200.030	8	2,0	16	24	8	64	4	HA	▲
DST.4.080.200.050	8	2,0	16	40	8	100	4	HA	▲
DST.4.080.200.070	8	2,0	16	56	8	100	4	HA	▲
DST.4.100.020.030	10	0,2	20	30	10	78	4	HA	▲
DST.4.100.020.050	10	0,2	20	50	10	100	4	HA	▲
DST.4.100.020.070	10	0,2	20	70	10	120	4	HA	▲
DST.4.100.050.030	10	0,5	20	30	10	78	4	HA	▲
DST.4.100.050.050	10	0,5	20	50	10	100	4	HA	▲
DST.4.100.050.070	10	0,5	20	70	10	120	4	HA	▲
DST.4.100.100.030	10	1,0	20	30	10	78	4	HA	▲
DST.4.100.100.050	10	1,0	20	50	10	100	4	HA	▲
DST.4.100.100.070	10	1,0	20	70	10	120	4	HA	▲
DST.4.100.200.030	10	2,0	20	30	10	78	4	HA	▲
DST.4.100.200.050	10	2,0	20	50	10	100	4	HA	▲
DST.4.100.200.070	10	2,0	20	70	10	120	4	HA	▲

▲ ab Lager / on stock Δ 4 Wochen / 4 weeks x auf Anfrage / upon request

● empfohlen / recommended

○ bedingt einsetzbar / alternative recommendation

- nicht geeignet / not suitable

■ unbeschichtete HM-Sorten / uncoated grades

■ beschichtete HM-Sorten / coated grades

■ bestückt/Cermet / brazed/Cermet

Abmessungen in mm

Dimensions in mm



P	•
M	○
K	○
N	-
S	○
H	○



HM-Sorten
Carbide grades

Schnittdaten DST Ø 8,0 - 10,0 mm



Cutting Data DST Ø 8,0 - 10,0 mm



	 vc = m/min	 vc = m/min
P1.1	160	190
P1.2	160	190
P1.3	150	180
P2.1	140	170
P2.2	140	170
P2.3	140	170
P3.1	120	140
P3.2	110	130
M1.1	90	110
M2.1	80	100
M3.1	60	70

	 vc = m/min	 vc = m/min
K1.1	140	170
K1.2	130	160
K2.1	120	140
K2.2	100	120
K3.1	80	100
K3.2	70	80
S1	70	80
S2	55	70
S3	40	50
-	-	-
-	-	-



d ₁							
		f _z	a _e	a _p	f _z	a _e	a _p
8	4°	0,053	0,80	1,60	0,075	0,40	0,80
8	4°	0,053	0,80	1,60	0,075	0,40	0,80
8	4°	0,053	0,80	1,60	0,075	0,40	0,80
8	4°	0,053	0,80	1,60	0,075	0,40	0,80
8	4°	0,053	0,80	1,60	0,075	0,40	0,80
8	4°	0,053	0,80	1,60	0,075	0,40	0,80
8	4°	0,053	0,80	1,60	0,075	0,40	0,80
8	4°	0,053	0,80	1,60	0,075	0,40	0,80
8	4°	0,053	0,80	1,60	0,075	0,40	0,80
8	4°	0,053	0,80	1,60	0,075	0,40	0,80
8	4°	0,053	0,80	1,60	0,075	0,40	0,80
8	4°	0,053	0,80	1,60	0,075	0,40	0,80
8	4°	0,053	0,80	1,60	0,075	0,40	0,80
10	4°	0,066	1,00	2,00	0,093	0,50	1,00
10	4°	0,066	1,00	2,00	0,093	0,50	1,00
10	4°	0,066	1,00	2,00	0,093	0,50	1,00
10	4°	0,066	1,00	2,00	0,093	0,50	1,00
10	4°	0,066	1,00	2,00	0,093	0,50	1,00
10	4°	0,066	1,00	2,00	0,093	0,50	1,00
10	4°	0,066	1,00	2,00	0,093	0,50	1,00
10	4°	0,066	1,00	2,00	0,093	0,50	1,00
10	4°	0,066	1,00	2,00	0,093	0,50	1,00
10	4°	0,066	1,00	2,00	0,093	0,50	1,00
10	4°	0,066	1,00	2,00	0,093	0,50	1,00
10	4°	0,066	1,00	2,00	0,093	0,50	1,00
10	4°	0,066	1,00	2,00	0,093	0,50	1,00
10	4°	0,066	1,00	2,00	0,093	0,50	1,00
10	4°	0,066	1,00	2,00	0,093	0,50	1,00
10	4°	0,066	1,00	2,00	0,093	0,50	1,00
10	4°	0,066	1,00	2,00	0,093	0,50	1,00

Abmessungen in mm
Dimensions in mm

Torusfräser

Torus End Mill



DST

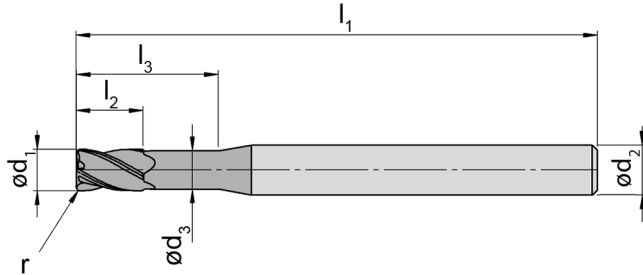
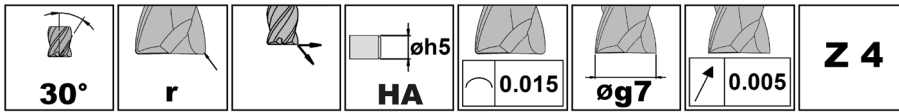

Bestellnummer Part number	d ₁	r	l ₂	l ₃	d ₂	l ₁	Z	Ausführung Type	TS3K
DST.4.120.020.030	12	0,2	24	36	12	100	4	HA	▲
DST.4.120.020.050	12	0,2	24	60	12	120	4	HA	▲
DST.4.120.020.070	12	0,2	24	84	12	140	4	HA	▲
DST.4.120.050.030	12	0,5	24	36	12	100	4	HA	▲
DST.4.120.050.050	12	0,5	24	60	12	120	4	HA	▲
DST.4.120.050.070	12	0,5	24	84	12	140	4	HA	▲
DST.4.120.100.030	12	1,0	24	36	12	100	4	HA	▲
DST.4.120.100.050	12	1,0	24	60	12	120	4	HA	▲
DST.4.120.100.070	12	1,0	24	84	12	140	4	HA	▲
DST.4.120.200.030	12	2,0	24	36	12	100	4	HA	▲
DST.4.120.200.050	12	2,0	24	60	12	120	4	HA	▲
DST.4.120.200.070	12	2,0	24	84	12	140	4	HA	▲
DST.4.160.020.030	16	0,2	32	48	16	100	4	HA	▲
DST.4.160.020.050	16	0,2	32	80	16	140	4	HA	▲
DST.4.160.020.070	16	0,2	32	112	16	163	4	HA	▲
DST.4.160.050.030	16	0,5	32	48	16	100	4	HA	▲
DST.4.160.050.050	16	0,5	32	80	16	140	4	HA	▲
DST.4.160.050.070	16	0,5	32	112	16	163	4	HA	▲
DST.4.160.100.030	16	1,0	32	48	16	100	4	HA	▲
DST.4.160.100.050	16	1,0	32	80	16	140	4	HA	▲
DST.4.160.100.070	16	1,0	32	112	16	163	4	HA	▲
DST.4.160.200.030	16	2,0	32	48	16	100	4	HA	▲
DST.4.160.200.050	16	2,0	32	80	16	140	4	HA	▲
DST.4.160.200.070	16	2,0	32	112	16	163	4	HA	▲

▲ ab Lager / on stock Δ 4 Wochen / 4 weeks x auf Anfrage / upon request

● empfohlen / recommended

○ bedingt einsetzbar / alternative recommendation

- nicht geeignet / not suitable

■ unbeschichtete HM-Sorten / uncoated grades

■ beschichtete HM-Sorten / coated grades

■ bestückt/Cermet / brazed/Cermet

Abmessungen in mm

Dimensions in mm



P	•
M	○
K	○
N	-
S	○
H	○



HM-Sorten
Carbide grades

Schnittdaten DST Ø 12,0 - 16,0 mm

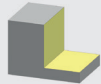

Cutting Data DST Ø 12,0 - 16,0 mm

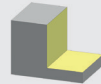

		
	vc = m/min	vc = m/min
P1.1	160	190
P1.2	160	190
P1.3	150	180
P2.1	140	170
P2.2	140	170
P2.3	140	170
P3.1	120	140
P3.2	110	130
M1.1	90	110
M2.1	80	100
M3.1	60	70

		
	vc = m/min	vc = m/min
K1.1	140	170
K1.2	130	160
K2.1	120	140
K2.2	100	120
K3.1	80	100
K3.2	70	80
S1	70	80
S2	55	70
S3	40	50
-	-	-
-	-	-



d ₁							
		f _z	a _e	a _p	f _z	a _e	a _p
12	4°	0,066	1,00	2,00	0,093	0,50	1,00
12	4°	0,079	1,20	2,40	0,111	0,60	1,20
12	4°	0,079	1,20	2,40	0,111	0,60	1,20
12	4°	0,079	1,20	2,40	0,111	0,60	1,20
12	4°	0,079	1,20	2,40	0,111	0,60	1,20
12	4°	0,079	1,20	2,40	0,111	0,60	1,20
12	4°	0,079	1,20	2,40	0,111	0,60	1,20
12	4°	0,079	1,20	2,40	0,111	0,60	1,20
12	4°	0,079	1,20	2,40	0,111	0,60	1,20
12	4°	0,079	1,20	2,40	0,111	0,60	1,20
12	4°	0,079	1,20	2,40	0,111	0,60	1,20
12	4°	0,079	1,20	2,40	0,111	0,60	1,20
12	4°	0,079	1,20	2,40	0,111	0,60	1,20
16	4°	0,104	1,60	3,20	0,147	0,80	1,60
16	4°	0,104	1,60	3,20	0,147	0,80	1,60
16	4°	0,104	1,60	3,20	0,147	0,80	1,60
16	4°	0,104	1,60	3,20	0,147	0,80	1,60
16	4°	0,104	1,60	3,20	0,147	0,80	1,60
16	4°	0,104	1,60	3,20	0,147	0,80	1,60
16	4°	0,104	1,60	3,20	0,147	0,80	1,60
16	4°	0,104	1,60	3,20	0,147	0,80	1,60
16	4°	0,104	1,60	3,20	0,147	0,80	1,60
16	4°	0,104	1,60	3,20	0,147	0,80	1,60
16	4°	0,104	1,60	3,20	0,147	0,80	1,60
16	4°	0,104	1,60	3,20	0,147	0,80	1,60
16	4°	0,104	1,60	3,20	0,147	0,80	1,60
16	4°	0,104	1,60	3,20	0,147	0,80	1,60
16	4°	0,104	1,60	3,20	0,147	0,80	1,60
16	4°	0,104	1,60	3,20	0,147	0,80	1,60
16	4°	0,104	1,60	3,20	0,147	0,80	1,60

Abmessungen in mm
Dimensions in mm

Schaftfräser Mehrschneider

End Mill multiple fluted



DSM

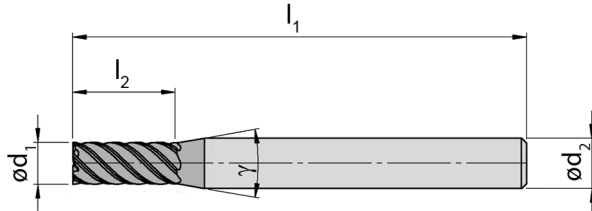
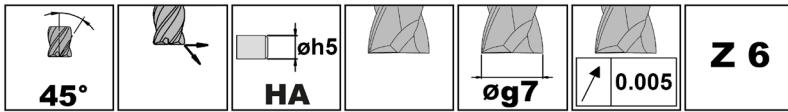

Bis Ø 3 mm vormontiert lieferbar für Toodle Schnellaufspindel
Pre-assembled available up to Ø 3 mm for Toodle high-speed spindle

Bestellnummer Part number	d ₁	l ₂	d ₂	l ₁	Z	γ	TS3K
DSM.6.020.20	2	4	6	57	6	40°	▲
DSM.6.020.30	2	6	6	57	6	40°	▲
DSM.6.020.40	2	8	6	57	6	40°	▲
DSM.6.030.20	3	6	6	57	6	40°	▲
DSM.6.030.30	3	9	6	57	6	40°	▲
DSM.6.030.40	3	12	6	57	6	40°	▲
DSM.6.040.20	4	8	6	57	6	40°	▲
DSM.6.040.30	4	12	6	57	6	40°	▲
DSM.6.040.40	4	16	6	57	6	40°	▲
DSM.6.050.20	5	10	6	57	6	40°	▲
DSM.6.050.30	5	15	6	57	6	40°	▲
DSM.6.050.40	5	20	6	57	6	40°	▲
DSM.6.060.20	6	12	6	50	6	-	▲
DSM.6.060.30	6	18	6	57	6	-	▲
DSM.6.060.40	6	24	6	64	6	-	▲

▲ ab Lager / on stock Δ 4 Wochen / 4 weeks x auf Anfrage / upon request

● empfohlen / recommended

o bedingt einsetzbar / alternative recommendation

- nicht geeignet / not suitable

■ unbeschichtete HM-Sorten / uncoated grades

■ beschichtete HM-Sorten / coated grades

■ bestückt/Cermet / brazed/Cermet

Abmessungen in mm

Dimensions in mm



P	●
M	○
K	○
N	-
S	○
H	○



HM-Sorten
Carbide grades

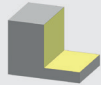

Schnittdaten DSM Ø 2,0 - 6,0 mm

Cutting Data DSM Ø 2,0 - 6,0 mm

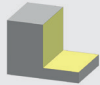

	 $vc = m/min$	 $vc = m/min$
P1.1	140	170
P1.2	140	170
P1.3	130	160
P2.1	120	140
P2.2	120	140
P2.3	120	140
P3.1	100	120
P3.2	90	110
M1.1	80	100
M2.1	60	70
M3.1	45	50

	 $vc = m/min$	 $vc = m/min$
K1.1	120	140
K1.2	100	120
K2.1	100	120
K2.2	80	100
K3.1	70	80
K3.2	60	70
S1	55	70
S2	40	50
S3	35	40
-	-	-
-	-	-

d_1	 α						
		f_z	a_e	a_p	f_z	a_e	a_p
2	2°	0,007	0,20	4,00	0,004	0,06	4,00
2	2°	0,007	0,20	4,00	0,004	0,06	4,00
2	2°	0,007	0,20	4,00	0,004	0,06	4,00
3	2°	0,011	0,30	6,00	0,011	0,09	6,00
3	2°	0,011	0,30	6,00	0,011	0,09	6,00
3	2°	0,011	0,30	6,00	0,011	0,09	6,00
4	2°	0,015	0,40	8,00	0,017	0,12	8,00
4	2°	0,015	0,40	8,00	0,017	0,12	8,00
4	2°	0,008	0,40	8,00	0,017	0,12	8,00
5	2°	0,012	0,50	10,00	0,024	0,15	10,00
5	2°	0,012	0,50	10,00	0,024	0,15	10,00
5	2°	0,012	0,50	10,00	0,024	0,15	10,00
6	2°	0,016	0,60	12,00	0,030	0,18	12,00
6	2°	0,016	0,60	12,00	0,030	0,18	12,00
6	2°	0,016	0,60	12,00	0,030	0,18	12,00

Abmessungen in mm
Dimensions in mm

B

Schaftfräser Mehrschneider

End Mill multiple fluted



DSM

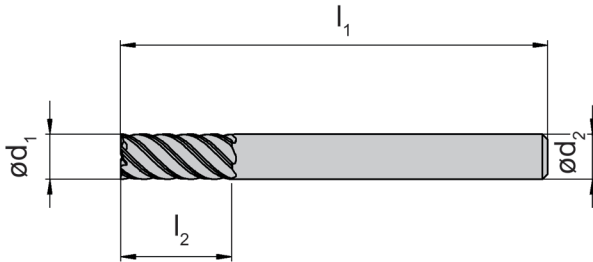
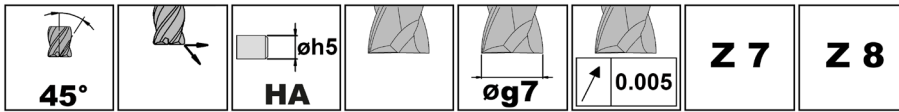

Bestellnummer Part number	d ₁	l ₂	d ₂	l ₁	Z	TS3K
DSM.7.080.20	8	16	8	54	7	▲
DSM.7.080.30	8	24	8	64	7	▲
DSM.7.080.40	8	32	8	78	7	▲
DSM.7.100.20	10	20	10	60	7	▲
DSM.7.100.30	10	30	10	70	7	▲
DSM.7.100.40	10	40	10	89	7	▲
DSM.7.120.20	12	24	12	78	7	▲
DSM.7.120.30	12	36	12	83	7	▲
DSM.7.120.40	12	48	12	100	7	▲
DSM.8.160.20	16	32	16	89	8	▲
DSM.8.160.30	16	48	16	100	8	▲
DSM.8.160.40	16	64	16	120	8	▲
DSM.8.200.20	20	40	20	102	8	▲
DSM.8.200.30	20	60	20	125	8	▲
DSM.8.200.40	20	80	20	150	8	▲

▲ ab Lager / on stock Δ 4 Wochen / 4 weeks x auf Anfrage / upon request

● empfohlen / recommended

o bedingt einsetzbar / alternative recommendation

- nicht geeignet / not suitable

■ unbeschichtete HM-Sorten / uncoated grades

■ beschichtete HM-Sorten / coated grades

■ bestückt/Cermet / brazed/Cermet

Abmessungen in mm

Dimensions in mm



P	●
M	○
K	○
N	-
S	○
H	○



HM-Sorten
Carbide grades

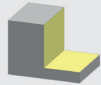

Schnittdaten DSM Ø 8,0 - 20,0 mm

Cutting Data DSM Ø 8,0 - 20,0 mm

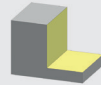

	 vc = m/min	 vc = m/min
P1.1	140	170
P1.2	140	170
P1.3	130	160
P2.1	120	140
P2.2	120	140
P2.3	120	140
P3.1	100	120
P3.2	90	110
M1.1	80	100
M2.1	60	70
M3.1	45	50

	 vc = m/min	 vc = m/min
K1.1	120	140
K1.2	100	120
K2.1	100	120
K2.2	80	100
K3.1	70	80
K3.2	60	70
S1	55	70
S2	40	50
S3	35	40
-	-	-
-	-	-

d ₁	 α						
		f _z	a _e	a _p	f _z	a _e	a _p
8	2°	0,019	0,80	16,00	0,038	0,24	16,00
8	2°	0,019	0,80	16,00	0,038	0,24	16,00
8	2°	0,019	0,80	16,00	0,038	0,24	16,00
10	2°	0,027	1,00	20,00	0,050	0,30	20,00
10	2°	0,027	1,00	20,00	0,050	0,30	20,00
10	2°	0,027	1,00	20,00	0,050	0,30	20,00
12	2°	0,035	1,20	24,00	0,063	0,36	24,00
12	2°	0,035	1,20	24,00	0,063	0,36	24,00
12	2°	0,035	1,20	24,00	0,063	0,36	24,00
16	2°	0,047	1,60	32,00	0,085	0,48	32,00
16	2°	0,047	1,60	32,00	0,085	0,48	32,00
16	2°	0,047	1,60	32,00	0,085	0,48	32,00
20	2°	0,062	2,00	40,00	0,110	0,60	40,00
20	2°	0,062	2,00	40,00	0,110	0,60	40,00
20	2°	0,062	2,00	40,00	0,110	0,60	40,00

Abmessungen in mm
Dimensions in mm



Schaftfräser Mehrschneider, Radius

End Mill multiple fluted, radius



DSMR

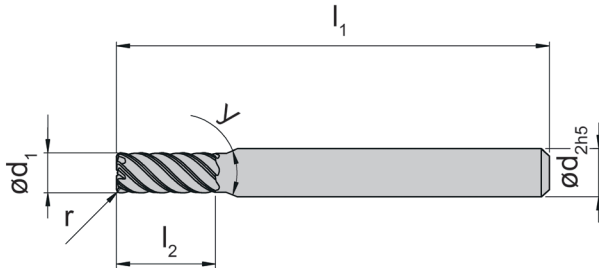
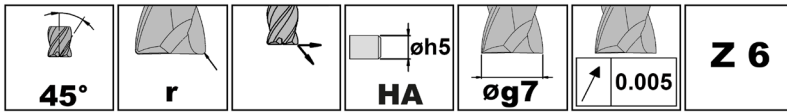

Bis Ø 3 mm vormontiert lieferbar für Toodle Schnelllaufspindel
Pre-assembled available up to Ø 3 mm for Toodle high-speed spindle

Bestellnummer Part number	d ₁	r	l ₂	d ₂	l ₁	Z	γ	TS3K
DSMR.6.020.020.20	2	0,2	4	6	57	6	40°	▲
DSMR.6.020.020.30	2	0,2	6	6	57	6	40°	▲
DSMR.6.020.020.40	2	0,2	8	6	57	6	40°	▲
DSMR.6.030.020.20	3	0,2	6	6	57	6	40°	▲
DSMR.6.030.020.30	3	0,2	9	6	57	6	40°	▲
DSMR.6.030.020.40	3	0,2	12	6	57	6	40°	▲
DSMR.6.030.050.20	3	0,5	6	6	57	6	40°	▲
DSMR.6.030.050.30	3	0,5	9	6	57	6	40°	▲
DSMR.6.030.050.40	3	0,5	12	6	57	6	40°	▲
DSMR.6.040.020.20	4	0,2	8	6	57	6	40°	▲
DSMR.6.040.020.30	4	0,2	12	6	57	6	40°	▲
DSMR.6.040.020.40	4	0,2	16	6	57	6	40°	▲
DSMR.6.040.050.20	4	0,5	8	6	57	6	40°	▲
DSMR.6.040.050.30	4	0,5	12	6	57	6	40°	▲
DSMR.6.040.050.40	4	0,5	20	6	57	6	40°	▲
DSMR.6.050.020.20	5	0,2	10	6	57	6	40°	▲
DSMR.6.050.020.30	5	0,2	15	6	57	6	40°	▲
DSMR.6.050.020.40	5	0,2	20	6	57	6	40°	▲
DSMR.6.050.050.20	5	0,5	10	6	57	6	40°	▲
DSMR.6.050.050.30	5	0,5	15	6	57	6	40°	▲
DSMR.6.050.050.40	5	0,5	20	6	57	6	40°	▲

▲ ab Lager / on stock Δ 4 Wochen / 4 weeks x auf Anfrage / upon request

● empfohlen / recommended

o bedingt einsetzbar / alternative recommendation

- nicht geeignet / not suitable

■ unbeschichtete HM-Sorten / uncoated grades

■ beschichtete HM-Sorten / coated grades

■ bestückt/Cermet / brazed/Cermet

Abmessungen in mm

Dimensions in mm

P	•
M	◦
K	◦
N	-
S	◦
H	◦

HM-Sorten
Carbide grades



Schnittdaten DSMR Ø 2,0 - 5,0 mm

Cutting Data DSM Ø 2,0 - 5,0 mm

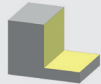
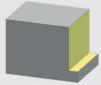

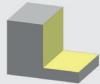
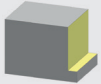
	 $vc = m/min$	 $vc = m/min$
P1.1	140	170
P1.2	140	170
P1.3	130	160
P2.1	120	140
P2.2	120	140
P2.3	120	140
P3.1	100	120
P3.2	90	110
M1.1	80	100
M2.1	60	70
M3.1	45	50

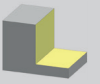
	 $vc = m/min$	 $vc = m/min$
K1.1	120	140
K1.2	100	120
K2.1	100	120
K2.2	80	100
K3.1	70	80
K3.2	60	70
S1	55	70
S2	40	50
S3	35	40
-	-	-
-	-	-

d_1	 α						
		f_z	a_e	a_p	f_z	a_e	a_p
2	3°	0,000	0,20	4,00	0,004	0,06	4,00
2	3°	0,000	0,20	4,00	0,004	0,06	4,00
2	3°	0,000	0,20	4,00	0,004	0,06	4,00
3	3°	0,004	0,30	6,00	0,011	0,09	6,00
3	3°	0,004	0,30	6,00	0,011	0,09	6,00
3	3°	0,004	0,30	6,00	0,011	0,09	6,00
3	3°	0,004	0,30	6,00	0,011	0,09	6,00
3	3°	0,004	0,30	6,00	0,011	0,09	6,00
3	3°	0,004	0,30	6,00	0,011	0,09	6,00
4	3°	0,008	0,40	8,00	0,017	0,12	8,00
4	3°	0,008	0,40	8,00	0,017	0,12	8,00
4	3°	0,008	0,40	8,00	0,017	0,12	8,00
4	3°	0,008	0,40	8,00	0,017	0,12	8,00
4	3°	0,008	0,40	8,00	0,017	0,12	8,00
4	3°	0,008	0,40	8,00	0,017	0,12	8,00
5	3°	0,012	0,50	10,00	0,024	0,15	10,00
5	3°	0,012	0,50	10,00	0,024	0,15	10,00
5	3°	0,012	0,50	10,00	0,024	0,15	10,00
5	3°	0,012	0,50	10,00	0,024	0,15	10,00
5	3°	0,012	0,50	10,00	0,024	0,15	10,00
5	3°	0,012	0,50	10,00	0,024	0,15	10,00

Abmessungen in mm
Dimensions in mm

B

Schaftfräser Mehrschneider, Radius

End Mill multiple fluted, radius



DSMR

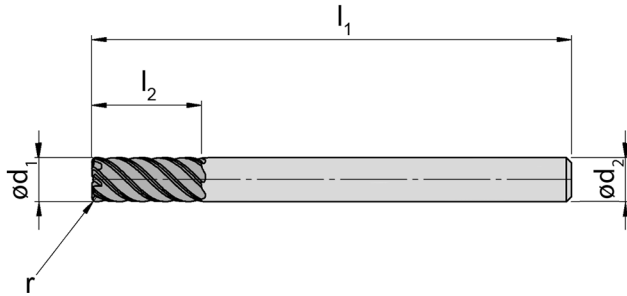
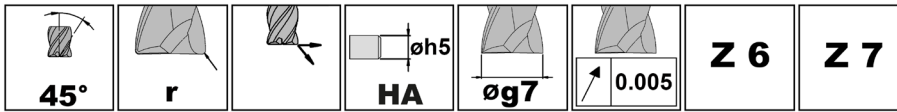

Bestellnummer Part number	d ₁	r	l ₂	d ₂	l ₁	Z	TS3K
DSMR.6.060.020.20	6	0,2	12	6	50	6	▲
DSMR.6.060.020.30	6	0,2	18	6	57	6	▲
DSMR.6.060.020.40	6	0,2	24	6	64	6	▲
DSMR.6.060.050.20	6	0,5	12	6	50	6	▲
DSMR.6.060.050.30	6	0,5	18	6	57	6	▲
DSMR.6.060.050.40	6	0,5	24	6	64	6	▲
DSMR.6.060.100.20	6	1,0	12	6	50	6	▲
DSMR.6.060.100.30	6	1,0	18	6	57	6	▲
DSMR.6.060.100.40	6	1,0	24	6	64	6	▲
DSMR.7.080.020.20	8	0,2	16	8	54	7	▲
DSMR.7.080.020.30	8	0,2	24	8	64	7	▲
DSMR.7.080.020.40	8	0,2	32	8	78	7	▲
DSMR.7.080.050.20	8	0,5	16	8	54	7	▲
DSMR.7.080.050.30	8	0,5	24	8	64	7	▲
DSMR.7.080.050.40	8	0,5	32	8	78	7	▲
DSMR.7.080.100.20	8	1,0	16	8	54	7	▲
DSMR.7.080.100.30	8	1,0	24	8	64	7	▲
DSMR.7.080.100.40	8	1,0	32	8	78	7	▲

▲ ab Lager / on stock Δ 4 Wochen / 4 weeks x auf Anfrage / upon request

● empfohlen / recommended

o bedingt einsetzbar / alternative recommendation

- nicht geeignet / not suitable

■ unbeschichtete HM-Sorten / uncoated grades

■ beschichtete HM-Sorten / coated grades

■ bestückt/Cermet / brazed/Cermet

Abmessungen in mm

Dimensions in mm

P	●
M	○
K	○
N	-
S	○
H	○

HM-Sorten
Carbide grades



Schnittdaten DSMR Ø 6,0 - 8,0 mm

Cutting Data DSMR Ø 6,0 - 8,0 mm

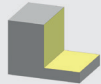
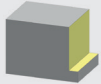

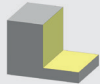
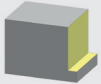
	 vc = m/min	 vc = m/min
P1.1	140	170
P1.2	140	170
P1.3	130	160
P2.1	120	140
P2.2	120	140
P2.3	120	140
P3.1	100	120
P3.2	90	110
M1.1	80	100
M2.1	60	70
M3.1	45	50

	 vc = m/min	 vc = m/min
K1.1	120	140
K1.2	100	120
K2.1	100	120
K2.2	80	100
K3.1	70	80
K3.2	60	70
S1	55	70
S2	40	50
S3	35	40
-	-	-
-	-	-

d ₁	 α						
		f _z	a _e	a _p	f _z	a _e	a _p
6	3°	0,016	0,60	12,00	0,030	0,18	12,00
6	3°	0,016	0,60	12,00	0,030	0,18	12,00
6	3°	0,016	0,60	12,00	0,030	0,18	12,00
6	3°	0,016	0,60	12,00	0,030	0,18	12,00
6	3°	0,016	0,60	12,00	0,030	0,18	12,00
6	3°	0,016	0,60	12,00	0,030	0,18	12,00
6	3°	0,016	0,60	12,00	0,030	0,18	12,00
6	3°	0,016	0,60	12,00	0,030	0,18	12,00
6	3°	0,016	0,60	12,00	0,030	0,18	12,00
6	3°	0,016	0,60	12,00	0,030	0,18	12,00
8	3°	0,019	0,80	16,00	0,038	0,24	16,00
8	3°	0,019	0,80	16,00	0,038	0,24	16,00
8	3°	0,019	0,80	16,00	0,038	0,24	16,00
8	3°	0,019	0,80	16,00	0,038	0,24	16,00
8	3°	0,019	0,80	16,00	0,038	0,24	16,00
8	3°	0,019	0,80	16,00	0,038	0,24	16,00
8	3°	0,019	0,80	16,00	0,038	0,24	16,00
8	3°	0,019	0,80	16,00	0,038	0,24	16,00
8	3°	0,019	0,80	16,00	0,038	0,24	16,00
8	3°	0,019	0,80	16,00	0,038	0,24	16,00

Abmessungen in mm
Dimensions in mm

B

Schaftfräser Mehrschneider, Radius

End Mill multiple fluted, radius



DSMR

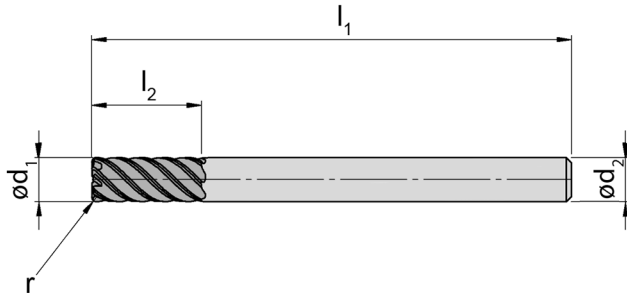
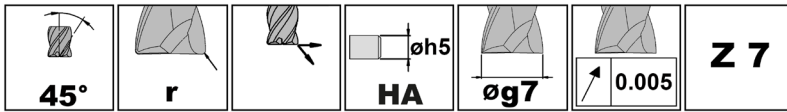

Bestellnummer Part number	d ₁	r	l ₂	d ₂	l ₁	Z	TS3K
DSMR.7.100.020.20	10	0,2	20	10	60	7	▲
DSMR.7.100.020.30	10	0,2	30	10	70	7	▲
DSMR.7.100.020.40	10	0,2	40	10	89	7	▲
DSMR.7.100.050.20	10	0,5	20	10	60	7	▲
DSMR.7.100.050.30	10	0,5	30	10	70	7	▲
DSMR.7.100.050.40	10	0,5	40	10	89	7	▲
DSMR.7.100.100.20	10	1,0	20	10	60	7	▲
DSMR.7.100.100.30	10	1,0	30	10	70	7	▲
DSMR.7.100.100.40	10	1,0	40	10	89	7	▲
DSMR.7.120.020.20	12	0,2	24	12	70	7	▲
DSMR.7.120.020.30	12	0,2	36	12	83	7	▲
DSMR.7.120.020.40	12	0,2	48	12	100	7	▲
DSMR.7.120.050.20	12	0,5	24	12	70	7	▲
DSMR.7.120.050.30	12	0,5	36	12	83	7	▲
DSMR.7.120.050.40	12	0,5	48	12	100	7	▲
DSMR.7.120.100.20	12	1,0	24	12	70	7	▲
DSMR.7.120.100.30	12	1,0	36	12	83	7	▲
DSMR.7.120.100.40	12	1,0	48	12	100	7	▲

▲ ab Lager / on stock Δ 4 Wochen / 4 weeks x auf Anfrage / upon request

● empfohlen / recommended

o bedingt einsetzbar / alternative recommendation

- nicht geeignet / not suitable

■ unbeschichtete HM-Sorten / uncoated grades

■ beschichtete HM-Sorten / coated grades

■ bestückt/Cermet / brazed/Cermet

Abmessungen in mm

Dimensions in mm

P	●
M	○
K	○
N	-
S	○
H	○

HM-Sorten
Carbide grades

Schnittdaten DSMR Ø 10,0 - 12,0 mm

Cutting Data DSMR Ø 10,0 - 12,0 mm

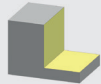
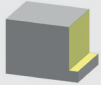

	 vc = m/min	 vc = m/min
P1.1	140	170
P1.2	140	170
P1.3	130	160
P2.1	120	140
P2.2	120	140
P2.3	120	140
P3.1	100	120
P3.2	90	110
M1.1	80	100
M2.1	60	70
M3.1	45	50

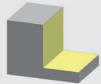
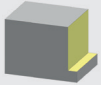
	 vc = m/min	 vc = m/min
K1.1	120	140
K1.2	100	120
K2.1	100	120
K2.2	80	100
K3.1	70	80
K3.2	60	70
S1	55	70
S2	40	50
S3	35	40
-	-	-
-	-	-

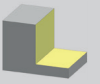
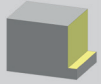
d ₁	 α						
		f _z	a _e	a _p	f _z	a _e	a _p
10	3°	0,027	1,00	20,00	0,050	0,30	20,00
10	3°	0,027	1,00	20,00	0,050	0,30	20,00
10	3°	0,027	1,00	20,00	0,050	0,30	20,00
10	3°	0,027	1,00	20,00	0,050	0,30	20,00
10	3°	0,027	1,00	20,00	0,050	0,30	20,00
10	3°	0,027	1,00	20,00	0,050	0,30	20,00
10	3°	0,027	1,00	20,00	0,050	0,30	20,00
10	3°	0,027	1,00	20,00	0,050	0,30	20,00
10	3°	0,027	1,00	20,00	0,050	0,30	20,00
10	3°	0,027	1,00	20,00	0,050	0,30	20,00
12	3°	0,035	1,20	24,00	0,063	0,36	24,00
12	3°	0,035	1,20	36,00	0,063	0,36	36,00
12	3°	0,035	1,20	48,00	0,063	0,36	48,00
12	3°	0,035	1,20	24,00	0,063	0,36	24,00
12	3°	0,035	1,20	36,00	0,063	0,36	36,00
12	3°	0,035	1,20	48,00	0,063	0,36	48,00
12	3°	0,035	1,20	24,00	0,063	0,36	24,00
12	3°	0,035	1,20	36,00	0,063	0,36	36,00
12	3°	0,035	1,20	48,00	0,063	0,36	48,00

Abmessungen in mm
Dimensions in mm

B

Schaftfräser Mehrschneider, Radius

End Mill multiple fluted, radius



DSMR

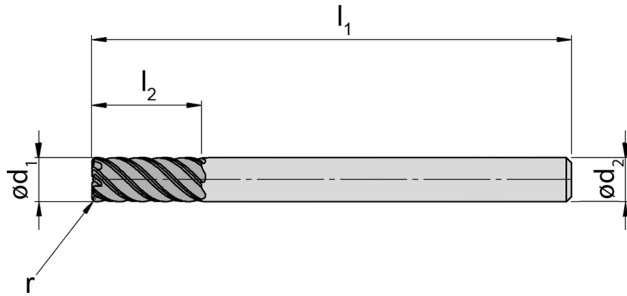
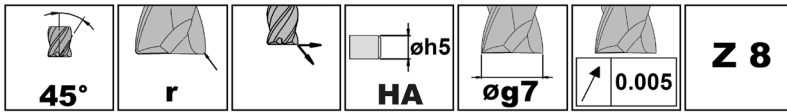

Bestellnummer Part number	d ₁	r	l ₂	d ₂	l ₁	Z	TS3K
DSMR.8.160.020.20	16	0,2	32	16	89	8	▲
DSMR.8.160.020.30	16	0,2	48	16	100	8	▲
DSMR.8.160.020.40	16	0,2	64	16	120	8	▲
DSMR.8.160.050.20	16	0,5	32	16	89	8	▲
DSMR.8.160.050.30	16	0,5	48	16	100	8	▲
DSMR.8.160.050.40	16	0,5	64	16	120	8	▲
DSMR.8.160.100.20	16	1,0	32	16	89	8	▲
DSMR.8.160.100.30	16	1,0	48	16	100	8	▲
DSMR.8.160.100.40	16	1,0	64	16	120	8	▲
DSMR.8.200.020.20	20	0,2	40	20	102	8	▲
DSMR.8.200.020.30	20	0,2	60	20	125	8	▲
DSMR.8.200.020.40	20	0,2	80	20	150	8	▲
DSMR.8.200.050.20	20	0,5	40	20	102	8	▲
DSMR.8.200.050.30	20	0,5	60	20	125	8	▲
DSMR.8.200.050.40	20	0,5	80	20	150	8	▲
DSMR.8.200.100.20	20	1,0	40	20	102	8	▲
DSMR.8.200.100.30	20	1,0	60	20	125	8	▲
DSMR.8.200.100.40	20	1,0	80	20	150	8	▲

▲ ab Lager / on stock Δ 4 Wochen / 4 weeks x auf Anfrage / upon request

● empfohlen / recommended

o bedingt einsetzbar / alternative recommendation

- nicht geeignet / not suitable

■ unbeschichtete HM-Sorten / uncoated grades

■ beschichtete HM-Sorten / coated grades

■ bestückt/Cermet / brazed/Cermet

Abmessungen in mm

Dimensions in mm

P	●
M	○
K	○
N	-
S	○
H	○

HM-Sorten
Carbide grades

Schnittdaten DSMR Ø 16,0 - 20,0 mm



Cutting Data DSMR Ø 16,0 - 20,0 mm

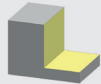
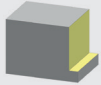

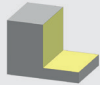
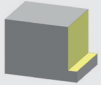
	 vc = m/min	 vc = m/min
P1.1	140	170
P1.2	140	170
P1.3	130	160
P2.1	120	140
P2.2	120	140
P2.3	120	140
P3.1	100	120
P3.2	90	110
M1.1	80	100
M2.1	60	70
M3.1	45	50

	 vc = m/min	 vc = m/min
K1.1	120	140
K1.2	100	120
K2.1	100	120
K2.2	80	100
K3.1	70	80
K3.2	60	70
S1	55	70
S2	40	50
S3	35	40
-	-	-
-	-	-

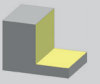
B

d ₁	 α						
		f _z	a _e	a _p	f _z	a _e	a _p
16	3°	0,047	1,60	32,00	0,085	0,48	32,00
16	3°	0,047	1,60	48,00	0,085	0,48	48,00
16	3°	0,047	1,60	64,00	0,085	0,48	64,00
16	3°	0,047	1,60	32,00	0,085	0,48	32,00
16	3°	0,047	1,60	48,00	0,085	0,48	48,00
16	3°	0,047	1,60	64,00	0,085	0,48	64,00
16	3°	0,047	1,60	32,00	0,085	0,48	32,00
16	3°	0,047	1,60	48,00	0,085	0,48	48,00
16	3°	0,047	1,60	64,00	0,085	0,48	64,00
20	3°	0,062	2,00	40,00	0,110	0,60	40,00
20	3°	0,062	2,00	60,00	0,110	0,60	60,00
20	3°	0,062	2,00	80,00	0,110	0,60	80,00
20	3°	0,062	2,00	40,00	0,110	0,60	40,00
20	3°	0,062	2,00	60,00	0,110	0,60	60,00
20	3°	0,062	2,00	80,00	0,110	0,60	80,00
20	3°	0,062	2,00	40,00	0,110	0,60	40,00
20	3°	0,062	2,00	60,00	0,110	0,60	60,00
20	3°	0,062	2,00	80,00	0,110	0,60	80,00

Abmessungen in mm
Dimensions in mm

Schruppfräser

Roughing End Mill



DSR

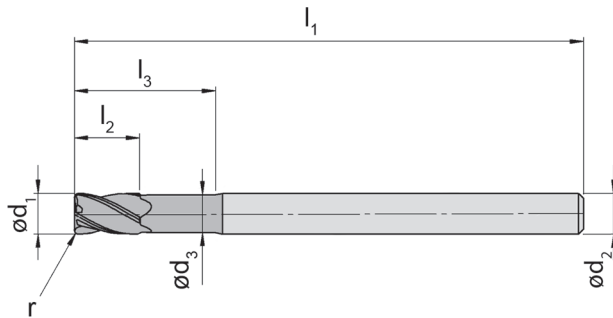
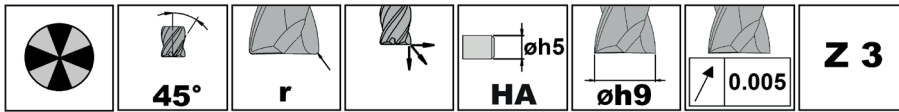

Bis Ø 3 mm vormontiert lieferbar für Toodle Schnelllaufspindel
Pre-assembled available up to Ø 3 mm for Toodle high-speed spindle

Bestellnummer Part number	d ₁	r	l ₂	l ₃	d ₃	d ₂	l ₁	Z	TS3K
DSR.3.020.38.03	2	0,2	3	10,5	1,9	3	38	3	▲
DSR.3.030.38.03	3	0,2	4	10,5	2,9	3	38	3	▲
DSR.3.040.50.06	4	0,2	5	12,5	3,8	6	50	3	▲
DSR.3.040.63.06	4	0,2	5	12,5	3,8	6	63	3	▲
DSR.3.050.50.06	5	0,2	6	14,5	4,7	6	50	3	▲
DSR.3.050.63.06	5	0,2	6	14,5	4,7	6	63	3	▲
DSR.3.060.63.06	6	0,3	7	16,5	5,6	6	63	3	▲
DSR.3.080.63.08	8	0,5	9	20,5	7,4	8	63	3	▲
DSR.3.100.69.10	10	0,5	12	25,5	9,4	10	69	3	▲
DSR.3.120.77.12	12	0,5	15	30,5	11,4	12	77	3	▲
DSR.3.160.88.16	16	0,5	18	38,0	15,4	16	88	3	▲

▲ ab Lager / on stock Δ 4 Wochen / 4 weeks x auf Anfrage / upon request

● empfohlen / recommended

o bedingt einsetzbar / alternative recommendation

- nicht geeignet / not suitable

■ unbeschichtete HM-Sorten / uncoated grades

■ beschichtete HM-Sorten / coated grades

■ bestückt/Cermet / brazed/Cermet

Abmessungen in mm

Dimensions in mm

P	●
M	○
K	○
N	-
S	○
H	○



HM-Sorten
Carbide grades

Schnittdaten DSMR Ø 2,0 - 16,0 mm

Cutting Data DSMR Ø 2,0 - 16,0 mm

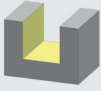
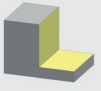

	 vc = m/min	 vc = m/min
P1.1	160	190
P1.2	160	190
P1.3	150	180
P2.1	140	170
P2.2	140	170
P2.3	140	170
P3.1	120	140
P3.2	110	130

d ₁							
		f _z	a _e	a _p	f _z	a _e	a _p
2	5°	0,007	2	2	0,014	0,50	2,00
3	5°	0,011	3	3	0,022	0,75	3,00
4	5°	0,015	4	4	0,030	1,00	4,00
4	5°	0,015	4	4	0,030	1,00	4,00
5	5°	0,019	5	5	0,038	1,25	5,00
5	5°	0,019	5	5	0,038	1,25	5,00
6	5°	0,023	6	6	0,046	1,50	6,00
8	5°	0,031	8	8	0,062	2,00	8,00
10	5°	0,039	10	10	0,078	2,50	10,00
12	5°	0,047	12	12	0,094	3,00	12,00
16	5°	0,063	16	16	0,126	4,00	16,00

Abmessungen in mm
Dimensions in mm

B

Schruppfräser

Roughing End Mill



DSF

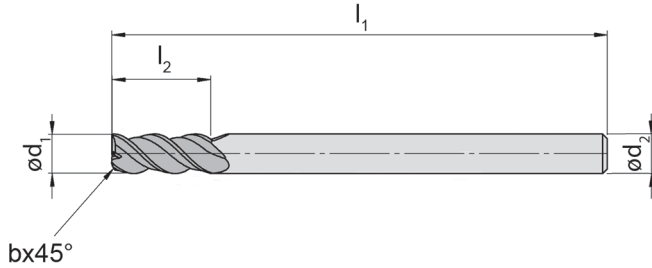
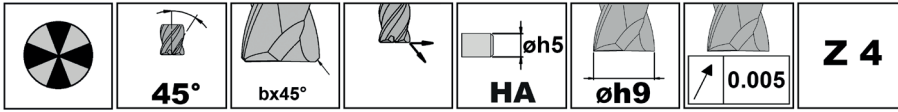

Bis Ø 3 mm vormontiert lieferbar für Toodle Schnelllaufspindel
Pre-assembled available up to Ø 3 mm for Toodle high-speed spindle

Bestellnummer Part number	d ₁	b	l ₂	d ₂	l ₁	Z	TS3K
DSF.3.020.38.03	2	0,10	8	3	38	3	▲
DSF.3.030.38.03	3	0,10	10	3	38	3	▲
DSF.3.040.50.04	4	0,10	12	4	50	3	▲
DSF.3.050.50.05	5	0,15	14	5	50	3	▲
DSF.3.060.63.06	6	0,15	16	6	63	3	▲
DSF.3.080.63.08	8	0,20	20	8	63	3	▲
DSF.3.100.69.10	10	0,20	22	10	69	3	▲
DSF.3.120.77.12	12	0,25	25	12	77	3	▲
DSF.3.160.88.16	16	-	35	16	88	3	▲

- ▲ ab Lager / on stock Δ 4 Wochen / 4 weeks x auf Anfrage / upon request
- empfohlen / recommended
- o bedingt einsetzbar / alternative recommendation
- nicht geeignet / not suitable
- unbeschichtete HM-Sorten / uncoated grades
- beschichtete HM-Sorten / coated grades
- bestückt/Cermet / brazed/Cermet

P	●
M	○
K	○
N	-
S	○
H	○

Abmessungen in mm
Dimensions in mm



HM-Sorten
Carbide grades

Schnittdaten DSF Ø 2,0 - 16,0 mm

Cutting Data DSF Ø 2,0 - 16,0 mm

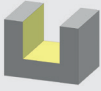
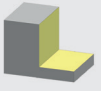

	 vc = m/min	 vc = m/min
P1.1	160	190
P1.2	160	190
P1.3	150	180
P2.1	140	170
P2.2	140	170
P2.3	140	170
P3.1	120	140
P3.2	110	130

d_1							
		f_z	a_e	a_p	f_z	a_e	a_p
2	5°	0,008	2	2	0,016	0,50	4,00
3	5°	0,012	3	3	0,024	0,75	6,00
4	5°	0,016	4	4	0,032	1,00	8,00
5	5°	0,020	5	5	0,040	1,25	10,00
6	5°	0,024	6	6	0,048	1,50	12,00
8	5°	0,032	8	8	0,064	2,00	16,00
10	5°	0,040	10	10	0,080	2,50	20,00
12	5°	0,048	12	12	0,096	3,00	24,00
16	5°	0,064	16	16	0,128	4,00	32,00

Abmessungen in mm
Dimensions in mm



Schruppfräser

Roughing End Mill



DSF

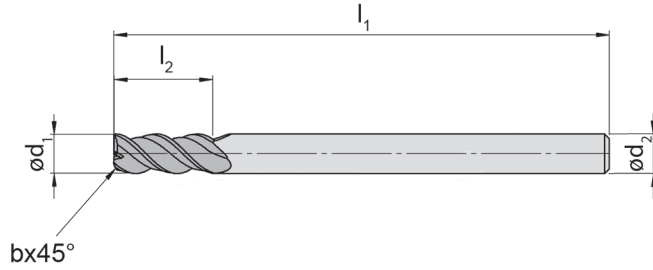
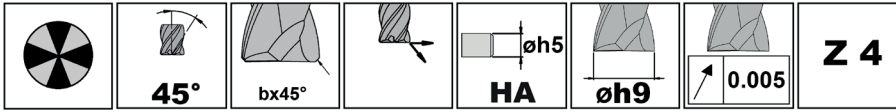

Bestellnummer Part number	d ₁	b	l ₂	d ₂	l ₁	Z	TS3K
DSF.4.040.50.04	4	0,10	12	4	50	4	▲
DSF.4.060.63.06	6	0,15	16	6	63	4	▲
DSF.4.080.63.08	8	0,20	20	8	63	4	▲
DSF.4.100.69.10	10	0,20	22	10	69	4	▲
DSF.4.120.77.12	12	0,25	25	12	77	4	▲
DSF.4.160.88.16	16	-	35	16	88	4	▲

▲ ab Lager / on stock Δ 4 Wochen / 4 weeks x auf Anfrage / upon request

● empfohlen / recommended

○ bedingt einsetzbar / alternative recommendation

- nicht geeignet / not suitable

□ unbeschichtete HM-Sorten / uncoated grades

■ beschichtete HM-Sorten / coated grades

■ bestückt/Cermet / brazed/Cermet

Abmessungen in mm

Dimensions in mm



P	●
M	○
K	○
N	-
S	○
H	○



HM-Sorten
Carbide grades

Schnittdaten DSF Ø 4,0 - 16,0 mm

Cutting Data DSF Ø 4,0 - 16,0 mm



	 vc = m/min	 vc = m/min
P1.1	160	190
P1.2	160	190
P1.3	150	180
P2.1	140	170
P2.2	140	170
P2.3	140	170
P3.1	120	140
P3.2	110	130

d ₁							
		f _z	a _e	a _p	f _z	a _e	a _p
4	4°	0,012	4	4	0,025	1,00	8,00
6	4°	0,020	6	6	0,041	1,50	12,00
8	4°	0,028	8	8	0,057	2,00	16,00
10	4°	0,036	10	10	0,073	2,50	20,00
12	4°	0,044	12	12	0,089	3,00	24,00
16	4°	0,060	16	16	0,121	4,00	32,00

Abmessungen in mm
Dimensions in mm



Schaftfräser Trochoidalfräsen

End Mill Trochoidal Milling



DSFT

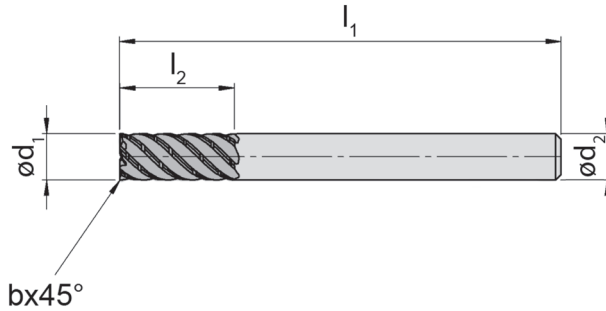
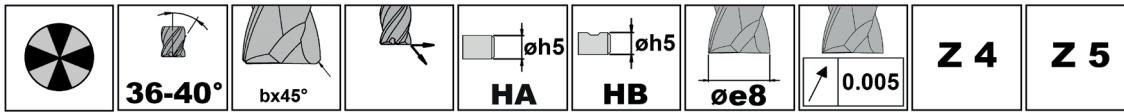

Bis Ø 3 mm vormontiert lieferbar für Toodle Schnelllaufspindel
Pre-assembled available up to Ø 3 mm for Toodle high-speed spindle

Bestellnummer Part number	d ₁	b	l ₂	d ₂	l ₁	Z	γ	Ausführung Type	TS3K
DSFT.4.020.010.20	2	0,10	5	6	50	4	40°	HA	▲
DSFT.4.020.010.30	2	0,10	7	6	50	4	40°	HA	▲
DSFT.4.020.010.40	2	0,10	9	6	54	4	40°	HA	▲
DSFT.4.030.010.20	3	0,10	7	6	50	4	40°	HA	▲
DSFT.4.030.010.30	3	0,10	10	6	54	4	40°	HA	▲
DSFT.4.030.010.40	3	0,10	13	6	57	4	40°	HA	▲
DSFT.4.040.010.20	4	0,10	9	6	50	4	40°	HA	▲
DSFT.4.040.010.30	4	0,10	13	6	57	4	40°	HA	▲
DSFT.4.040.010.40	4	0,10	17	6	60	4	40°	HA	▲
DSFT.4.050.010.20	5	0,10	11	6	50	4	40°	HA	▲
DSFT.4.050.010.30	5	0,10	16	6	57	4	40°	HA	▲
DSFT.4.050.010.40	5	0,10	21	6	64	4	40°	HA	▲
DSFT.5.060.010.20	6	0,10	13	6	57	5	-	HA	▲
DSFT.5.060.010.30	6	0,10	19	6	64	5	-	HA	▲
DSFT.5.060.010.40	6	0,10	25	6	64	5	-	HA	▲
DSFT.5.080.015.20	8	0,15	17	8	57	5	-	HA	▲
DSFT.5.080.015.30	8	0,15	25	8	64	5	-	HA	▲
DSFT.5.080.015.40	8	0,15	33	8	72	5	-	HA	▲
DSFT.5.100.020.20	10	0,20	21	10	64	5	-	HA	▲
DSFT.5.100.020.20B	10	0,20	21	10	64	5	-	HB	▲
DSFT.5.100.020.30	10	0,20	31	10	78	5	-	HA	▲
DSFT.5.100.020.30B	10	0,20	31	10	78	5	-	HB	▲
DSFT.5.100.020.40	10	0,20	41	10	89	5	-	HA	▲
DSFT.5.100.020.40B	10	0,20	41	10	89	5	-	HB	▲

▲ ab Lager / on stock Δ 4 Wochen / 4 weeks x auf Anfrage / upon request

● empfohlen / recommended

o bedingt einsetzbar / alternative recommendation

- nicht geeignet / not suitable

■ unbeschichtete HM-Sorten / uncoated grades

■ beschichtete HM-Sorten / coated grades

■ bestückt/Cermet / brazed/Cermet

Abmessungen in mm

Dimensions in mm

P	•
M	◦
K	◦
N	-
S	◦
H	◦



HM-Sorten
Carbide grades

Schnittdaten DSFT Ø 2,0 - 10,0 mm

Cutting Data DSF Ø 2,0 - 10,0 mm

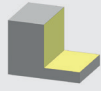
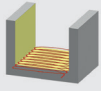

	 vc = m/min	 vc = m/min
P1.1	170	200
P1.2	170	200
P1.3	160	190
P2.1	160	190
P2.2	150	180
P2.3	150	180
P3.1	140	170
P3.2	140	170

d ₁	 α						
		f _z	a _e	a _p	f _z	a _e	a _p
2	3°	0,017	0,40	4,0	0,030	0,20	4,0
2	3°	0,016	0,36	6,0	0,029	0,18	6,0
2	3°	0,015	0,32	8,0	0,027	0,16	8,0
3	3°	0,029	0,60	6,0	0,048	0,30	6,0
3	3°	0,028	0,54	9,0	0,045	0,27	9,0
3	3°	0,026	0,48	12,0	0,043	0,24	12,0
4	3°	0,042	0,80	8,0	0,065	0,40	8,0
4	3°	0,040	0,72	12,0	0,062	0,36	12,0
4	3°	0,037	0,64	16,0	0,059	0,32	16,0
5	3°	0,054	1,00	10,0	0,083	0,50	10,0
5	3°	0,051	0,90	15,0	0,079	0,45	15,0
5	3°	0,048	0,80	20,0	0,074	0,40	20,0
6	3°	0,062	1,20	12,0	0,094	0,60	12,0
6	3°	0,059	1,08	18,0	0,089	0,54	18,0
6	3°	0,055	0,96	24,0	0,084	0,48	24,0
8	3°	0,087	1,60	16,0	0,129	0,80	16,0
8	3°	0,082	1,44	24,0	0,122	0,72	24,0
8	3°	0,078	1,28	32,0	0,115	0,64	32,0
10	3°	0,112	2,00	20,0	0,164	1,00	20,0
10	3°	0,106	1,80	30,0	0,156	0,90	30,0
10	3°	0,100	1,60	40,0	0,147	0,80	40,0
10	3°	0,112	2,00	20,0	0,164	1,00	20,0
10	3°	0,106	1,80	30,0	0,156	0,90	30,0
10	3°	0,100	1,60	40,0	0,147	0,80	40,0

Abmessungen in mm
Dimensions in mm



Schaftfräser Trochoidalfräsen

End Mill Trochoidal Milling



DSFT

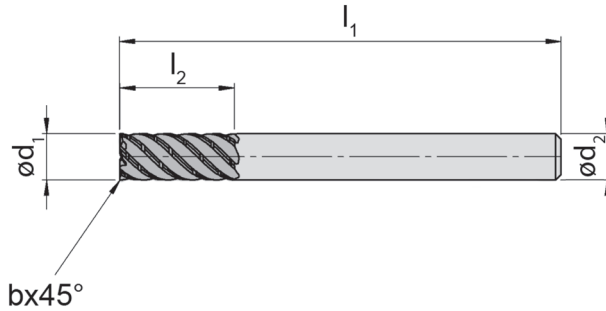
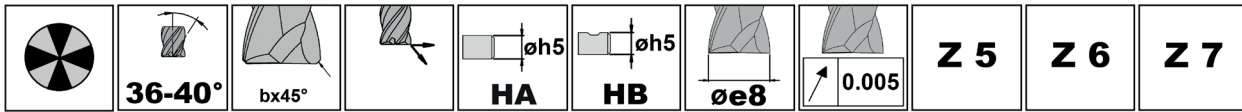

Bestellnummer Part number	d ₁	b	l ₂	d ₂	l ₁	Z	Ausführung Type	TS3K
DSFT.6.120.020.20	12	0,2	26	12	78	6	HA	▲
DSFT.6.120.020.20B	12	0,2	26	12	78	6	HB	▲
DSFT.6.120.020.30	12	0,2	38	12	100	6	HA	▲
DSFT.6.120.020.30B	12	0,2	38	12	100	6	HB	▲
DSFT.5.120.020.40	12	0,2	50	12	110	5	HA	▲
DSFT.5.120.020.40B	12	0,2	50	12	110	5	HB	▲
DSFT.6.160.030.20	16	0,3	34	16	100	6	HA	▲
DSFT.6.160.030.20B	16	0,3	34	16	100	6	HB	▲
DSFT.6.160.030.30	16	0,3	50	16	120	6	HA	▲
DSFT.6.160.030.30B	16	0,3	50	16	120	6	HB	▲
DSFT.5.160.030.40	16	0,3	66	16	130	5	HA	▲
DSFT.5.160.030.40B	16	0,3	66	16	130	5	HB	▲
DSFT.7.200.040.20	20	0,4	42	20	100	7	HA	▲
DSFT.7.200.040.20B	20	0,4	42	20	100	7	HB	▲
DSFT.7.200.040.30	20	0,4	62	20	120	7	HA	▲
DSFT.7.200.040.30B	20	0,4	62	20	120	7	HB	▲
DSFT.5.200.040.40	20	0,4	82	20	140	5	HA	▲
DSFT.5.200.040.40B	20	0,4	82	20	140	5	HB	▲

▲ ab Lager / on stock Δ 4 Wochen / 4 weeks x auf Anfrage / upon request

● empfohlen / recommended

o bedingt einsetzbar / alternative recommendation

- nicht geeignet / not suitable

■ unbeschichtete HM-Sorten / uncoated grades

■ beschichtete HM-Sorten / coated grades

■ bestückt/Cermet / brazed/Cermet

Abmessungen in mm

Dimensions in mm



TS3K	HM-Sorten Carbide grades
▲	P ●
▲	M ○
▲	K ○
▲	N -
▲	S ○
▲	H ○



HM-Sorten
Carbide grades

Schnittdaten DSFT Ø 12,0 - 20,0 mm

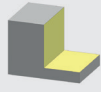
Cutting Data DSF Ø 12,0 - 20,0 mm



	 vc = m/min	 vc = m/min
P1.1	170	200
P1.2	170	200
P1.3	160	190
P2.1	160	190
P2.2	150	180
P2.3	150	180
P3.1	140	170
P3.2	140	170

d ₁	 α						
		f _z	a _e	a _p	f _z	a _e	a _p
12	3°	0,133	2,40	24,0	0,195	1,20	24,0
12	3°	0,127	2,16	36,0	0,185	1,08	36,0
12	3°	0,119	1,92	48,0	0,174	0,96	48,0
12	3°	0,133	2,40	24,0	0,195	1,20	24,0
12	3°	0,127	2,16	36,0	0,185	1,08	36,0
12	3°	0,119	1,92	48,0	0,174	0,96	48,0
16	3°	0,183	3,20	32,0	0,265	1,60	32,0
16	3°	0,174	2,88	48,0	0,252	1,44	48,0
16	3°	0,164	2,56	64,0	0,237	1,28	64,0
16	3°	0,183	3,20	32,0	0,265	1,60	32,0
16	3°	0,174	2,88	48,0	0,252	1,44	48,0
16	3°	0,164	2,56	64,0	0,237	1,28	64,0
20	3°	0,231	4,00	40,0	0,332	2,00	40,0
20	3°	0,219	3,60	60,0	0,315	1,80	60,0
20	3°	0,206	3,20	80,0	0,297	1,60	80,0
20	3°	0,231	4,00	40,0	0,332	2,00	40,0
20	3°	0,219	3,60	60,0	0,315	1,80	60,0
20	3°	0,206	3,20	80,0	0,297	1,60	80,0

Abmessungen in mm
Dimensions in mm



DSH

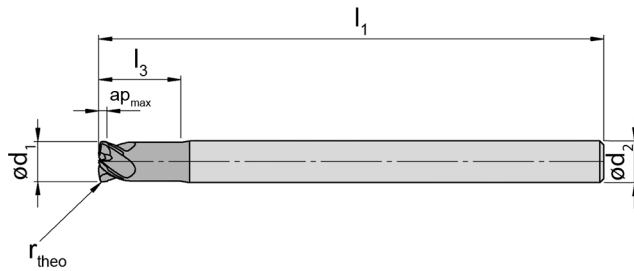
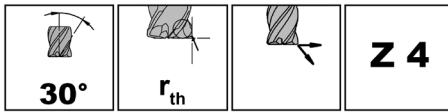

Bis Ø 3 mm vormontiert lieferbar für Toodle Schnelllaufspindel
Pre-assembled available up to Ø 3 mm for Toodle high-speed spindle

Bestellnummer Part number	d ₁	r _{theo}	l ₃	d ₂	l ₁	Z	Ausführung Type	a _p	TS3K
DSH.4.020.035.020	2	0,35	4	6	50	4	HA	0,20	▲
DSH.4.020.035.030	2	0,35	6	6	50	4	HA	0,20	▲
DSH.4.030.050.020	3	0,50	6	6	50	4	HA	0,30	▲
DSH.4.030.050.030	3	0,50	9	6	50	4	HA	0,30	▲
DSH.4.040.070.020	4	0,70	8	6	50	4	HA	0,35	▲
DSH.4.040.070.030	4	0,70	12	6	57	4	HA	0,35	▲
DSH.4.050.080.020	5	0,80	10	6	50	4	HA	0,38	▲
DSH.4.050.080.030	5	0,80	15	6	57	4	HA	0,38	▲
DSH.4.060.080.020	6	0,80	12	6	50	4	HA	0,40	▲
DSH.4.060.080.030	6	0,80	18	6	64	4	HA	0,40	▲
DSH.4.080.140.020	8	1,40	16	8	60	4	HA	0,50	▲
DSH.4.080.140.030	8	1,40	24	8	63	4	HA	0,50	▲
DSH.4.100.200.020	10	2,00	20	10	70	4	HA	0,70	▲
DSH.4.100.200.030	10	2,00	30	10	78	4	HA	0,70	▲
DSH.4.120.210.020	12	2,10	24	12	78	4	HA	0,80	▲
DSH.4.120.210.030	12	2,10	36	12	89	4	HA	0,80	▲
DSH.4.160.280.020	16	2,80	32	16	89	4	HA	1,00	▲
DSH.4.160.280.030	16	2,80	48	16	100	4	HA	1,00	▲

▲ ab Lager / on stock Δ 4 Wochen / 4 weeks x auf Anfrage / upon request

● empfohlen / recommended

o bedingt einsetzbar / alternative recommendation

- nicht geeignet / not suitable

■ unbeschichtete HM-Sorten / uncoated grades

■ beschichtete HM-Sorten / coated grades

■ bestückt/Cermet / brazed/Cermet

Abmessungen in mm

Dimensions in mm



P	●
M	○
K	○
N	-
S	○
H	○



HM-Sorten
Carbide grades

Schnittdaten DSH Ø 2,0 - 16,0 mm

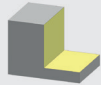

Cutting Data DSH Ø 2,0 - 16,0 mm

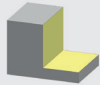

	 vc = m/min	 vc = m/min
P1.1	170	200
P1.2	170	200
P1.3	160	190
P2.1	160	190
P2.2	150	180
P2.3	150	180
P3.1	140	170
P3.2	140	170
M1.1	120	140
M2.1	110	130
M3.1	100	120

	 vc = m/min	 vc = m/min
K1.1	140	170
K1.2	140	170
K2.1	130	160
K2.2	130	160
K3.1	120	140
K3.2	120	140
S1	100	120
S2	80	100
S3	70	80
-	-	-
-	-	-

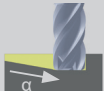

d_1	 α						
		f_z	a_e	a_p	f_z	a_e	a_p
2	3°	0,070	2	0,15	0,081	1,50	0,17
2	3°	0,070	2	0,14	0,081	1,50	0,15
3	3°	0,110	3	0,20	0,128	2,25	0,23
3	3°	0,110	3	0,20	0,128	2,25	0,23
4	3°	0,150	4	0,24	0,174	3,00	0,27
4	3°	0,150	4	0,24	0,174	3,00	0,27
5	3°	0,190	5	0,26	0,220	3,75	0,29
5	3°	0,190	5	0,26	0,220	3,75	0,29
6	3°	0,230	6	0,27	0,266	4,50	0,31
6	3°	0,230	6	0,27	0,266	4,50	0,31
8	3°	0,310	8	0,34	0,359	6,00	0,38
8	3°	0,310	8	0,34	0,359	6,00	0,38
10	3°	0,390	10	0,47	0,451	7,50	0,54
10	3°	0,390	10	0,47	0,451	7,50	0,54
12	3°	0,470	12	0,54	0,543	9,00	0,61
12	3°	0,470	12	0,54	0,543	9,00	0,61
16	3°	0,630	16	0,68	0,728	12,00	0,77
16	3°	0,630	16	0,68	0,728	12,00	0,77

Abmessungen in mm
Dimensions in mm

Schafffräser Fasen

End Mill Chamfering



DSFF

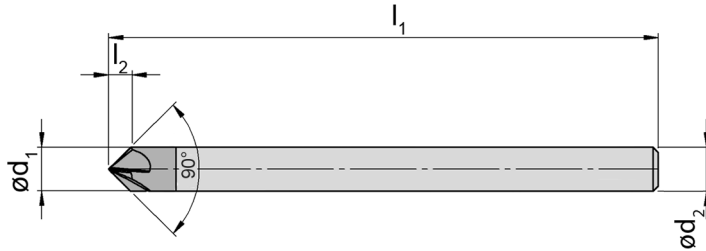
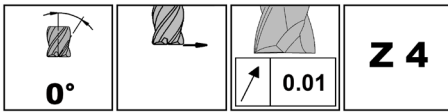

Bestellnummer Part number	d ₁	l ₂	d ₂	l ₁	Z	TS3K
DSFF.4.04.50.04.45	4	2	4	50	4	▲
DSFF.4.06.63.06.45	6	3	6	63	4	▲
DSFF.4.08.63.08.45	8	4	8	63	4	▲
DSFF.4.10.69.10.45	10	5	10	69	4	▲
DSFF.4.12.77.12.45	12	6	12	77	4	▲

▲ ab Lager / on stock Δ 4 Wochen / 4 weeks x auf Anfrage / upon request

● empfohlen / recommended

○ bedingt einsetzbar / alternative recommendation

- nicht geeignet / not suitable

□ unbeschichtete HM-Sorten / uncoated grades

■ beschichtete HM-Sorten / coated grades

■ bestückt/Cermet / brazed/Cermet

Abmessungen in mm

Dimensions in mm

P	●
M	○
K	○
N	-
S	○
H	○

HM-Sorten
Carbide grades

B



Schnittdaten DSFF Ø 2,0 - 6,0 mm

Cutting Data DSFF Ø 2,0 - 6,0 mm

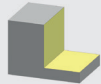
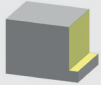

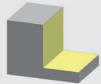
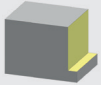
	 vc = m/min	 vc = m/min
P1.1	140	170
P1.2	140	170
P1.3	130	160
P2.1	120	140
P2.2	120	140
P2.3	120	140
P3.1	100	120
P3.2	90	110
M1.1	80	100
M2.1	60	70
M3.1	45	50

	 vc = m/min	 vc = m/min
K1.1	120	140
K1.2	100	120
K2.1	100	120
K2.2	80	100
K3.1	70	80
K3.2	60	70
S1	55	70
S2	40	50
S3	35	40
-	-	-
-	-	-

d_1						
	f_z	a_e	a_p	f_z	a_e	a_p
2	0,030	0,60	0,60	0,050	0,10	0,10
2	0,040	0,75	0,75	0,060	0,15	0,15
3	0,450	1,00	1,00	0,070	0,20	0,20
3	0,050	1,25	1,25	0,080	0,25	0,25
4	0,060	1,50	1,50	0,080	0,30	0,30

Abmessungen in mm
Dimensions in mm



Vollhartmetall-Schaftfräser

Solid Carbide End Mills



B



DSKMH Schaftfräser Vollradius Mikro
Ball Nose End Mill Micro

Ø 0,2 – Ø 3,0

Z 2

B72 – B77



DSK.2 Schaftfräser Vollradius
Ball nose End Mill

Ø 4,0 – Ø 16,0

Z 2

B78 – B79



DSK.4 Schaftfräser Vollradius
Ball nose End Mill

Ø 4,0 – Ø 12,0

Z 4

B80 – B81



DSTMH Torusfräser Mikro
Torus End Mill Micro

Ø 0,1 – Ø 3,0

Z 2

B82 – B89

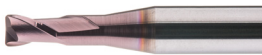

DSTH.2 Torusfräser
Torus End Mill

Ø 4,0 – Ø 12,0

Z 2

B90 – B101



DSTH.4 Torusfräser
Torus End Mill

Ø 4,0 – Ø 12,0

Z 4

B102 – B111



DSMH Schaftfräser Mehrschneider
End Mill multiple fluted

Ø 3,0 – Ø 12,0

Z 6

B112 – B113



DSMH Schaftfräser Mehrschneider
End Mill multiple fluted

Ø 3,0 – Ø 12,0

Z 6

B114 – B115

DS

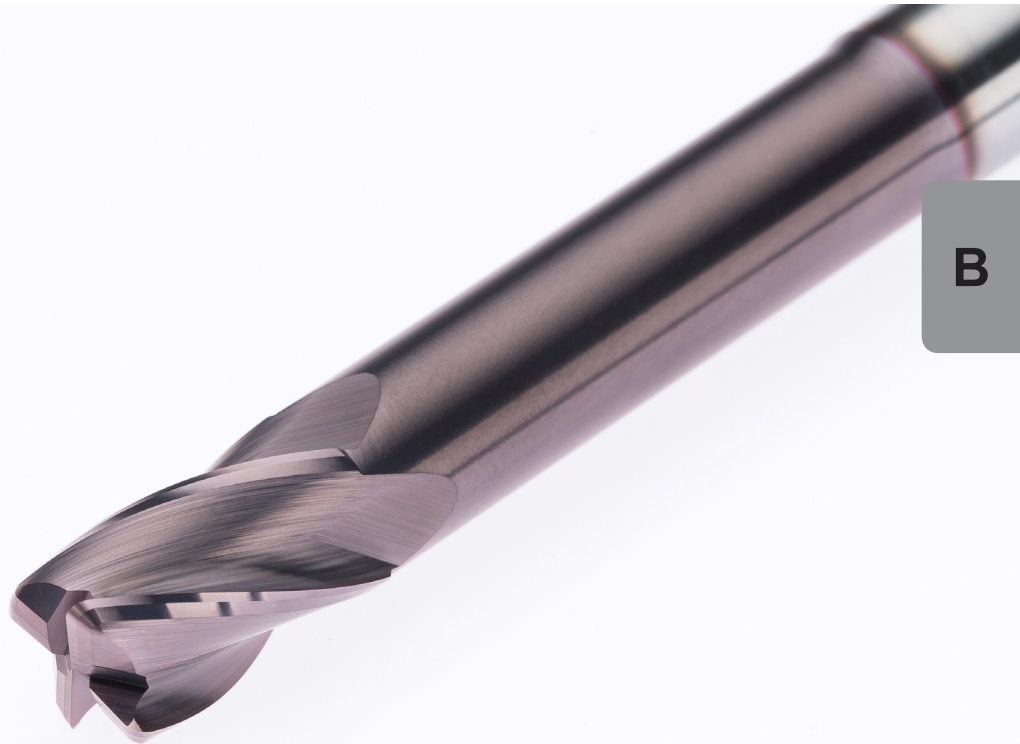

abgestimmt für:

- gehärtete Stähle

designed for:

- hardened Steels

DSKMH

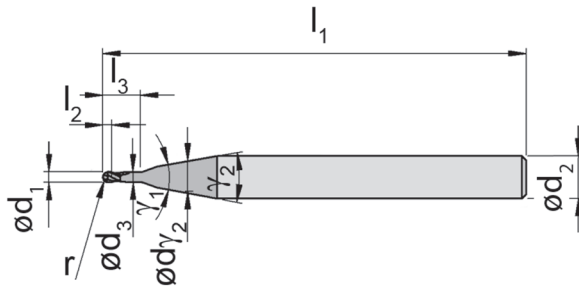
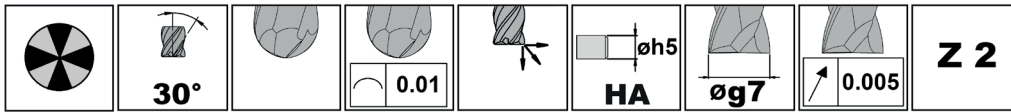

B

Bestellnummer Part number	d ₁	r	l ₂	l ₃	d ₃	d ₂	l ₁	Z	γ ₁	γ ₂	d _{γ₂}	TS3E
DSKMH.020.015	0,2	0,10	0,30	-	-	4	50	2	20°	-°	-	▲
DSKMH.020.030	0,2	0,10	0,30	0,6	0,18	4	50	2	40°	20°	1,5	▲
DSKMH.020.050	0,2	0,10	0,30	1,0	0,18	4	50	2	40°	20°	1,5	▲
DSKMH.030.015	0,3	0,15	0,45	-	-	4	50	2	20°	-°	-	▲
DSKMH.030.030	0,3	0,15	0,45	0,9	0,28	4	50	2	40°	20°	1,5	▲
DSKMH.030.050	0,3	0,15	0,45	1,5	0,28	4	50	2	40°	20°	1,5	▲
DSKMH.040.015	0,4	0,20	0,60	-	-	4	50	2	20°	-°	-	▲
DSKMH.040.030	0,4	0,20	0,60	1,2	0,38	4	50	2	40°	20°	1,5	▲
DSKMH.040.050	0,4	0,20	0,60	2,0	0,38	4	50	2	40°	20°	1,5	▲
DSKMH.050.015	0,5	0,25	0,75	-	-	4	50	2	20°	-°	-	▲
DSKMH.050.030	0,5	0,25	0,75	1,5	0,47	4	50	2	40°	20°	1,5	▲
DSKMH.050.050	0,5	0,25	0,75	2,5	0,47	4	50	2	40°	20°	1,5	▲
DSKMH.050.070	0,5	0,25	0,75	3,5	0,47	4	50	2	40°	20°	1,5	▲
DSKMH.060.015	0,6	0,30	0,90	-	-	4	50	2	20°	-°	-	▲
DSKMH.060.030	0,6	0,30	0,90	1,8	0,56	4	50	2	40°	20°	1,5	▲
DSKMH.060.050	0,6	0,30	0,90	3,0	0,56	4	50	2	40°	20°	1,5	▲
DSKMH.060.070	0,6	0,30	0,90	4,2	0,56	4	50	2	40°	20°	1,5	▲
DSKMH.080.015	0,8	0,40	-	1,2	-	4	50	2	20°	-°	-	▲
DSKMH.080.030	0,8	0,40	1,20	2,4	0,75	4	50	2	40°	20°	1,5	▲
DSKMH.080.050	0,8	0,40	1,20	4,0	0,75	4	50	2	40°	20°	1,5	▲
DSKMH.080.070	0,8	0,40	1,20	5,6	0,75	4	50	2	40°	20°	1,5	▲

▲ ab Lager / on stock Δ 4 Wochen / 4 weeks x auf Anfrage / upon request

● empfohlen / recommended

o bedingt einsetzbar / alternative recommendation

- nicht geeignet / not suitable

■ unbeschichtete HM-Sorten / uncoated grades

■ beschichtete HM-Sorten / coated grades

■ bestückt/Cermet / brazed/Cermet

Abmessungen in mm

Dimensions in mm

P	-
M	-
K	-
N	-
S	-
H	•



HM-Sorten
Carbide grades

Schnittdaten DSKMH Ø 0,2 - 0,8 mm



Cutting Data DSKMH Ø 0,2 - 0,8 mm





Konventionelles Fräsen / Conventional milling

		
	vc = m/min	vc = m/min
H1.1	120	150
H1.2	100	130
H1.3	80	100
H1.4	70	90

HSC Fräsen / HSC milling

		
	vc = m/min	vc = m/min
H1.1	180	220
H1.2	160	190
H1.3	140	170
H1.4	120	140

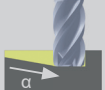
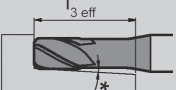
B

d ₁												
		0°	0,5°	1°	2°	3°	f _z	a _e	a _p	f _z	a _e	a _p
0,2	5°	0,30	0,50	0,50	0,60	0,60	0,004	0,04	0,03	0,008	0,01	0,02
0,2	4°	0,60	0,70	0,70	0,80	0,90	0,004	0,04	0,03	0,008	0,01	0,02
0,2	3°	1,00	0,90	0,90	1,00	1,20	0,004	0,04	0,02	0,007	0,01	0,02
0,3	5°	0,45	1,10	1,10	1,20	1,50	0,005	0,06	0,05	0,010	0,02	0,03
0,3	4°	0,90	1,30	1,30	1,40	1,80	0,005	0,06	0,04	0,010	0,02	0,03
0,3	3°	1,50	1,50	1,50	1,60	2,10	0,005	0,06	0,03	0,009	0,02	0,02
0,4	5°	0,60	1,70	1,70	1,80	2,40	0,007	0,08	0,06	0,012	0,02	0,04
0,4	4°	1,20	1,90	1,90	2,00	2,70	0,007	0,08	0,05	0,012	0,02	0,04
0,4	3°	2,00	2,10	2,10	2,20	3,00	0,006	0,08	0,04	0,011	0,02	0,03
0,5	5°	0,75	2,30	2,30	2,40	3,30	0,008	0,10	0,08	0,014	0,03	0,05
0,5	4°	1,50	2,50	2,50	2,60	3,60	0,008	0,10	0,07	0,014	0,03	0,05
0,5	3°	2,50	2,70	2,70	2,80	3,90	0,007	0,10	0,06	0,013	0,03	0,04
0,5	2°	3,50	2,90	2,90	3,00	4,20	0,006	0,10	0,05	0,011	0,03	0,03
0,6	5°	0,90	3,10	3,10	3,20	4,50	0,009	0,12	0,09	0,016	0,03	0,06
0,6	4°	1,80	3,30	3,30	3,40	4,80	0,009	0,12	0,08	0,016	0,03	0,06
0,6	3°	3,00	3,50	3,50	3,60	5,10	0,008	0,12	0,07	0,014	0,03	0,05
0,6	2°	4,20	3,70	3,70	3,80	5,40	0,007	0,12	0,05	0,013	0,03	0,04
0,8	5°	1,20	3,90	3,90	4,00	5,70	0,011	0,16	0,12	0,020	0,04	0,08
0,8	4°	2,40	4,10	4,10	4,20	6,00	0,011	0,16	0,10	0,020	0,04	0,08
0,8	3°	4,00	4,30	4,30	4,40	6,30	0,010	0,16	0,09	0,018	0,04	0,06
0,8	2°	5,60	4,50	4,50	4,60	6,60	0,009	0,16	0,07	0,016	0,04	0,05

Abmessungen in mm
Dimensions in mm

Mikrofräser Vollradius

Micro End Mill Ballnose



DSKMH

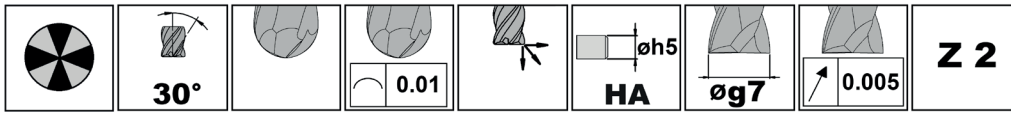

B

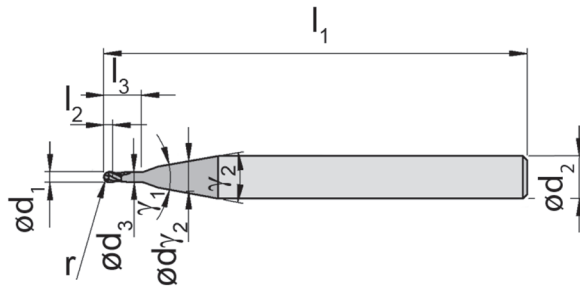

Bis Ø 3 mm vormontiert lieferbar für Toodle Schnelllaufspindel
Pre-assembled available up to Ø 3 mm for Toodle high-speed spindle

Bestellnummer Part number	d ₁	r	l ₂	l ₃	d ₃	d ₂	l ₁	Z	γ ₁	γ ₂	d _{v2}	TS3E
DSKMH.100.015	1,0	0,50	1,50	-	-	4	50	2	20°	-°	-	▲
DSKMH.100.030	1,0	0,50	1,50	3,0	0,95	4	50	2	40°	20°	2,0	▲
DSKMH.100.050	1,0	0,50	1,50	5,0	0,95	4	50	2	40°	20°	2,0	▲
DSKMH.100.070	1,0	0,50	1,50	7,0	0,95	4	50	2	40°	20°	2,0	▲
DSKMH.120.015	1,2	0,60	1,80	-	-	4	50	2	20°	-°	-	▲
DSKMH.120.030	1,2	0,60	1,80	3,6	1,15	4	50	2	40°	20°	2,0	▲
DSKMH.120.050	1,2	0,60	1,80	6,0	1,15	4	50	2	40°	20°	2,0	▲
DSKMH.120.070	1,2	0,60	1,80	8,4	1,15	4	50	2	40°	20°	2,0	▲
DSKMH.150.015	1,5	0,75	2,25	-	-	4	50	2	20°	-°	-	▲
DSKMH.150.030	1,5	0,75	2,25	4,5	1,45	4	50	2	40°	20°	2,5	▲
DSKMH.150.050	1,5	0,75	2,25	7,5	1,45	4	50	2	40°	20°	2,5	▲
DSKMH.150.070	1,5	0,75	2,25	10,5	1,45	4	50	2	40°	20°	2,5	▲
DSKMH.200.015	2,0	1,00	3,00	-	-	4	50	2	20°	-°	-	▲
DSKMH.200.030	2,0	1,00	3,00	6,0	1,90	4	50	2	40°	20°	3,0	▲
DSKMH.200.050	2,0	1,00	3,00	10,0	1,90	4	50	2	40°	20°	3,0	▲
DSKMH.200.070	2,0	1,00	3,00	14,0	1,90	4	50	2	40°	20°	3,0	▲
DSKMH.250.015	2,5	1,25	3,75	-	-	4	50	2	20°	-°	-	▲
DSKMH.250.030	2,5	1,25	3,75	7,5	2,40	4	50	2	40°	20°	3,5	▲
DSKMH.250.050	2,5	1,25	3,75	12,5	2,40	4	50	2	40°	20°	3,5	▲
DSKMH.250.070	2,5	1,25	3,75	17,5	2,40	4	50	2	40°	20°	3,5	▲
DSKMH.300.015	3,0	1,50	4,50	-	-	4	50	2	20°	-°	-	▲
DSKMH.300.030	3,0	1,50	4,50	9,0	2,90	4	50	2	40°	20°	3,5	▲
DSKMH.300.050	3,0	1,50	4,50	15,0	2,90	4	50	2	40°	20°	3,5	▲
DSKMH.300.070	3,0	1,50	4,50	21,0	2,90	4	60	2	40°	20°	3,5	▲

▲ ab Lager / on stock Δ 4 Wochen / 4 weeks x auf Anfrage / upon request

● empfohlen / recommended

o bedingt einsetzbar / alternative recommendation

- nicht geeignet / not suitable

■ unbeschichtete HM-Sorten / uncoated grades

■ beschichtete HM-Sorten / coated grades

■ bestückt/Cermet / brazed/Cermet

Abmessungen in mm

Dimensions in mm

P	-
M	-
K	-
N	-
S	-
H	•



HM-Sorten
Carbide grades

Schnittdaten DSKMH Ø 1,0 - 3,0 mm



Cutting Data DST Ø 0,2 - 0,8 mm

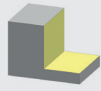

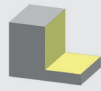

Konventionelles Fräsen / Conventional milling

		
	vc = m/min	vc = m/min
H1.1	120	150
H1.2	100	130
H1.3	80	100
H1.4	70	90

HSC Fräsen / HSC milling

		
	vc = m/min	vc = m/min
H1.1	180	220
H1.2	160	190
H1.3	140	170
H1.4	120	140

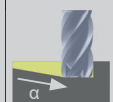
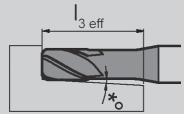
B

d ₁												
		0°	0,5°	1°	2°	3°	f _z	a _e	a _p	f _z	a _e	a _p
1,0	5°	1,50	4,70	4,70	4,80	6,90	0,013	0,20	0,15	0,024	0,05	0,10
1,0	4°	3,00	4,90	4,90	5,00	7,20	0,013	0,20	0,13	0,024	0,05	0,10
1,0	3°	5,00	5,10	5,10	5,20	7,50	0,012	0,20	0,11	0,021	0,05	0,08
1,0	2°	7,00	5,30	5,30	5,40	7,80	0,011	0,20	0,09	0,019	0,05	0,06
1,2	5°	1,80	2,00	2,10	2,30	2,60	0,016	0,24	0,18	0,028	0,06	0,12
1,2	4°	3,60	3,90	4,00	4,20	4,40	0,016	0,24	0,16	0,028	0,06	0,12
1,2	3°	6,00	6,30	6,50	6,80	7,20	0,014	0,24	0,13	0,025	0,06	0,10
1,2	2°	8,40	8,80	9,00	9,50	10,00	0,012	0,24	0,11	0,022	0,06	0,07
1,5	5°	2,25	2,50	2,60	2,80	3,10	0,019	0,30	0,23	0,033	0,08	0,15
1,5	4°	4,50	4,80	4,90	5,10	5,40	0,019	0,30	0,20	0,033	0,08	0,15
1,5	3°	7,50	7,90	8,10	8,50	8,90	0,017	0,30	0,17	0,030	0,08	0,12
1,5	2°	10,50	11,00	11,20	11,80	12,90	0,015	0,30	0,14	0,027	0,08	0,09
2,0	5°	3,00	3,30	3,40	3,70	4,10	0,024	0,40	0,30	0,043	0,10	0,20
2,0	4°	6,00	6,40	6,50	6,80	7,20	0,024	0,40	0,26	0,043	0,10	0,20
2,0	3°	10,00	10,50	10,70	11,30	12,10	0,022	0,40	0,22	0,039	0,10	0,16
2,0	2°	14,00	14,60	14,90	14,70	17,80	0,020	0,40	0,18	0,034	0,10	0,12
2,5	5°	3,75	4,00	4,20	4,60	5,10	0,030	0,50	0,38	0,053	0,13	0,25
2,5	4°	7,50	7,90	8,10	8,50	8,90	0,030	0,50	0,33	0,053	0,13	0,25
2,5	3°	12,50	13,10	13,40	14,00	15,60	0,027	0,50	0,28	0,048	0,13	0,20
2,5	2°	17,50	18,20	18,60	20,00	∞	0,024	0,50	0,23	0,042	0,13	0,15
3,0	5°	4,50	4,80	5,00	5,50	6,00	0,036	0,60	0,45	0,063	0,15	0,30
3,0	4°	9,00	9,40	9,70	10,30	∞	0,036	0,60	0,39	0,063	0,15	0,30
3,0	3°	15,00	15,60	16,00	∞	∞	0,032	0,60	0,33	0,056	0,15	0,24
3,0	2°	21,00	21,80	22,60	∞	∞	0,029	0,60	0,27	0,050	0,15	0,18

Abmessungen in mm
Dimensions in mm

Schaftfräser Vollradius

Ball Nose End Mill



DSKH

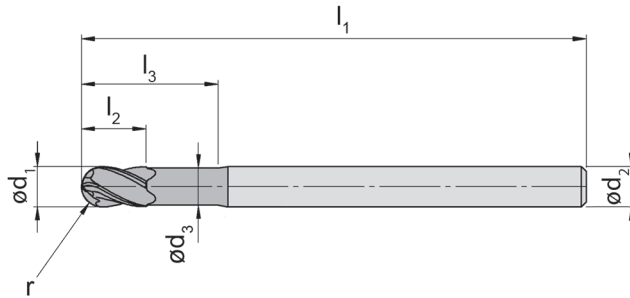

B

Bestellnummer Part number	d ₁	r	l ₂	l ₃	d ₃	d ₂	l ₁	Z	γ	TS3E
DSKH.2.040.015	4	2,0	6,0	6,0	-	6	64	2	20°	▲
DSKH.2.040.030	4	2,0	6,0	12,0	3,8	6	64	2	20°	▲
DSKH.2.040.050	4	2,0	6,0	20,0	3,8	6	64	2	20°	▲
DSKH.2.040.070	4	2,0	6,0	28,0	3,8	6	64	2	20°	▲
DSKH.2.050.015	5	2,5	7,5	7,5	-	6	64	2	20°	▲
DSKH.2.050.030	5	2,5	7,5	15,0	4,7	6	64	2	20°	▲
DSKH.2.050.050	5	2,5	7,5	25,0	4,7	6	64	2	20°	▲
DSKH.2.050.070	5	2,5	7,5	35,0	4,7	6	78	2	20°	▲
DSKH.2.060.015	6	3,0	9,0	9,0	-	6	64	2	-°	▲
DSKH.2.060.030	6	3,0	9,0	18,0	5,7	6	64	2	-°	▲
DSKH.2.060.050	6	3,0	9,0	30,0	5,7	6	78	2	-°	▲
DSKH.2.060.070	6	3,0	9,0	42,0	5,7	6	78	2	-°	▲
DSKH.2.080.015	8	4,0	12,0	12,0	-	8	64	2	-°	▲
DSKH.2.080.030	8	4,0	12,0	24,0	7,6	8	64	2	-°	▲
DSKH.2.080.050	8	4,0	12,0	40,0	7,6	8	78	2	-°	▲
DSKH.2.080.070	8	4,0	12,0	56,0	7,6	8	100	2	-°	▲
DSKH.2.100.015	10	5,0	15,0	15,0	-	10	78	2	-°	▲
DSKH.2.100.030	10	5,0	15,0	30,0	9,6	10	78	2	-°	▲
DSKH.2.100.050	10	5,0	15,0	50,0	9,6	10	100	2	-°	▲
DSKH.2.100.070	10	5,0	15,0	70,0	9,6	10	120	2	-°	▲
DSKH.2.120.015	12	6,0	18,0	18,0	-	12	78	2	-°	▲
DSKH.2.120.030	12	6,0	18,0	36,0	11,6	12	100	2	-°	▲
DSKH.2.120.050	12	6,0	18,0	60,0	11,6	12	120	2	-°	▲
DSKH.2.120.070	12	6,0	18,0	84,0	11,6	12	140	2	-°	▲

▲ ab Lager / on stock Δ 4 Wochen / 4 weeks x auf Anfrage / upon request

● empfohlen / recommended

o bedingt einsetzbar / alternative recommendation

- nicht geeignet / not suitable

■ unbeschichtete HM-Sorten / uncoated grades

■ beschichtete HM-Sorten / coated grades

■ bestückt/Cermet / brazed/Cermet

Abmessungen in mm

Dimensions in mm

P	-
M	-
K	-
N	-
S	-
H	●



HM-Sorten
Carbide grades

Schnittdaten DSKH Ø 4,0 - 12,0 mm



Cutting Data DST Ø 4,0 - 12,0 mm

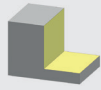

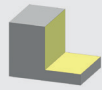

Konventionelles Fräsen / Conventional milling

		
	vc = m/min	vc = m/min
H1.1	120	150
H1.2	100	130
H1.3	80	100
H1.4	70	90

HSC Fräsen / HSC milling

		
	vc = m/min	vc = m/min
H1.1	180	220
H1.2	160	190
H1.3	140	170
H1.4	120	140

B

d ₁							
		f _z	a _e	a _p	f _z	a _e	a _p
4	5°	0,013	0,20	0,15	0,024	0,05	0,10
4	4°	0,013	0,20	0,13	0,024	0,05	0,10
4	3°	0,012	0,20	0,11	0,021	0,05	0,08
4	2°	0,011	0,20	0,09	0,019	0,05	0,06
5	5°	0,016	0,24	0,18	0,028	0,06	0,12
5	4°	0,016	0,24	0,16	0,028	0,06	0,12
5	3°	0,014	0,24	0,13	0,025	0,06	0,10
5	2°	0,012	0,24	0,11	0,022	0,06	0,07
6	5°	0,019	0,30	0,23	0,033	0,08	0,15
6	4°	0,019	0,30	0,20	0,033	0,08	0,15
6	3°	0,017	0,30	0,17	0,030	0,08	0,12
6	2°	0,015	0,30	0,14	0,027	0,08	0,09
8	5°	0,024	0,40	0,30	0,043	0,10	0,20
8	4°	0,024	0,40	0,26	0,043	0,10	0,20
8	3°	0,022	0,40	0,22	0,039	0,10	0,16
8	2°	0,020	0,40	0,18	0,034	0,10	0,12
10	5°	0,030	0,50	0,38	0,053	0,13	0,25
10	4°	0,030	0,50	0,33	0,053	0,13	0,25
10	3°	0,027	0,50	0,28	0,048	0,13	0,20
10	2°	0,024	0,50	0,23	0,042	0,13	0,15
12	5°	0,036	0,60	0,45	0,063	0,15	0,30
12	4°	0,036	0,60	0,39	0,063	0,15	0,30
12	3°	0,032	0,60	0,33	0,056	0,15	0,24
12	2°	0,029	0,60	0,27	0,050	0,15	0,18

Abmessungen in mm
Dimensions in mm

Schaftfräser Vollradius

Ball Nose End Mill



DSKH

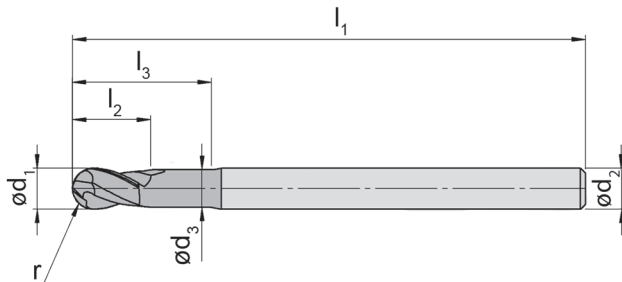

B

Bestellnummer Part number	d ₁	r	l ₂	l ₃	d ₃	d ₂	l ₁	Z	γ	TS3E
DSKH.4.040.015	4	2,0	6,0	6,0	-	6	64	4	20°	▲
DSKH.4.040.030	4	2,0	6,0	12,0	3,8	6	64	4	20°	▲
DSKH.4.040.050	4	2,0	6,0	20,0	3,8	6	64	4	20°	▲
DSKH.4.040.070	4	2,0	6,0	28,0	3,8	6	64	4	20°	▲
DSKH.4.050.015	5	2,5	7,5	7,5	-	6	64	4	20°	▲
DSKH.4.050.030	5	2,5	7,5	15,0	4,7	6	64	4	20°	▲
DSKH.4.050.050	5	2,5	7,5	25,0	4,7	6	64	4	20°	▲
DSKH.4.050.070	5	2,5	7,5	35,0	4,7	6	64	4	20°	▲
DSKH.4.060.015	6	3,0	9,0	9,0	-	6	64	4	-°	▲
DSKH.4.060.030	6	3,0	9,0	18,0	5,7	6	64	4	-°	▲
DSKH.4.060.050	6	3,0	9,0	30,0	5,7	6	78	4	-°	▲
DSKH.4.060.070	6	3,0	9,0	42,0	5,7	6	78	4	-°	▲
DSKH.4.080.015	8	4,0	12,0	12,0	-	8	64	4	-°	▲
DSKH.4.080.030	8	4,0	12,0	24,0	7,6	8	64	4	-°	▲
DSKH.4.080.050	8	4,0	12,0	40,0	7,6	8	78	4	-°	▲
DSKH.4.080.070	8	4,0	12,0	56,0	7,6	8	100	4	-°	▲
DSKH.4.100.015	10	5,0	15,0	15,0	-	10	78	4	-°	▲
DSKH.4.100.030	10	5,0	15,0	30,0	9,6	10	78	4	-°	▲
DSKH.4.100.050	10	5,0	15,0	50,0	9,6	10	100	4	-°	▲
DSKH.4.100.070	10	5,0	15,0	70,0	9,6	10	120	4	-°	▲
DSKH.4.120.015	12	6,0	18,0	18,0	-	12	78	4	-°	▲
DSKH.4.120.030	12	6,0	18,0	36,0	11,6	12	100	4	-°	▲
DSKH.4.120.050	12	6,0	18,0	60,0	11,6	12	120	4	-°	▲
DSKH.4.120.070	12	6,0	18,0	84,0	11,6	12	140	4	-°	▲

▲ ab Lager / on stock Δ 4 Wochen / 4 weeks x auf Anfrage / upon request

● empfohlen / recommended

o bedingt einsetzbar / alternative recommendation

- nicht geeignet / not suitable

■ unbeschichtete HM-Sorten / uncoated grades

■ beschichtete HM-Sorten / coated grades

■ bestückt/Cermet / brazed/Cermet

Abmessungen in mm

Dimensions in mm

P	-
M	-
K	-
N	-
S	-
H	●



HM-Sorten
Carbide grades

Schnittdaten DSKH Ø 4,0 - 12,0 mm



Cutting Data DST Ø 4,0 - 12,0 mm

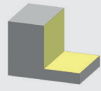

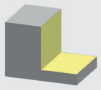

Konventionelles Fräsen / Conventional milling

		
	vc = m/min	vc = m/min
H1.1	120	150
H1.2	100	130
H1.3	80	100
H1.4	70	90

HSC Fräsen / HSC milling

		
	vc = m/min	vc = m/min
H1.1	180	220
H1.2	160	190
H1.3	140	170
H1.4	120	140

d ₁							
		f _z	a _e	a _p	f _z	a _e	a _p
4	5°	0,023	0,80	0,60	0,035	0,20	0,40
4	4°	0,023	0,80	0,52	0,035	0,20	0,40
4	3°	0,021	0,80	0,44	0,032	0,20	0,32
4	2°	0,019	0,80	0,36	0,028	0,20	0,24
5	5°	0,035	1,00	0,75	0,055	0,25	0,50
5	4°	0,035	1,00	0,65	0,055	0,25	0,50
5	3°	0,031	1,00	0,55	0,049	0,25	0,40
5	2°	0,028	1,00	0,45	0,044	0,25	0,30
6	5°	0,046	1,20	0,90	0,074	0,30	0,60
6	4°	0,046	1,20	0,78	0,074	0,30	0,60
6	3°	0,041	1,20	0,66	0,067	0,30	0,48
6	2°	0,037	1,20	0,54	0,059	0,30	0,36
8	5°	0,068	1,60	1,20	0,113	0,40	0,80
8	4°	0,068	1,60	1,04	0,113	0,40	0,80
8	3°	0,061	1,60	0,88	0,102	0,40	0,64
8	2°	0,055	1,60	0,72	0,090	0,40	0,48
10	5°	0,090	2,00	1,50	0,152	0,50	1,00
10	4°	0,090	2,00	1,30	0,152	0,50	1,00
10	3°	0,081	2,00	1,10	0,137	0,50	0,80
10	2°	0,072	2,00	0,90	0,121	0,50	0,60
12	5°	0,113	2,40	1,80	0,191	0,60	1,20
12	4°	0,113	2,40	1,56	0,191	0,60	1,20
12	3°	0,102	2,40	1,32	0,172	0,60	0,96
12	2°	0,090	2,40	1,08	0,153	0,60	0,72

Abmessungen in mm
Dimensions in mm

B

DSTMH

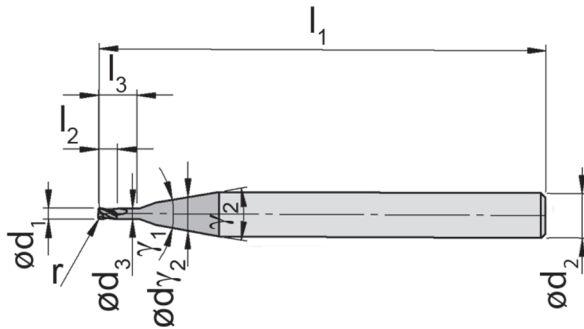
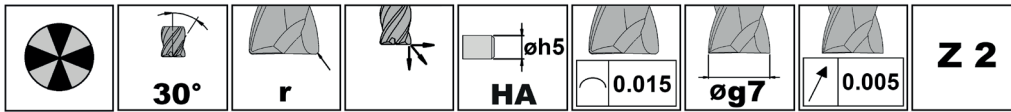

B

Bestellnummer Part number	d ₁	r	l ₂	l ₃	d ₃	d ₂	l ₁	Z	γ ₁	γ ₂	d _{y2}	TS3E
DSTMH.010.000.015	0,1	0	0,15	0,15	-	4	50	2	20°	-°	-	▲
DSTMH.010.000.030	0,1	0	0,15	0,30	0,084	4	50	2	20°	-°	-	▲
DSTMH.020.000.015	0,2	0	0,30	0,30	-	4	50	2	20°	-°	-	▲
DSTMH.020.000.030	0,2	0	0,30	0,60	0,180	4	50	2	40°	20°	1,5	▲
DSTMH.020.000.050	0,2	0	0,30	1,00	0,180	4	50	2	40°	20°	1,5	▲
DSTMH.030.005.015	0,3	0,05	0,45	0,45	-	4	50	2	20°	-°	-	▲
DSTMH.030.005.030	0,3	0,05	0,45	0,90	0,280	4	50	2	40°	20°	1,5	▲
DSTMH.030.005.050	0,3	0,05	0,45	1,50	0,280	4	50	2	40°	20°	1,5	▲
DSTMH.040.005.015	0,4	0,05	0,60	0,60	-	4	50	2	20°	-°	-	▲
DSTMH.040.005.030	0,4	0,05	0,60	1,20	0,380	4	50	2	40°	20°	1,5	▲
DSTMH.040.005.050	0,4	0,05	0,60	2,00	0,380	4	50	2	40°	20°	1,5	▲
DSTMH.050.005.015	0,5	0,05	0,75	0,75	-	4	50	2	20°	-°	-	▲
DSTMH.050.005.030	0,5	0,05	0,75	1,50	0,470	4	50	2	40°	20°	1,5	▲
DSTMH.050.005.050	0,5	0,05	0,75	2,50	0,470	4	50	2	40°	20°	1,5	▲
DSTMH.050.005.070	0,5	0,05	0,75	3,50	0,470	4	50	2	40°	20°	1,5	▲
DSTMH.050.010.015	0,5	0,10	0,75	0,75	-	4	50	2	20°	-°	-	▲
DSTMH.050.010.030	0,5	0,10	0,75	1,50	0,470	4	50	2	40°	20°	1,5	▲
DSTMH.050.010.050	0,5	0,10	0,75	2,50	0,470	4	50	2	40°	20°	1,5	▲
DSTMH.050.010.070	0,5	0,10	0,75	3,50	0,470	4	50	2	40°	20°	1,5	▲
DSTMH.060.005.015	0,6	0,05	0,90	0,90	-	4	50	2	20°	-°	-	▲
DSTMH.060.005.030	0,6	0,05	0,90	1,80	0,560	4	50	2	40°	20°	1,5	▲
DSTMH.060.005.050	0,6	0,05	0,90	3,00	0,560	4	50	2	40°	20°	1,5	▲
DSTMH.060.005.070	0,6	0,05	0,90	4,20	0,560	4	50	2	40°	20°	1,5	▲
DSTMH.060.010.015	0,6	0,10	0,90	0,90	-	4	50	2	20°	-°	-	▲
DSTMH.060.010.030	0,6	0,10	0,90	1,80	0,560	4	50	2	40°	20°	1,5	▲
DSTMH.060.010.050	0,6	0,10	0,90	3,00	0,560	4	50	2	40°	20°	1,5	▲
DSTMH.060.010.070	0,6	0,10	0,90	4,20	0,560	4	50	2	40°	20°	1,5	▲

▲ ab Lager / on stock Δ 4 Wochen / 4 weeks x auf Anfrage / upon request

● empfohlen / recommended

○ bedingt einsetzbar / alternative recommendation

- nicht geeignet / not suitable

■ unbeschichtete HM-Sorten / uncoated grades

■ beschichtete HM-Sorten / coated grades

■ bestückt/Cermet / brazed/Cermet

Abmessungen in mm

Dimensions in mm

P	-
M	-
K	-
N	-
S	-
H	●



HM-Sorten
Carbide grades

Schnittdaten DSTMH Ø 0,1 - 0,6 mm



Cutting Data DSTMH Ø 0,1 - 0,6 mm

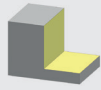

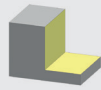

Konventionelles Fräsen / Conventional milling

		
	vc = m/min	vc = m/min
H1.1	120	150
H1.2	100	130
H1.3	80	100
H1.4	70	90

HSC Fräsen / HSC milling

		
	vc = m/min	vc = m/min
H1.1	180	220
H1.2	160	190
H1.3	140	170
H1.4	120	140

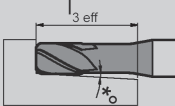

d ₁												
		0°	0,5°	1°	2°	3°	f _z	a _e	a _p	f _z	a _e	a _p
0,1	5°	0,15	0,30	0,30	0,40	0,40	0,003	0,02	0,02	0,005	0,01	0,01
0,1	4°	0,30	0,50	0,50	0,60	0,70	0,003	0,02	0,01	0,005	0,01	0,01
0,2	5°	0,30	0,50	0,50	0,60	0,70	0,004	0,04	0,03	0,007	0,02	0,02
0,2	4°	0,60	0,70	0,70	0,80	0,90	0,004	0,04	0,03	0,007	0,02	0,02
0,2	3°	1,00	1,10	1,20	1,30	1,40	0,004	0,04	0,02	0,006	0,02	0,02
0,3	5°	0,45	0,60	0,70	0,80	0,90	0,005	0,06	0,05	0,008	0,02	0,03
0,3	4°	0,90	1,00	1,10	1,20	1,20	0,005	0,06	0,04	0,008	0,02	0,03
0,3	3°	1,50	1,60	1,70	1,80	1,90	0,005	0,06	0,03	0,007	0,02	0,02
0,4	5°	0,60	0,80	0,80	0,90	1,10	0,007	0,08	0,06	0,010	0,03	0,04
0,4	4°	1,20	1,40	1,40	1,50	1,60	0,007	0,08	0,05	0,010	0,03	0,04
0,4	3°	2,00	2,20	2,30	2,40	2,50	0,006	0,08	0,04	0,009	0,03	0,03
0,5	5°	0,75	1,00	1,00	1,10	1,30	0,008	0,10	0,08	0,011	0,04	0,05
0,5	4°	1,50	1,70	1,70	1,90	2,00	0,008	0,10	0,07	0,011	0,04	0,05
0,5	3°	2,50	2,70	2,80	3,00	3,10	0,007	0,10	0,06	0,010	0,04	0,04
0,5	2°	3,50	3,70	3,90	4,10	4,30	0,006	0,10	0,05	0,009	0,04	0,03
0,5	5°	0,75	1,00	1,00	1,10	1,30	0,008	0,10	0,08	0,011	0,04	0,05
0,5	4°	1,50	1,70	1,70	1,90	2,00	0,008	0,10	0,07	0,011	0,04	0,05
0,5	3°	2,50	2,70	2,80	3,00	3,10	0,007	0,10	0,06	0,010	0,04	0,04
0,5	2°	3,50	3,70	3,90	4,10	4,30	0,006	0,10	0,05	0,009	0,04	0,03
0,6	5°	0,90	1,10	1,20	1,30	1,50	0,009	0,12	0,09	0,013	0,05	0,06
0,6	4°	1,80	2,00	2,10	2,20	2,30	0,009	0,12	0,08	0,013	0,05	0,06
0,6	3°	3,00	3,30	3,40	3,50	3,70	0,008	0,12	0,07	0,012	0,05	0,05
0,6	2°	4,20	4,50	4,60	4,90	5,10	0,007	0,12	0,05	0,010	0,05	0,04
0,6	5°	0,90	1,10	1,20	1,30	1,50	0,009	0,12	0,09	0,013	0,05	0,06
0,6	4°	1,80	2,00	2,10	2,20	2,30	0,009	0,12	0,08	0,013	0,05	0,06
0,6	3°	3,00	3,30	3,30	3,50	3,70	0,008	0,12	0,07	0,012	0,05	0,05
0,6	2°	4,20	4,50	4,60	4,90	5,10	0,007	0,12	0,05	0,010	0,05	0,04

Abmessungen in mm
Dimensions in mm

DSTMH

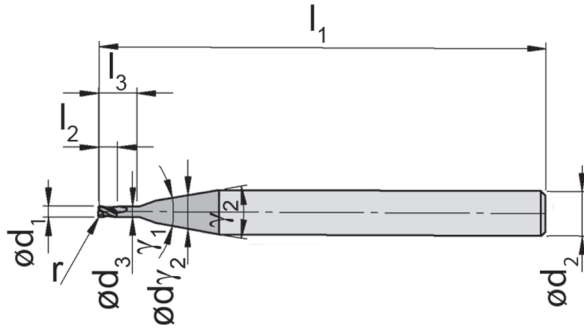
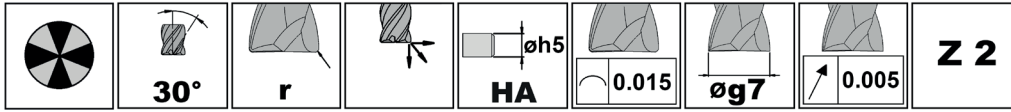

B

Bestellnummer Part number	d ₁	r	l ₂	l ₃	d ₃	d ₂	l ₁	Z	γ ₁	γ ₂	d _{v2}	TS3E
DSTMH.080.005.015	0,8	0,05	1,2	1,2	-	4	50	2	20°	-°	-	▲
DSTMH.080.005.030	0,8	0,05	1,2	2,4	0,75	4	50	2	40°	20°	1,5	▲
DSTMH.080.005.050	0,8	0,05	1,2	4,0	0,75	4	50	2	40°	20°	1,5	▲
DSTMH.080.005.070	0,8	0,05	1,2	5,6	0,75	4	50	2	40°	20°	1,5	▲
DSTMH.080.010.015	0,8	0,10	1,2	1,2	-	4	50	2	20°	-°	-	▲
DSTMH.080.010.030	0,8	0,10	1,2	2,4	0,75	4	50	2	40°	20°	1,5	▲
DSTMH.080.010.050	0,8	0,10	1,2	4,0	0,75	4	50	2	40°	20°	1,5	▲
DSTMH.080.010.070	0,8	0,10	1,2	5,6	0,75	4	50	2	40°	20°	1,5	▲
DSTMH.100.005.015	1,0	0,05	1,5	1,5	-	4	50	2	20°	-°	-	▲
DSTMH.100.005.030	1,0	0,05	1,5	3,0	0,95	4	50	2	40°	20°	2,0	▲
DSTMH.100.005.050	1,0	0,05	1,5	5,0	0,95	4	50	2	40°	20°	2,0	▲
DSTMH.100.005.070	1,0	0,05	1,5	7,0	0,95	4	50	2	40°	20°	2,0	▲
DSTMH.100.010.015	1,0	0,10	1,5	1,5	-	4	50	2	20°	-°	-	▲
DSTMH.100.010.030	1,0	0,10	1,5	3,0	0,95	4	50	2	40°	20°	2,0	▲
DSTMH.100.010.050	1,0	0,10	1,5	5,0	0,95	4	50	2	40°	20°	2,0	▲
DSTMH.100.010.070	1,0	0,10	1,5	7,0	0,95	4	50	2	40°	20°	2,0	▲
DSTMH.120.010.015	1,2	0,10	1,8	1,8	-	4	50	2	20°	-°	-	▲
DSTMH.120.010.030	1,2	0,10	1,8	3,6	1,15	4	50	2	40°	20°	2,0	▲
DSTMH.120.010.050	1,2	0,10	1,8	6,0	1,15	4	50	2	40°	20°	2,0	▲
DSTMH.120.010.070	1,2	0,10	1,8	8,4	1,15	4	50	2	40°	20°	2,0	▲

▲ ab Lager / on stock Δ 4 Wochen / 4 weeks x auf Anfrage / upon request

● empfohlen / recommended

o bedingt einsetzbar / alternative recommendation

- nicht geeignet / not suitable

■ unbeschichtete HM-Sorten / uncoated grades

■ beschichtete HM-Sorten / coated grades

■ bestückt/Cermet / brazed/Cermet

Abmessungen in mm

Dimensions in mm

P	-
M	-
K	-
N	-
S	-
H	•



HM-Sorten
Carbide grades

Schnittdaten DSTMH Ø 0,8 - 1,2 mm



Cutting Data DSTMH Ø 0,8 - 1,2 mm

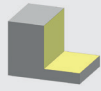

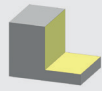

Konventionelles Fräsen / Conventional milling

		
	vc = m/min	vc = m/min
H1.1	120	150
H1.2	100	130
H1.3	80	100
H1.4	70	90

HSC Fräsen / HSC milling

		
	vc = m/min	vc = m/min
H1.1	180	220
H1.2	160	190
H1.3	140	170
H1.4	120	140

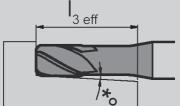
B

d ₁												
		0°	0,5°	1°	2°	3°	f _z	a _e	a _p	f _z	a _e	a _p
0,1	5°	1,20	1,40	1,50	1,70	1,90	0,011	0,16	0,12	0,016	0,06	0,08
0,1	4°	2,40	2,70	2,70	2,90	3,00	0,011	0,16	0,10	0,016	0,06	0,08
0,2	5°	4,00	4,30	4,40	4,70	4,90	0,010	0,16	0,09	0,015	0,06	0,06
0,2	4°	5,60	5,90	6,10	6,40	6,80	0,009	0,16	0,07	0,013	0,06	0,05
0,2	3°	1,20	1,40	1,50	1,70	1,90	0,011	0,16	0,12	0,016	0,06	0,08
0,3	5°	2,40	2,60	2,70	2,90	3,00	0,011	0,16	0,10	0,016	0,06	0,08
0,3	4°	4,00	4,30	4,40	4,60	4,90	0,010	0,16	0,09	0,015	0,06	0,06
0,3	3°	5,60	5,90	6,10	6,40	6,80	0,009	0,16	0,07	0,013	0,06	0,05
0,4	5°	1,50	1,70	1,80	2,10	2,40	0,013	0,20	0,15	0,019	0,08	0,10
0,4	4°	3,00	3,30	3,40	3,50	3,70	0,013	0,20	0,13	0,019	0,08	0,10
0,4	3°	5,00	5,30	5,50	5,80	6,10	0,012	0,20	0,11	0,017	0,08	0,08
0,5	5°	7,00	7,40	7,60	8,00	8,40	0,011	0,20	0,09	0,015	0,08	0,06
0,5	4°	1,50	1,70	1,80	2,10	2,30	0,013	0,20	0,15	0,019	0,08	0,10
0,5	3°	3,00	3,30	3,40	3,50	3,70	0,013	0,20	0,13	0,019	0,08	0,10
0,5	2°	5,00	5,30	5,50	5,80	6,10	0,012	0,20	0,11	0,017	0,08	0,08
0,5	5°	7,00	7,40	7,60	8,00	8,40	0,011	0,20	0,09	0,015	0,08	0,06
0,5	4°	1,80	2,10	2,20	2,40	2,70	0,016	0,24	0,18	0,022	0,09	0,12
0,5	3°	3,60	3,90	4,00	4,20	4,40	0,016	0,24	0,16	0,022	0,09	0,12
0,5	2°	6,00	6,40	6,50	6,90	7,20	0,014	0,24	0,13	0,020	0,09	0,10
0,6	5°	8,40	8,80	9,00	8,50	10,60	0,012	0,24	0,11	0,018	0,09	0,07

Abmessungen in mm
Dimensions in mm

Mikrofräser Torus

Micro End Mill Torus



DSTMH

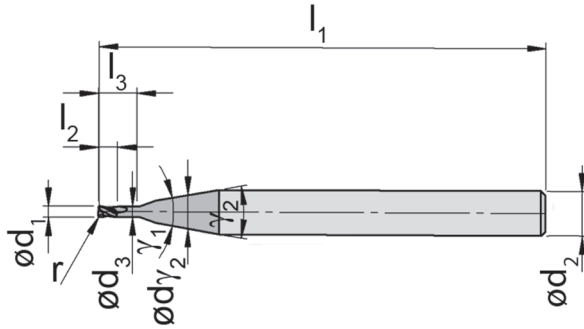
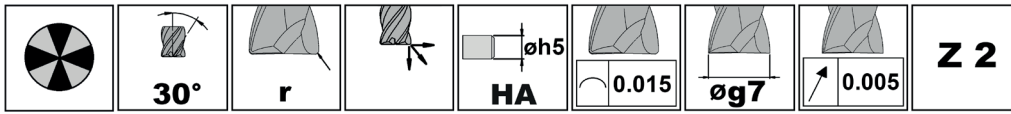

B

Bestellnummer Part number	d ₁	r	l ₂	l ₃	d ₃	d ₂	l ₁	Z	γ ₁	γ ₂	d _{γ₂}	TS3E
DSTMH.150.010.015	1,5	0,1	2,25	2,25	-	4	50	2	20°	-°	-	▲
DSTMH.150.010.030	1,5	0,1	2,25	4,50	1,45	4	50	2	40°	20°	2,5	▲
DSTMH.150.010.050	1,5	0,1	2,25	7,50	1,45	4	50	2	40°	20°	2,5	▲
DSTMH.150.010.070	1,5	0,1	2,25	10,50	1,45	4	50	2	40°	20°	2,5	▲
DSTMH.150.020.015	1,5	0,2	2,25	2,25	-	4	50	2	20°	-°	-	▲
DSTMH.150.020.030	1,5	0,2	2,25	4,50	1,45	4	50	2	40°	20°	2,5	▲
DSTMH.150.020.050	1,5	0,2	2,25	7,50	1,45	4	50	2	40°	20°	2,5	▲
DSTMH.150.020.070	1,5	0,2	2,25	10,50	1,45	4	50	2	40°	20°	2,5	▲
DSTMH.150.050.015	1,5	0,5	2,25	2,25	-	4	50	2	20°	-°	-	▲
DSTMH.150.050.030	1,5	0,5	2,25	4,50	1,45	4	50	2	40°	20°	2,5	▲
DSTMH.150.050.050	1,5	0,5	2,25	7,50	1,45	4	50	2	40°	20°	2,5	▲
DSTMH.150.050.070	1,5	0,5	2,25	10,50	1,45	4	50	2	40°	20°	2,5	▲
DSTMH.200.010.015	2,0	0,1	3,00	3,00	-	4	50	2	20°	-°	-	▲
DSTMH.200.010.030	2,0	0,1	3,00	6,00	1,90	4	50	2	40°	20°	3,0	▲
DSTMH.200.010.050	2,0	0,1	3,00	10,00	1,90	4	50	2	40°	20°	3,0	▲
DSTMH.200.010.070	2,0	0,1	3,00	14,00	1,90	4	50	2	40°	20°	3,0	▲
DSTMH.200.020.015	2,0	0,2	3,00	3,00	-	4	50	2	20°	-°	-	▲
DSTMH.200.020.030	2,0	0,2	3,00	6,00	1,90	4	50	2	40°	20°	3,0	▲
DSTMH.200.020.050	2,0	0,2	3,00	10,00	1,90	4	50	2	40°	20°	3,0	▲
DSTMH.200.020.070	2,0	0,2	3,00	14,00	1,90	4	50	2	40°	20°	3,0	▲
DSTMH.200.050.015	2,0	0,5	3,00	3,00	-	4	50	2	20°	-°	-	▲
DSTMH.200.050.030	2,0	0,5	3,00	6,00	1,90	4	50	2	40°	20°	3,0	▲
DSTMH.200.050.050	2,0	0,5	3,00	10,00	1,90	4	50	2	40°	20°	3,0	▲
DSTMH.200.050.070	2,0	0,5	3,00	14,00	1,90	4	50	2	40°	20°	3,0	▲

▲ ab Lager / on stock Δ 4 Wochen / 4 weeks x auf Anfrage / upon request

● empfohlen / recommended

o bedingt einsetzbar / alternative recommendation

- nicht geeignet / not suitable

■ unbeschichtete HM-Sorten / uncoated grades

■ beschichtete HM-Sorten / coated grades

■ bestückt/Cermet / brazed/Cermet

Abmessungen in mm

Dimensions in mm

P	-
M	-
K	-
N	-
S	-
H	•



HM-Sorten
Carbide grades

Schnittdaten DSTMH Ø 1,5 - 2,0 mm



Cutting Data DSTMH Ø 1,5 - 2,0 mm

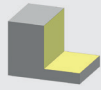

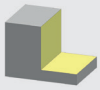

Konventionelles Fräsen / Conventional milling

		
	vc = m/min	vc = m/min
H1.1	120	150
H1.2	100	130
H1.3	80	100
H1.4	70	90

HSC Fräsen / HSC milling

		
	vc = m/min	vc = m/min
H1.1	180	220
H1.2	160	190
H1.3	140	170
H1.4	120	140

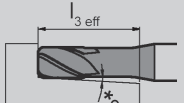
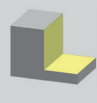
B

d ₁												
		0°	0,5°	1°	2°	3°	f _z	a _e	a _p	f _z	a _e	a _p
1,5	5°	2,25	2,50	2,70	3,00	3,40	0,019	0,30	0,23	0,027	0,11	0,15
1,5	4°	4,50	4,80	4,90	5,20	5,50	0,019	0,30	0,20	0,027	0,11	0,15
1,5	3°	7,50	7,90	8,10	8,50	9,00	0,017	0,30	0,17	0,025	0,11	0,12
1,5	2°	10,50	11,00	11,20	11,80	13,10	0,015	0,30	0,14	0,022	0,11	0,09
1,5	5°	2,25	2,50	2,70	3,00	3,40	0,019	0,30	0,23	0,027	0,11	0,15
1,5	4°	4,50	4,80	4,90	5,20	5,50	0,019	0,30	0,20	0,027	0,11	0,15
1,5	3°	7,50	7,90	8,10	8,50	9,00	0,017	0,30	0,17	0,025	0,11	0,12
1,5	2°	10,50	11,00	11,20	11,80	13,10	0,015	0,30	0,14	0,022	0,11	0,09
1,5	5°	2,25	2,50	2,60	2,90	3,20	0,019	0,30	0,23	0,027	0,11	0,15
1,5	4°	4,50	4,80	4,90	5,20	5,40	0,019	0,30	0,20	0,027	0,11	0,15
1,5	3°	7,50	7,90	8,10	8,50	8,90	0,017	0,30	0,17	0,025	0,11	0,12
1,5	2°	10,50	11,00	11,20	11,80	13,00	0,015	0,30	0,14	0,022	0,11	0,09
2,0	5°	3,00	3,30	3,50	3,90	4,50	0,024	0,40	0,30	0,035	0,15	0,20
2,0	4°	6,00	6,40	6,60	6,90	7,30	0,024	0,40	0,26	0,035	0,15	0,20
2,0	3°	10,00	10,50	10,80	11,30	12,50	0,022	0,40	0,22	0,032	0,15	0,16
2,0	2°	14,00	14,60	15,00	16,00	18,20	0,020	0,40	0,18	0,028	0,15	0,12
2,0	5°	3,00	3,30	3,50	3,90	4,40	0,024	0,40	0,30	0,035	0,15	0,20
2,0	4°	6,00	6,40	6,60	6,90	7,30	0,024	0,40	0,26	0,035	0,15	0,20
2,0	3°	10,00	10,50	10,80	11,30	12,50	0,022	0,40	0,22	0,032	0,15	0,16
2,0	2°	14,00	14,60	15,00	15,90	18,20	0,020	0,40	0,18	0,028	0,15	0,12
2,0	5°	3,00	3,30	3,50	3,80	4,30	0,024	0,40	0,30	0,035	0,15	0,20
2,0	4°	6,00	6,40	6,60	6,90	7,30	0,024	0,40	0,26	0,035	0,15	0,20
2,0	3°	10,00	10,50	10,80	11,30	12,30	0,022	0,40	0,22	0,032	0,15	0,16
2,0	2°	14,00	14,60	15,00	15,90	18,00	0,020	0,40	0,18	0,028	0,15	0,12

Abmessungen in mm
Dimensions in mm

DSTMH

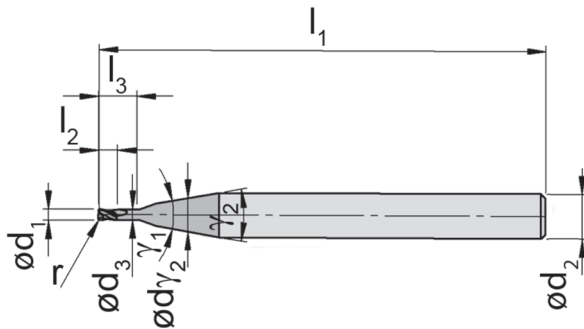
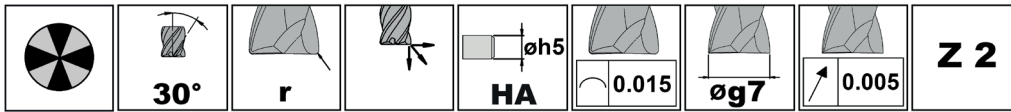

Bis Ø 3 mm vormontiert lieferbar für Toodle Schnelllaufspindel
Pre-assembled available up to Ø 3 mm for Toodle high-speed spindle

Bestellnummer Part number	d ₁	r	l ₂	l ₃	d ₃	d ₂	l ₁	Z	γ ₁	γ ₂	d _{v2}	TS3E
DSTMH.250.010.015	2,5	0,1	3,75	3,75	-	4	50	2	20°	-°	-	▲
DSTMH.250.010.030	2,5	0,1	3,75	7,50	2,4	4	50	2	40°	20°	3,5	▲
DSTMH.250.010.050	2,5	0,1	3,75	12,50	2,4	4	50	2	40°	20°	3,5	▲
DSTMH.250.010.070	2,5	0,1	3,75	17,50	2,4	4	50	2	40°	20°	3,5	▲
DSTMH.250.020.015	2,5	0,2	3,75	3,75	-	4	50	2	20°	-°	-	▲
DSTMH.250.020.030	2,5	0,2	3,75	7,50	2,4	4	50	2	40°	20°	3,5	▲
DSTMH.250.020.050	2,5	0,2	3,75	12,50	2,4	4	50	2	40°	20°	3,5	▲
DSTMH.250.020.070	2,5	0,2	3,75	17,50	2,4	4	50	2	40°	20°	3,5	▲
DSTMH.250.050.015	2,5	0,5	3,75	3,75	-	4	50	2	20°	-°	-	▲
DSTMH.250.050.030	2,5	0,5	3,75	7,50	2,4	4	50	2	40°	20°	3,5	▲
DSTMH.250.050.050	2,5	0,5	3,75	12,50	2,4	4	50	2	40°	20°	3,5	▲
DSTMH.250.050.070	2,5	0,5	3,75	17,50	2,4	4	50	2	40°	20°	3,5	▲
DSTMH.300.010.015	3,0	0,1	4,50	4,50	-	4	50	2	20°	-°	-	▲
DSTMH.300.010.030	3,0	0,1	4,50	9,00	2,9	4	50	2	40°	20°	3,5	▲
DSTMH.300.010.050	3,0	0,1	4,50	15,00	2,9	4	50	2	40°	20°	3,5	▲
DSTMH.300.010.070	3,0	0,1	4,50	21,00	2,9	4	60	2	40°	20°	3,5	▲
DSTMH.300.020.015	3,0	0,2	4,50	4,50	-	4	50	2	20°	-°	-	▲
DSTMH.300.020.030	3,0	0,2	4,50	9,00	2,9	4	50	2	40°	20°	3,5	▲
DSTMH.300.020.050	3,0	0,2	4,50	15,00	2,9	4	50	2	40°	20°	3,5	▲
DSTMH.300.020.070	3,0	0,2	4,50	21,00	2,9	4	60	2	40°	20°	3,5	▲
DSTMH.300.050.015	3,0	0,5	4,50	4,50	-	4	50	2	20°	-°	-	▲
DSTMH.300.050.030	3,0	0,5	4,50	9,00	2,9	4	50	2	40°	20°	3,5	▲
DSTMH.300.050.050	3,0	0,5	4,50	15,00	2,9	4	50	2	40°	20°	3,5	▲
DSTMH.300.050.070	3,0	0,5	4,50	21,00	2,9	4	60	2	40°	20°	3,5	▲
DSTMH.300.100.015	3,0	1,0	4,50	4,50	-	4	50	2	20°	-°	-	▲
DSTMH.300.100.030	3,0	1,0	4,50	9,00	2,9	4	50	2	40°	20°	3,5	▲
DSTMH.300.100.050	3,0	1,0	4,50	15,00	2,9	4	50	2	40°	20°	3,5	▲
DSTMH.300.100.070	3,0	1,0	4,50	21,00	2,9	4	60	2	40°	20°	3,5	▲

▲ ab Lager / on stock Δ 4 Wochen / 4 weeks x auf Anfrage / upon request

● empfohlen / recommended

o bedingt einsetzbar / alternative recommendation

- nicht geeignet / not suitable

■ unbeschichtete HM-Sorten / uncoated grades

■ beschichtete HM-Sorten / coated grades

■ bestückt/Cermet / brazed/Cermet



P	-
M	-
K	-
N	-
S	-
H	•

Schnittdaten DSTMH Ø 2,5 - 3,0 mm



Cutting Data DSTMH Ø 2,5 - 3,0 mm





Konventionelles Fräsen / Conventional milling

		
	vc = m/min	vc = m/min
H1.1	120	150
H1.2	100	130
H1.3	80	100
H1.4	70	90

HSC Fräsen / HSC milling

		
	vc = m/min	vc = m/min
H1.1	180	220
H1.2	160	190
H1.3	140	170
H1.4	120	140

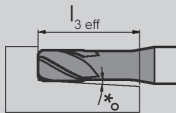

d ₁												
		0°	0,5°	1°	2°	3°	f _z	a _e	a _p	f _z	a _e	a _p
2,5	5°	3,75	4,10	4,30	4,90	5,50	0,030	0,50	0,38	0,043	0,19	0,25
2,5	4°	7,50	8,00	8,20	8,60	9,10	0,030	0,50	0,33	0,043	0,19	0,25
2,5	3°	12,50	13,10	13,40	14,10	∞	0,027	0,50	0,28	0,039	0,19	0,20
2,5	2°	17,50	18,20	18,70	20,30	∞	0,024	0,50	0,23	0,035	0,19	0,15
2,5	5°	3,75	4,10	4,30	4,80	5,50	0,030	0,50	0,38	0,043	0,19	0,25
2,5	4°	7,50	8,00	8,20	8,60	9,10	0,030	0,50	0,33	0,043	0,19	0,25
2,5	3°	12,50	13,10	13,40	14,10	∞	0,027	0,50	0,28	0,039	0,19	0,20
2,5	2°	17,50	18,20	18,70	20,30	∞	0,024	0,50	0,23	0,035	0,19	0,15
2,5	5°	3,75	4,10	4,30	4,80	5,40	0,030	0,50	0,38	0,043	0,19	0,25
2,5	4°	7,50	8,00	8,10	8,60	9,00	0,030	0,50	0,33	0,043	0,19	0,25
2,5	3°	12,50	13,10	13,40	14,00	∞	0,027	0,50	0,28	0,039	0,19	0,20
2,5	2°	17,50	18,20	18,60	20,20	∞	0,024	0,50	0,23	0,035	0,19	0,15
3,0	5°	4,50	4,90	5,20	5,80	6,60	0,036	0,60	0,45	0,051	0,23	0,30
3,0	4°	9,00	9,50	9,70	10,60	∞	0,036	0,60	0,39	0,051	0,23	0,30
3,0	3°	15,00	15,70	16,10	∞	∞	0,032	0,60	0,33	0,046	0,23	0,24
3,0	2°	21,00	21,80	22,80	∞	∞	0,029	0,60	0,27	0,041	0,23	0,18
3,0	5°	4,50	4,90	5,20	5,80	6,60	0,036	0,60	0,45	0,051	0,23	0,30
3,0	4°	9,00	9,50	9,70	10,60	∞	0,036	0,60	0,39	0,051	0,23	0,30
3,0	3°	15,00	15,60	16,10	∞	∞	0,032	0,60	0,33	0,046	0,23	0,24
3,0	2°	21,00	21,80	22,80	∞	∞	0,029	0,60	0,27	0,041	0,23	0,18
3,0	5°	4,50	4,90	5,10	5,70	6,40	0,036	0,60	0,45	0,051	0,23	0,30
3,0	4°	9,00	9,50	9,70	10,50	∞	0,036	0,60	0,39	0,051	0,23	0,30
3,0	3°	15,00	15,60	16,10	∞	∞	0,032	0,60	0,33	0,046	0,23	0,24
3,0	2°	21,00	21,80	22,80	∞	∞	0,029	0,60	0,27	0,041	0,23	0,18
3,0	5°	4,50	4,90	5,10	5,60	6,20	0,036	0,60	0,45	0,051	0,23	0,30
3,0	4°	9,00	9,50	9,70	10,40	∞	0,036	0,60	0,39	0,051	0,23	0,30
3,0	3°	15,00	15,60	16,00	∞	∞	0,032	0,60	0,33	0,046	0,23	0,24
3,0	2°	21,00	21,80	22,70	∞	∞	0,029	0,60	0,27	0,041	0,23	0,18

Abmessungen in mm
Dimensions in mm

DSTH

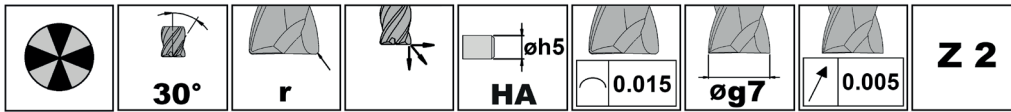

B

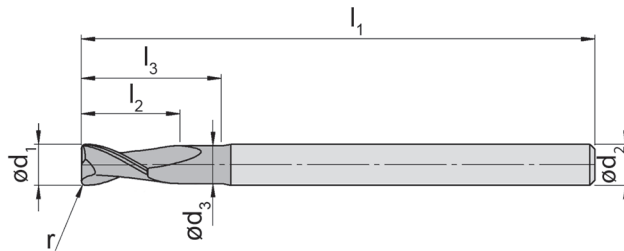

Bestellnummer Part number	d ₁	r	l ₂	l ₃	d ₃	d ₂	l ₁	Z	γ	TS3E
DSTH.2.040.020.015	4	0,2	6	6	-	6	64	2	20°	▲
DSTH.2.040.020.030	4	0,2	6	12	3,8	6	64	2	20°	▲
DSTH.2.040.020.050	4	0,2	6	20	3,8	6	64	2	20°	▲
DSTH.2.040.020.070	4	0,2	6	28	3,8	6	78	2	20°	▲
DSTH.2.040.050.015	4	0,5	6	6	-	6	64	2	20°	▲
DSTH.2.040.050.030	4	0,5	6	12	3,8	6	64	2	20°	▲
DSTH.2.040.050.050	4	0,5	6	20	3,8	6	64	2	20°	▲
DSTH.2.040.050.070	4	0,5	6	28	3,8	6	78	2	20°	▲
DSTH.2.040.100.015	4	1,0	6	6	-	6	64	2	20°	▲
DSTH.2.040.100.030	4	1,0	6	12	3,8	6	64	2	20°	▲
DSTH.2.040.100.050	4	1,0	6	20	3,8	6	64	2	20°	▲
DSTH.2.040.100.070	4	1,0	6	28	3,8	6	78	2	20°	▲

▲ ab Lager / on stock Δ 4 Wochen / 4 weeks x auf Anfrage / upon request

● empfohlen / recommended

o bedingt einsetzbar / alternative recommendation

- nicht geeignet / not suitable

■ unbeschichtete HM-Sorten / uncoated grades

■ beschichtete HM-Sorten / coated grades

■ bestückt/Cermet / brazed/Cermet

Abmessungen in mm

Dimensions in mm

P	-
M	-
K	-
N	-
S	-
H	•



HM-Sorten
Carbide grades

Schnittdaten DSTH Ø 4,0 mm



Cutting Data DSTH Ø 4,0 mm



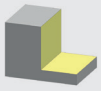

Konventionelles Fräsen / Conventional milling

		
	vc = m/min	vc = m/min
H1.1	120	150
H1.2	100	130
H1.3	80	100
H1.4	70	90

HSC Fräsen / HSC milling

		
	vc = m/min	vc = m/min
H1.1	180	220
H1.2	160	190
H1.3	140	170
H1.4	120	140

B

d ₁							
		f _z	a _e	a _p	f _z	a _e	a _p
4	5°	0,047	0,80	0,60	0,067	0,30	0,40
4	4°	0,047	0,80	0,52	0,067	0,30	0,40
4	3°	0,042	0,80	0,44	0,060	0,30	0,32
4	2°	0,037	0,80	0,36	0,054	0,30	0,24
4	5°	0,047	0,80	0,60	0,067	0,30	0,40
4	4°	0,047	0,80	0,52	0,067	0,30	0,40
4	3°	0,042	0,80	0,44	0,060	0,30	0,32
4	2°	0,037	0,80	0,36	0,054	0,30	0,24
4	5°	0,047	0,80	0,60	0,067	0,30	0,40
4	4°	0,047	0,80	0,52	0,067	0,30	0,40
4	3°	0,042	0,80	0,44	0,060	0,30	0,32
4	2°	0,037	0,80	0,36	0,054	0,30	0,24

Abmessungen in mm
Dimensions in mm

DSTH

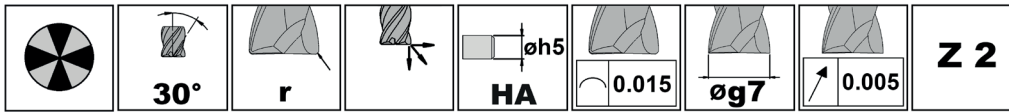

B

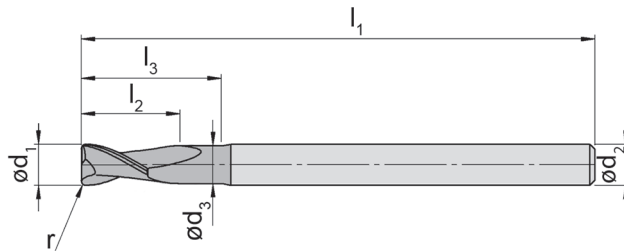

Bestellnummer Part number	d ₁	r	l ₂	l ₃	d ₃	d ₂	l ₁	Z	γ	TS3E
DSTH.2.050.020.015	5	0,2	7,5	7,5	-	6	64	2	20°	▲
DSTH.2.050.020.030	5	0,2	7,5	15,0	4,7	6	64	2	20°	▲
DSTH.2.050.020.050	5	0,2	7,5	25,0	4,7	6	64	2	20°	▲
DSTH.2.050.020.070	5	0,2	7,5	35,0	4,7	6	78	2	20°	▲
DSTH.2.050.050.015	5	0,5	7,5	7,5	-	6	64	2	20°	▲
DSTH.2.050.050.030	5	0,5	7,5	15,0	4,7	6	64	2	20°	▲
DSTH.2.050.050.050	5	0,5	7,5	25,0	4,7	6	64	2	20°	▲
DSTH.2.050.050.070	5	0,5	7,5	35,0	4,7	6	78	2	20°	▲
DSTH.2.050.100.015	5	1,0	7,5	7,5	-	6	64	2	20°	▲
DSTH.2.050.100.030	5	1,0	7,5	15,0	4,7	6	64	2	20°	▲
DSTH.2.050.100.050	5	1,0	7,5	25,0	4,7	6	64	2	20°	▲
DSTH.2.050.100.070	5	1,0	7,5	35,0	4,7	6	78	2	20°	▲

▲ ab Lager / on stock Δ 4 Wochen / 4 weeks x auf Anfrage / upon request

● empfohlen / recommended

o bedingt einsetzbar / alternative recommendation

- nicht geeignet / not suitable

■ unbeschichtete HM-Sorten / uncoated grades

■ beschichtete HM-Sorten / coated grades

■ bestückt/Cermet / brazed/Cermet

Abmessungen in mm

Dimensions in mm

P	-
M	-
K	-
N	-
S	-
H	•



HM-Sorten
Carbide grades

Schnittdaten DSTH Ø 5,0 mm



Cutting Data DSTH Ø 5,0 mm

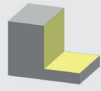

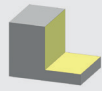

Konventionelles Fräsen / Conventional milling

		
	vc = m/min	vc = m/min
H1.1	120	150
H1.2	100	130
H1.3	80	100
H1.4	70	90

HSC Fräsen / HSC milling

		
	vc = m/min	vc = m/min
H1.1	180	220
H1.2	160	190
H1.3	140	170
H1.4	120	140

B

d ₁							
		f _z	a _e	a _p	f _z	a _e	a _p
5	5°	0,058	1,00	0,75	0,083	0,38	0,50
5	4°	0,058	1,00	0,65	0,083	0,38	0,50
5	3°	0,052	1,00	0,55	0,075	0,38	0,40
5	2°	0,046	1,00	0,45	0,066	0,38	0,30
5	5°	0,058	1,00	0,75	0,083	0,38	0,50
5	4°	0,058	1,00	0,65	0,083	0,38	0,50
5	3°	0,052	1,00	0,55	0,075	0,38	0,40
5	2°	0,046	1,00	0,45	0,066	0,38	0,30
5	5°	0,058	1,00	0,75	0,083	0,38	0,50
5	4°	0,058	1,00	0,65	0,083	0,38	0,50
5	3°	0,052	1,00	0,55	0,075	0,38	0,40
5	2°	0,046	1,00	0,45	0,066	0,38	0,30

Abmessungen in mm
Dimensions in mm

DSTH

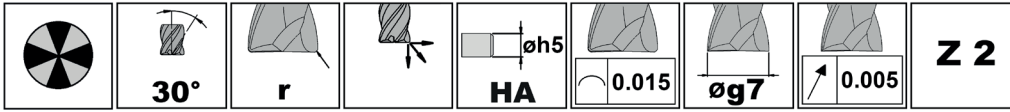

B

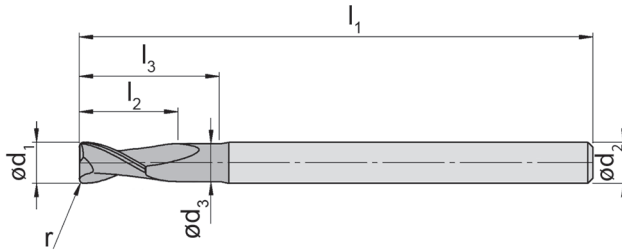

Bestellnummer Part number	d ₁	r	l ₂	l ₃	d ₃	d ₂	l ₁	Z	TS3E
DSTH.2.060.020.015	6	0,2	9	9	-	6	64	2	▲
DSTH.2.060.020.030	6	0,2	9	18	5,7	6	64	2	▲
DSTH.2.060.020.050	6	0,2	9	30	5,7	6	78	2	▲
DSTH.2.060.020.070	6	0,2	9	42	5,7	6	78	2	▲
DSTH.2.060.050.015	6	0,5	9	9	-	6	64	2	▲
DSTH.2.060.050.030	6	0,5	9	18	5,7	6	64	2	▲
DSTH.2.060.050.050	6	0,5	9	30	5,7	6	78	2	▲
DSTH.2.060.050.070	6	0,5	9	42	5,7	6	78	2	▲
DSTH.2.060.100.015	6	1,0	9	9	-	6	64	2	▲
DSTH.2.060.100.030	6	1,0	9	18	5,7	6	64	2	▲
DSTH.2.060.100.050	6	1,0	9	30	5,7	6	78	2	▲
DSTH.2.060.100.070	6	1,0	9	42	5,7	6	78	2	▲
DSTH.2.060.200.015	6	2,0	9	9	-	6	64	2	▲
DSTH.2.060.200.030	6	2,0	9	18	5,7	6	64	2	▲
DSTH.2.060.200.050	6	2,0	9	30	5,7	6	78	2	▲
DSTH.2.060.200.070	6	2,0	9	42	5,7	6	78	2	▲

▲ ab Lager / on stock Δ 4 Wochen / 4 weeks x auf Anfrage / upon request

● empfohlen / recommended

o bedingt einsetzbar / alternative recommendation

- nicht geeignet / not suitable

■ unbeschichtete HM-Sorten / uncoated grades

■ beschichtete HM-Sorten / coated grades

■ bestückt/Cermet / brazed/Cermet

Abmessungen in mm

Dimensions in mm

P	-
M	-
K	-
N	-
S	-
H	•



HM-Sorten
Carbide grades

Schnittdaten DSTH Ø 6,0 mm



Cutting Data DSTH Ø 6,0 mm

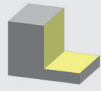

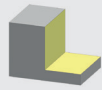

Konventionelles Fräsen / Conventional milling

		
	vc = m/min	vc = m/min
H1.1	120	150
H1.2	100	130
H1.3	80	100
H1.4	70	90

HSC Fräsen / HSC milling

		
	vc = m/min	vc = m/min
H1.1	180	220
H1.2	160	190
H1.3	140	170
H1.4	120	140

B

d ₁							
		f _z	a _e	a _p	f _z	a _e	a _p
6	5°	0,069	1,20	0,90	0,099	0,45	0,60
6	4°	0,069	1,20	0,78	0,099	0,45	0,60
6	3°	0,062	1,20	0,66	0,089	0,45	0,48
6	2°	0,055	1,20	0,54	0,079	0,45	0,36
6	5°	0,069	1,20	0,90	0,099	0,45	0,60
6	4°	0,069	1,20	0,78	0,099	0,45	0,60
6	3°	0,062	1,20	0,66	0,089	0,45	0,48
6	2°	0,055	1,20	0,54	0,079	0,45	0,36
6	5°	0,069	1,20	0,90	0,099	0,45	0,60
6	4°	0,069	1,20	0,78	0,099	0,45	0,60
6	3°	0,062	1,20	0,66	0,089	0,45	0,48
6	2°	0,055	1,20	0,54	0,079	0,45	0,36
6	5°	0,069	1,20	0,90	0,099	0,45	0,60
6	4°	0,069	1,20	0,78	0,099	0,45	0,60
6	3°	0,062	1,20	0,66	0,089	0,45	0,48
6	2°	0,055	1,20	0,54	0,079	0,45	0,36

Abmessungen in mm
Dimensions in mm

DSTH

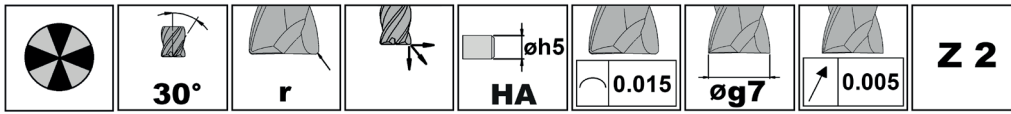

B

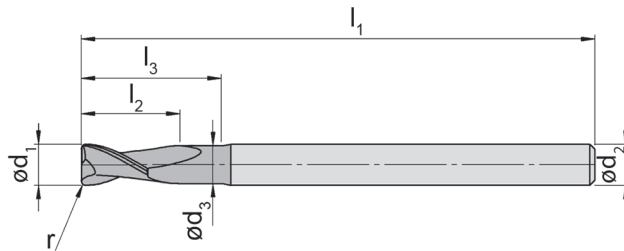

Bestellnummer Part number	d ₁	r	l ₂	l ₃	d ₃	d ₂	l ₁	Z	TS3E
DSTH.2.080.020.015	8	0,2	12	12	-	8	64	2	▲
DSTH.2.080.020.030	8	0,2	12	24	7,6	8	64	2	▲
DSTH.2.080.020.050	8	0,2	12	40	7,6	8	78	2	▲
DSTH.2.080.020.070	8	0,2	12	56	7,6	8	100	2	▲
DSTH.2.080.050.015	8	0,5	12	12	-	8	64	2	▲
DSTH.2.080.050.030	8	0,5	12	24	7,6	8	64	2	▲
DSTH.2.080.050.050	8	0,5	12	40	7,6	8	78	2	▲
DSTH.2.080.050.070	8	0,5	12	56	7,6	8	100	2	▲
DSTH.2.080.100.015	8	1,0	12	12	-	8	64	2	▲
DSTH.2.080.100.030	8	1,0	12	24	7,6	8	64	2	▲
DSTH.2.080.100.050	8	1,0	12	40	7,6	8	78	2	▲
DSTH.2.080.100.070	8	1,0	12	56	7,6	8	100	2	▲
DSTH.2.080.200.015	8	2,0	12	12	-	8	64	2	▲
DSTH.2.080.200.030	8	2,0	12	24	7,6	8	64	2	▲
DSTH.2.080.200.050	8	2,0	12	40	7,6	8	78	2	▲
DSTH.2.080.200.070	8	2,0	12	56	7,6	8	100	2	▲

▲ ab Lager / on stock Δ 4 Wochen / 4 weeks x auf Anfrage / upon request

● empfohlen / recommended

o bedingt einsetzbar / alternative recommendation

- nicht geeignet / not suitable

■ unbeschichtete HM-Sorten / uncoated grades

■ beschichtete HM-Sorten / coated grades

■ bestückt/Cermet / brazed/Cermet

Abmessungen in mm

Dimensions in mm

P	-
M	-
K	-
N	-
S	-
H	•



HM-Sorten
Carbide grades

Schnittdaten DSTH Ø 8,0 mm



Cutting Data DSTH Ø 8,0 mm



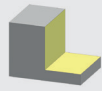

Konventionelles Fräsen / Conventional milling

		
	vc = m/min	vc = m/min
H1.1	120	150
H1.2	100	130
H1.3	80	100
H1.4	70	90

HSC Fräsen / HSC milling

		
	vc = m/min	vc = m/min
H1.1	180	220
H1.2	160	190
H1.3	140	170
H1.4	120	140

B

d ₁							
		f _z	a _e	a _p	f _z	a _e	a _p
8	5°	0,092	1,60	1,20	0,130	0,60	0,80
8	4°	0,092	1,60	1,04	0,130	0,60	0,80
8	3°	0,082	1,60	0,88	0,117	0,60	0,64
8	2°	0,073	1,60	0,72	0,104	0,60	0,48
8	5°	0,092	1,60	1,20	0,130	0,60	0,80
8	4°	0,092	1,60	1,04	0,130	0,60	0,80
8	3°	0,082	1,60	0,88	0,117	0,60	0,64
8	2°	0,073	1,60	0,72	0,104	0,60	0,48
8	5°	0,092	1,60	1,20	0,130	0,60	0,80
8	4°	0,092	1,60	1,04	0,130	0,60	0,80
8	3°	0,082	1,60	0,88	0,117	0,60	0,64
8	2°	0,073	1,60	0,72	0,104	0,60	0,48
8	5°	0,092	1,60	1,20	0,130	0,60	0,80
8	4°	0,092	1,60	1,04	0,130	0,60	0,80
8	3°	0,082	1,60	0,88	0,117	0,60	0,64
8	2°	0,073	1,60	0,72	0,104	0,60	0,48

Abmessungen in mm
Dimensions in mm

DSTH

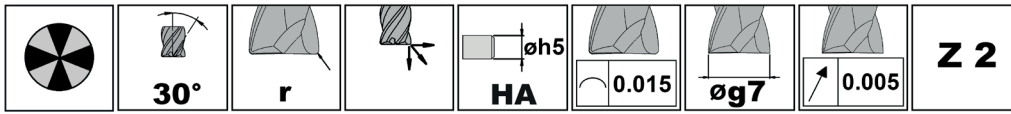

B

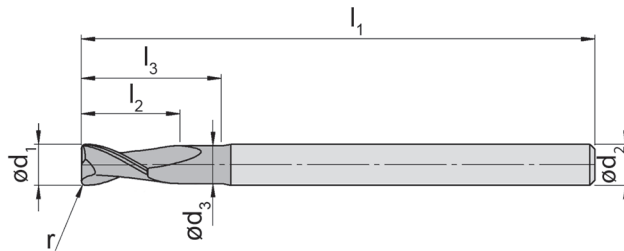

Bestellnummer Part number	d ₁	r	l ₂	l ₃	d ₃	d ₂	l ₁	Z	TS3E
DSTH.2.100.020.015	10	0,2	15	15	-	10	78	2	▲
DSTH.2.100.020.030	10	0,2	15	30	9,6	10	78	2	▲
DSTH.2.100.020.050	10	0,2	15	50	9,6	10	100	2	▲
DSTH.2.100.020.070	10	0,2	15	70	9,6	10	120	2	▲
DSTH.2.100.050.015	10	0,5	15	15	-	10	78	2	▲
DSTH.2.100.050.030	10	0,5	15	30	9,6	10	78	2	▲
DSTH.2.100.050.050	10	0,5	15	50	9,6	10	100	2	▲
DSTH.2.100.050.070	10	0,5	15	70	9,6	10	120	2	▲
DSTH.2.100.100.015	10	1,0	15	15	-	10	78	2	▲
DSTH.2.100.100.030	10	1,0	15	30	9,6	10	78	2	▲
DSTH.2.100.100.050	10	1,0	15	50	9,6	10	100	2	▲
DSTH.2.100.100.070	10	1,0	15	70	9,6	10	120	2	▲
DSTH.2.100.200.015	10	2,0	15	15	-	10	78	2	▲
DSTH.2.100.200.030	10	2,0	15	30	9,6	10	78	2	▲
DSTH.2.100.200.050	10	2,0	15	50	9,6	10	100	2	▲
DSTH.2.100.200.070	10	2,0	15	70	9,6	10	120	2	▲

▲ ab Lager / on stock Δ 4 Wochen / 4 weeks x auf Anfrage / upon request

● empfohlen / recommended

o bedingt einsetzbar / alternative recommendation

- nicht geeignet / not suitable

■ unbeschichtete HM-Sorten / uncoated grades

■ beschichtete HM-Sorten / coated grades

■ bestückt/Cermet / brazed/Cermet

Abmessungen in mm

Dimensions in mm

P	-
M	-
K	-
N	-
S	-
H	•



HM-Sorten
Carbide grades

Schnittdaten DSTH Ø 10,0 mm



Cutting Data DSTH Ø 10,0 mm

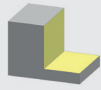

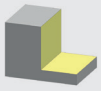

Konventionelles Fräsen / Conventional milling

		
	vc = m/min	vc = m/min
H1.1	120	150
H1.2	100	130
H1.3	80	100
H1.4	70	90

HSC Fräsen / HSC milling

		
	vc = m/min	vc = m/min
H1.1	180	220
H1.2	160	190
H1.3	140	170
H1.4	120	140

B

d ₁							
		f _z	a _e	a _p	f _z	a _e	a _p
10	5°	0,114	2,00	1,50	0,162	0,75	1,00
10	4°	0,114	2,00	1,30	0,162	0,75	1,00
10	3°	0,103	2,00	1,10	0,146	0,75	0,80
10	2°	0,091	2,00	0,90	0,130	0,75	0,60
10	5°	0,114	2,00	1,50	0,162	0,75	1,00
10	4°	0,114	2,00	1,30	0,162	0,75	1,00
10	3°	0,103	2,00	1,10	0,146	0,75	0,80
10	2°	0,091	2,00	0,90	0,130	0,75	0,60
10	5°	0,114	2,00	1,50	0,162	0,75	1,00
10	4°	0,114	2,00	1,30	0,162	0,75	1,00
10	3°	0,103	2,00	1,10	0,146	0,75	0,80
10	2°	0,091	2,00	0,90	0,130	0,75	0,60
10	5°	0,114	2,00	1,50	0,162	0,75	1,00
10	4°	0,114	2,00	1,30	0,162	0,75	1,00
10	3°	0,103	2,00	1,10	0,146	0,75	0,80
10	2°	0,091	2,00	0,90	0,130	0,75	0,60

Abmessungen in mm
Dimensions in mm

DSTH

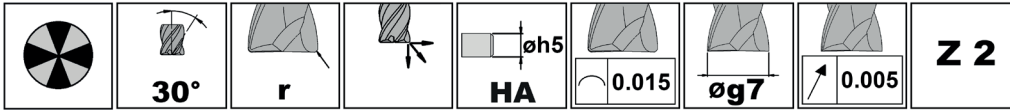

B

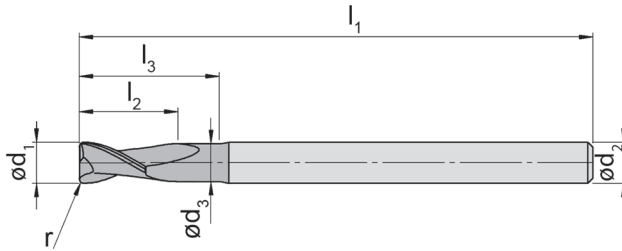

Bestellnummer Part number	d ₁	r	l ₂	l ₃	d ₃	d ₂	l ₁	Z	TS3E
DSTH.2.120.020.015	12	0,2	18	18	-	12	78	2	▲
DSTH.2.120.020.030	12	0,2	18	36	11,6	12	100	2	▲
DSTH.2.120.020.050	12	0,2	18	60	11,6	12	120	2	▲
DSTH.2.120.020.070	12	0,2	18	84	11,6	12	140	2	▲
DSTH.2.120.050.015	12	0,5	18	18	-	12	78	2	▲
DSTH.2.120.050.030	12	0,5	18	36	11,6	12	100	2	▲
DSTH.2.120.050.050	12	0,5	18	60	11,6	12	120	2	▲
DSTH.2.120.050.070	12	0,5	18	84	11,6	12	140	2	▲
DSTH.2.120.100.015	12	1,0	18	18	-	12	78	2	▲
DSTH.2.120.100.030	12	1,0	18	36	11,6	12	100	2	▲
DSTH.2.120.100.050	12	1,0	18	60	11,6	12	120	2	▲
DSTH.2.120.100.070	12	1,0	18	84	11,6	12	140	2	▲
DSTH.2.120.200.015	12	2,0	18	18	-	12	78	2	▲
DSTH.2.120.200.030	12	2,0	18	36	11,6	12	100	2	▲
DSTH.2.120.200.050	12	2,0	18	60	11,6	12	120	2	▲
DSTH.2.120.200.070	12	2,0	18	84	11,6	12	140	2	▲

▲ ab Lager / on stock Δ 4 Wochen / 4 weeks x auf Anfrage / upon request

● empfohlen / recommended

o bedingt einsetzbar / alternative recommendation

- nicht geeignet / not suitable

■ unbeschichtete HM-Sorten / uncoated grades

■ beschichtete HM-Sorten / coated grades

■ bestückt/Cermet / brazed/Cermet

Abmessungen in mm

Dimensions in mm

P	-
M	-
K	-
N	-
S	-
H	•



HM-Sorten
Carbide grades

Schnittdaten DSTH Ø 12,0 mm



Cutting Data DSTH Ø 12,0 mm

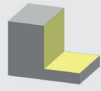

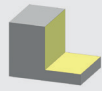

Konventionelles Fräsen / Conventional milling

		
	vc = m/min	vc = m/min
H1.1	120	150
H1.2	100	130
H1.3	80	100
H1.4	70	90

HSC Fräsen / HSC milling

		
	vc = m/min	vc = m/min
H1.1	180	220
H1.2	160	190
H1.3	140	170
H1.4	120	140

B

d ₁							
		f _z	a _e	a _p	f _z	a _e	a _p
12	5°	0,136	2,40	1,80	0,194	0,90	1,20
12	4°	0,136	2,40	1,56	0,194	0,90	1,20
12	3°	0,123	2,40	1,32	0,175	0,90	0,96
12	2°	0,109	2,40	1,08	0,155	0,90	0,72
12	5°	0,136	2,40	1,80	0,194	0,90	1,20
12	4°	0,136	2,40	1,56	0,194	0,90	1,20
12	3°	0,123	2,40	1,32	0,175	0,90	0,96
12	2°	0,109	2,40	1,08	0,155	0,90	0,72
12	5°	0,136	2,40	1,80	0,194	0,90	1,20
12	4°	0,136	2,40	1,56	0,194	0,90	1,20
12	3°	0,123	2,40	1,32	0,175	0,90	0,96
12	2°	0,109	2,40	1,08	0,155	0,90	0,72
12	5°	0,136	2,40	1,80	0,194	0,90	1,20
12	4°	0,136	2,40	1,56	0,194	0,90	1,20
12	3°	0,123	2,40	1,32	0,175	0,90	0,96
12	2°	0,109	2,40	1,08	0,155	0,90	0,72

Abmessungen in mm
Dimensions in mm

DSTH

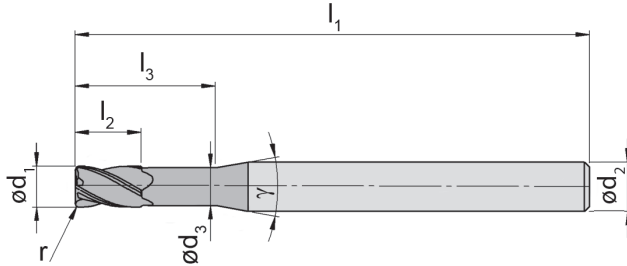
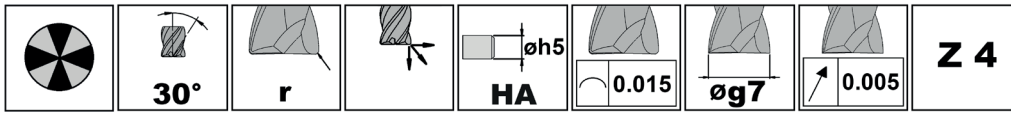

B

Bestellnummer Part number	d ₁	r	l ₂	l ₃	d ₃	d ₂	l ₁	Z	γ	TS3E
DSTH.4.040.020.015	4	0,2	6,0	6,0	-	6	64	4	20°	▲
DSTH.4.040.020.030	4	0,2	6,0	12,0	3,8	6	64	4	20°	▲
DSTH.4.040.020.050	4	0,2	6,0	20,0	3,8	6	64	4	20°	▲
DSTH.4.040.020.070	4	0,2	6,0	28,0	3,8	6	78	4	20°	▲
DSTH.4.040.050.015	4	0,5	6,0	6,0	-	6	64	4	20°	▲
DSTH.4.040.050.030	4	0,5	6,0	12,0	3,8	6	64	4	20°	▲
DSTH.4.040.050.050	4	0,5	6,0	20,0	3,8	6	64	4	20°	▲
DSTH.4.040.050.070	4	0,5	6,0	28,0	3,8	6	78	4	20°	▲
DSTH.4.040.100.015	4	1,0	6,0	6,0	-	6	64	4	20°	▲
DSTH.4.040.100.030	4	1,0	6,0	12,0	3,8	6	64	4	20°	▲
DSTH.4.040.100.050	4	1,0	6,0	20,0	3,8	6	64	4	20°	▲
DSTH.4.040.100.070	4	1,0	6,0	28,0	3,8	6	78	4	20°	▲
DSTH.4.050.020.015	5	0,2	7,5	7,5	-	6	64	4	20°	▲
DSTH.4.050.020.030	5	0,2	7,5	15,0	4,7	6	64	4	20°	▲
DSTH.4.050.020.050	5	0,2	7,5	25,0	4,7	6	64	4	20°	▲
DSTH.4.050.020.070	5	0,2	7,5	35,0	4,7	6	78	4	20°	▲
DSTH.4.050.050.015	5	0,5	7,5	7,5	-	6	64	4	20°	▲
DSTH.4.050.050.030	5	0,5	7,5	15,0	4,7	6	64	4	20°	▲
DSTH.4.050.050.050	5	0,5	7,5	25,0	4,7	6	64	4	20°	▲
DSTH.4.050.050.070	5	0,5	7,5	35,0	4,7	6	78	4	20°	▲
DSTH.4.050.100.015	5	1,0	7,5	7,5	-	6	64	4	20°	▲
DSTH.4.050.100.030	5	1,0	7,5	15,0	4,7	6	64	4	20°	▲
DSTH.4.050.100.050	5	1,0	7,5	25,0	4,7	6	64	4	20°	▲
DSTH.4.050.100.070	5	1,0	7,5	35,0	4,7	6	78	4	20°	▲

▲ ab Lager / on stock Δ 4 Wochen / 4 weeks x auf Anfrage / upon request

● empfohlen / recommended

o bedingt einsetzbar / alternative recommendation

- nicht geeignet / not suitable

■ unbeschichtete HM-Sorten / uncoated grades

■ beschichtete HM-Sorten / coated grades

■ bestückt/Cermet / brazed/Cermet

Abmessungen in mm

Dimensions in mm

P	-
M	-
K	-
N	-
S	-
H	●



HM-Sorten
Carbide grades

Schnittdaten DSTH Ø 4,0 - 5,0 mm



Cutting Data DSTH Ø 4,0 - 5,0 mm

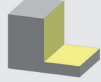

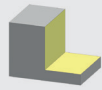

Konventionelles Fräsen / Conventional milling

		
	vc = m/min	vc = m/min
H1.1	120	150
H1.2	100	130
H1.3	80	100
H1.4	70	90

HSC Fräsen / HSC milling

		
	vc = m/min	vc = m/min
H1.1	180	220
H1.2	160	190
H1.3	140	170
H1.4	120	140

B

d ₁							
		f _z	a _e	a _p	f _z	a _e	a _p
4	5°	0,019	0,80	0,60	0,022	0,30	0,40
4	4°	0,019	0,80	0,52	0,022	0,30	0,40
4	3°	0,017	0,80	0,44	0,020	0,30	0,32
4	2°	0,015	0,80	0,36	0,018	0,30	0,24
4	5°	0,019	0,80	0,60	0,022	0,30	0,40
4	4°	0,019	0,80	0,52	0,022	0,30	0,40
4	3°	0,017	0,80	0,44	0,020	0,30	0,32
4	2°	0,015	0,80	0,36	0,018	0,30	0,24
4	5°	0,019	0,80	0,60	0,022	0,30	0,40
4	4°	0,019	0,80	0,52	0,022	0,30	0,40
4	3°	0,017	0,80	0,44	0,020	0,30	0,32
4	2°	0,015	0,80	0,36	0,018	0,30	0,24
5	5°	0,030	1,00	0,75	0,038	0,38	0,50
5	4°	0,030	1,00	0,65	0,038	0,38	0,50
5	3°	0,027	1,00	0,55	0,034	0,38	0,40
5	2°	0,024	1,00	0,45	0,030	0,38	0,30
5	5°	0,030	1,00	0,75	0,038	0,38	0,50
5	4°	0,030	1,00	0,65	0,038	0,38	0,50
5	3°	0,027	1,00	0,55	0,034	0,38	0,40
5	2°	0,024	1,00	0,45	0,030	0,38	0,30
5	5°	0,030	1,00	0,75	0,038	0,38	0,50
5	4°	0,030	1,00	0,65	0,038	0,38	0,50
5	3°	0,027	1,00	0,55	0,034	0,38	0,40
5	2°	0,024	1,00	0,45	0,030	0,38	0,30

Abmessungen in mm
Dimensions in mm

DSTH

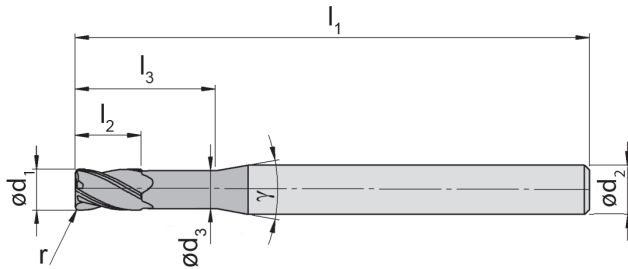
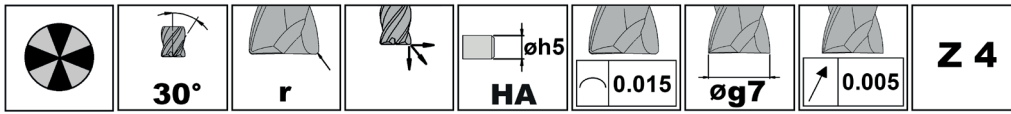

B

Bestellnummer Part number	d ₁	r	l ₂	l ₃	d ₃	d ₂	l ₁	Z	TS3E
DSTH.4.060.020.015	6	0,2	9	9	-	6	64	4	▲
DSTH.4.060.020.030	6	0,2	9	18	5,7	6	64	4	▲
DSTH.4.060.020.050	6	0,2	9	30	5,7	6	78	4	▲
DSTH.4.060.020.070	6	0,2	9	42	5,7	6	78	4	▲
DSTH.4.060.050.015	6	0,5	9	9	-	6	64	4	▲
DSTH.4.060.050.030	6	0,5	9	18	5,7	6	64	4	▲
DSTH.4.060.050.050	6	0,5	9	30	5,7	6	78	4	▲
DSTH.4.060.050.070	6	0,5	9	42	5,7	6	78	4	▲
DSTH.4.060.100.015	6	1,0	9	9	-	6	64	4	▲
DSTH.4.060.100.030	6	1,0	9	18	5,7	6	64	4	▲
DSTH.4.060.100.050	6	1,0	9	30	5,7	6	78	4	▲
DSTH.4.060.100.070	6	1,0	9	42	5,7	6	78	4	▲
DSTH.4.060.200.015	6	2,0	9	9	-	6	64	4	▲
DSTH.4.060.200.030	6	2,0	9	18	5,7	6	64	4	▲
DSTH.4.060.200.050	6	2,0	9	30	5,7	6	78	4	▲
DSTH.4.060.200.070	6	2,0	9	42	5,7	6	78	4	▲

▲ ab Lager / on stock Δ 4 Wochen / 4 weeks x auf Anfrage / upon request

● empfohlen / recommended

o bedingt einsetzbar / alternative recommendation

- nicht geeignet / not suitable

■ unbeschichtete HM-Sorten / uncoated grades

■ beschichtete HM-Sorten / coated grades

■ bestückt/Cermet / brazed/Cermet

Abmessungen in mm

Dimensions in mm

P	-
M	-
K	-
N	-
S	-
H	•



HM-Sorten
Carbide grades

Schnittdaten DSTH Ø 6,0 mm



Cutting Data DSTH Ø 6,0 mm

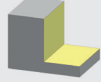



Konventionelles Fräsen / Conventional milling

		
	vc = m/min	vc = m/min
H1.1	120	150
H1.2	100	130
H1.3	80	100
H1.4	70	90

HSC Fräsen / HSC milling

		
	vc = m/min	vc = m/min
H1.1	180	220
H1.2	160	190
H1.3	140	170
H1.4	120	140

B

d ₁							
		f _z	a _e	a _p	f _z	a _e	a _p
6	5°	0,040	1,20	0,90	0,053	0,45	0,60
6	4°	0,040	1,20	0,78	0,053	0,45	0,60
6	3°	0,036	1,20	0,66	0,048	0,45	0,48
6	2°	0,032	1,20	0,54	0,042	0,45	0,36
6	5°	0,040	1,20	0,90	0,053	0,45	0,60
6	4°	0,040	1,20	0,78	0,053	0,45	0,60
6	3°	0,036	1,20	0,66	0,048	0,45	0,48
6	2°	0,032	1,20	0,54	0,042	0,45	0,36
6	5°	0,040	1,20	0,90	0,053	0,45	0,60
6	4°	0,040	1,20	0,78	0,053	0,45	0,60
6	3°	0,036	1,20	0,66	0,048	0,45	0,48
6	2°	0,032	1,20	0,54	0,042	0,45	0,36
6	5°	0,040	1,20	0,90	0,053	0,45	0,60
6	4°	0,040	1,20	0,78	0,053	0,45	0,60
6	3°	0,036	1,20	0,66	0,048	0,45	0,48
6	2°	0,032	1,20	0,54	0,042	0,45	0,36

Abmessungen in mm
Dimensions in mm

DSTH

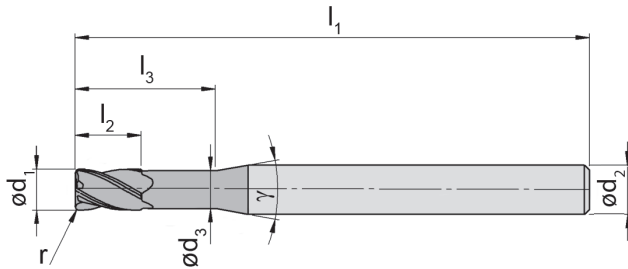
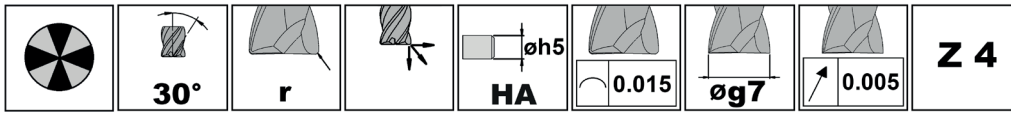

B

Bestellnummer Part number	d ₁	r	l ₂	l ₃	d ₃	d ₂	l ₁	Z	TS3E
DSTH.4.080.020.015	8	0,2	12	12	-	8	64	4	▲
DSTH.4.080.020.030	8	0,2	12	24	7,6	8	64	4	▲
DSTH.4.080.020.050	8	0,2	12	40	7,6	8	78	4	▲
DSTH.4.080.020.070	8	0,2	12	56	7,6	8	100	4	▲
DSTH.4.080.050.015	8	0,5	12	12	-	8	64	4	▲
DSTH.4.080.050.030	8	0,5	12	24	7,6	8	64	4	▲
DSTH.4.080.050.050	8	0,5	12	40	7,6	8	78	4	▲
DSTH.4.080.050.070	8	0,5	12	56	7,6	8	100	4	▲
DSTH.4.080.100.015	8	1,0	12	12	-	8	64	4	▲
DSTH.4.080.100.030	8	1,0	12	24	7,6	8	64	4	▲
DSTH.4.080.100.050	8	1,0	12	40	7,6	8	78	4	▲
DSTH.4.080.100.070	8	1,0	12	56	7,6	8	100	4	▲
DSTH.4.080.200.015	8	2,0	12	12	-	8	64	4	▲
DSTH.4.080.200.030	8	2,0	12	24	7,6	8	64	4	▲
DSTH.4.080.200.050	8	2,0	12	40	7,6	8	78	4	▲
DSTH.4.080.200.070	8	2,0	12	56	7,6	8	100	4	▲

▲ ab Lager / on stock Δ 4 Wochen / 4 weeks x auf Anfrage / upon request

● empfohlen / recommended

o bedingt einsetzbar / alternative recommendation

- nicht geeignet / not suitable

■ unbeschichtete HM-Sorten / uncoated grades

■ beschichtete HM-Sorten / coated grades

■ bestückt/Cermet / brazed/Cermet

Abmessungen in mm

Dimensions in mm

P	-
M	-
K	-
N	-
S	-
H	•



HM-Sorten
Carbide grades

Schnittdaten DSTH Ø 8,0 mm



Cutting Data DSTH Ø 8,0 mm

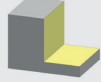

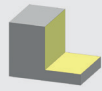

Konventionelles Fräsen / Conventional milling

		
	vc = m/min	vc = m/min
H1.1	120	150
H1.2	100	130
H1.3	80	100
H1.4	70	90

HSC Fräsen / HSC milling

		
	vc = m/min	vc = m/min
H1.1	180	220
H1.2	160	190
H1.3	140	170
H1.4	120	140

B

d ₁							
		f _z	a _e	a _p	f _z	a _e	a _p
8	5°	0,060	1,60	1,20	0,083	0,60	0,80
8	4°	0,060	1,60	1,04	0,083	0,60	0,80
8	3°	0,054	1,60	0,88	0,075	0,60	0,64
8	2°	0,048	1,60	0,72	0,067	0,60	0,48
8	5°	0,060	1,60	1,20	0,083	0,60	0,80
8	4°	0,060	1,60	1,04	0,083	0,60	0,80
8	3°	0,054	1,60	0,88	0,075	0,60	0,64
8	2°	0,048	1,60	0,72	0,067	0,60	0,48
8	5°	0,060	1,60	1,20	0,083	0,60	0,80
8	4°	0,060	1,60	1,04	0,083	0,60	0,80
8	3°	0,054	1,60	0,88	0,075	0,60	0,64
8	2°	0,048	1,60	0,72	0,067	0,60	0,48
8	5°	0,060	1,60	1,20	0,083	0,60	0,80
8	4°	0,060	1,60	1,04	0,083	0,60	0,80
8	3°	0,054	1,60	0,88	0,075	0,60	0,64
8	2°	0,048	1,60	0,72	0,067	0,60	0,48

Abmessungen in mm
Dimensions in mm

DSTH

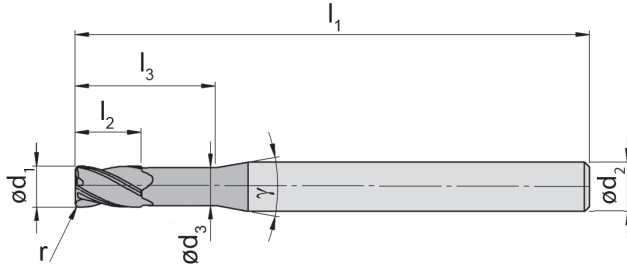
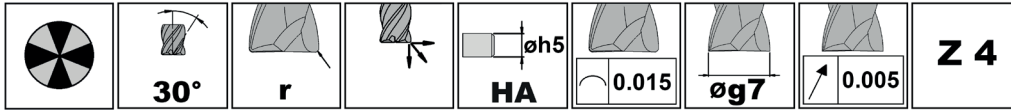

B

Bestellnummer Part number	d ₁	r	l ₂	l ₃	d ₃	d ₂	l ₁	Z	TS3E
DSTH.4.100.020.015	10	0,2	15	15	-	10	78	4	▲
DSTH.4.100.020.030	10	0,2	15	30	9,6	10	78	4	▲
DSTH.4.100.020.050	10	0,2	15	50	9,6	10	100	4	▲
DSTH.4.100.020.070	10	0,2	15	70	9,6	10	120	4	▲
DSTH.4.100.050.015	10	0,5	15	15	-	10	78	4	▲
DSTH.4.100.050.030	10	0,5	15	30	9,6	10	78	4	▲
DSTH.4.100.050.050	10	0,5	15	50	9,6	10	100	4	▲
DSTH.4.100.050.070	10	0,5	15	70	9,6	10	120	4	▲
DSTH.4.100.100.015	10	1,0	15	15	-	10	78	4	▲
DSTH.4.100.100.030	10	1,0	15	30	9,6	10	78	4	▲
DSTH.4.100.100.050	10	1,0	15	50	9,6	10	100	4	▲
DSTH.4.100.100.070	10	1,0	15	70	9,6	10	120	4	▲
DSTH.4.100.200.015	10	2,0	15	15	-	10	78	4	▲
DSTH.4.100.200.030	10	2,0	15	30	9,6	10	78	4	▲
DSTH.4.100.200.050	10	2,0	15	50	9,6	10	100	4	▲
DSTH.4.100.200.070	10	2,0	15	70	9,6	10	120	4	▲

▲ ab Lager / on stock Δ 4 Wochen / 4 weeks x auf Anfrage / upon request

● empfohlen / recommended

o bedingt einsetzbar / alternative recommendation

- nicht geeignet / not suitable

■ unbeschichtete HM-Sorten / uncoated grades

■ beschichtete HM-Sorten / coated grades

■ bestückt/Cermet / brazed/Cermet

Abmessungen in mm

Dimensions in mm

P	-
M	-
K	-
N	-
S	-
H	•



HM-Sorten
Carbide grades

Schnittdaten DSTH Ø 10,0 mm



Cutting Data DSTH Ø 10,0 mm

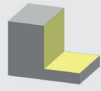

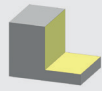

Konventionelles Fräsen / Conventional milling

		
	vc = m/min	vc = m/min
H1.1	120	150
H1.2	100	130
H1.3	80	100
H1.4	70	90

HSC Fräsen / HSC milling

		
	vc = m/min	vc = m/min
H1.1	180	220
H1.2	160	190
H1.3	140	170
H1.4	120	140

B

d ₁							
		f _z	a _e	a _p	f _z	a _e	a _p
10	5°	0,080	2,00	1,50	0,114	0,75	1,00
10	4°	0,080	2,00	1,30	0,114	0,75	1,00
10	3°	0,072	2,00	1,10	0,102	0,75	0,80
10	2°	0,064	2,00	0,90	0,091	0,75	0,60
10	5°	0,080	2,00	1,50	0,114	0,75	1,00
10	4°	0,080	2,00	1,30	0,114	0,75	1,00
10	3°	0,072	2,00	1,10	0,102	0,75	0,80
10	2°	0,064	2,00	0,90	0,091	0,75	0,60
10	5°	0,080	2,00	1,50	0,114	0,75	1,00
10	4°	0,080	2,00	1,30	0,114	0,75	1,00
10	3°	0,072	2,00	1,10	0,102	0,75	0,80
10	2°	0,064	2,00	0,90	0,091	0,75	0,60
10	5°	0,080	2,00	1,50	0,114	0,75	1,00
10	4°	0,080	2,00	1,30	0,114	0,75	1,00
10	3°	0,072	2,00	1,10	0,102	0,75	0,80
10	2°	0,064	2,00	0,90	0,091	0,75	0,60

Abmessungen in mm
Dimensions in mm

DSTH

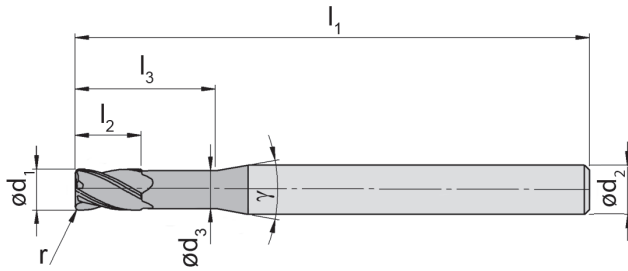
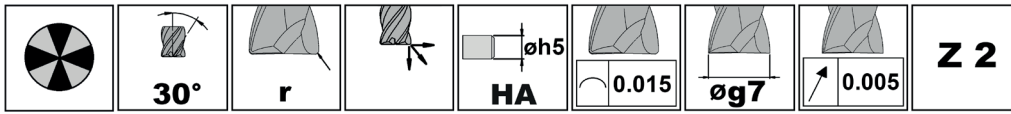

B

Bestellnummer Part number	d ₁	r	l ₂	l ₃	d ₃	d ₂	l ₁	Z	TS3E
DSTH.4.120.020.015	12	0,2	18	18	-	12	78	4	▲
DSTH.4.120.020.030	12	0,2	18	36	11,6	12	100	4	▲
DSTH.4.120.020.050	12	0,2	18	60	11,6	12	120	4	▲
DSTH.4.120.020.070	12	0,2	18	84	11,6	12	140	4	▲
DSTH.4.120.050.015	12	0,5	18	18	-	12	78	4	▲
DSTH.4.120.050.030	12	0,5	18	36	11,6	12	100	4	▲
DSTH.4.120.050.050	12	0,5	18	60	11,6	12	120	4	▲
DSTH.4.120.050.070	12	0,5	18	84	11,6	12	140	4	▲
DSTH.4.120.100.015	12	1,0	18	18	-	12	78	4	▲
DSTH.4.120.100.030	12	1,0	18	36	11,6	12	100	4	▲
DSTH.4.120.100.050	12	1,0	18	60	11,6	12	120	4	▲
DSTH.4.120.100.070	12	1,0	18	84	11,6	12	140	4	▲
DSTH.4.120.200.015	12	2,0	18	18	-	12	78	4	▲
DSTH.4.120.200.030	12	2,0	18	36	11,6	12	100	4	▲
DSTH.4.120.200.050	12	2,0	18	60	11,6	12	120	4	▲
DSTH.4.120.200.070	12	2,0	18	84	11,6	12	140	4	▲

▲ ab Lager / on stock Δ 4 Wochen / 4 weeks x auf Anfrage / upon request

● empfohlen / recommended

o bedingt einsetzbar / alternative recommendation

- nicht geeignet / not suitable

■ unbeschichtete HM-Sorten / uncoated grades

■ beschichtete HM-Sorten / coated grades

■ bestückt/Cermet / brazed/Cermet

Abmessungen in mm

Dimensions in mm

P	-
M	-
K	-
N	-
S	-
H	•



HM-Sorten
Carbide grades

Schnittdaten DSTH Ø 12,0 mm



Cutting Data DSTH Ø 12,0 mm



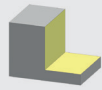

Konventionelles Fräsen / Conventional milling

		
	vc = m/min	vc = m/min
H1.1	120	150
H1.2	100	130
H1.3	80	100
H1.4	70	90

HSC Fräsen / HSC milling

		
	vc = m/min	vc = m/min
H1.1	180	220
H1.2	160	190
H1.3	140	170
H1.4	120	140

B

d ₁							
		f _z	a _e	a _p	f _z	a _e	a _p
12	5°	0,101	2,40	1,80	0,144	0,90	1,20
12	4°	0,101	2,40	1,56	0,144	0,90	1,20
12	3°	0,091	2,40	1,32	0,130	0,90	0,96
12	2°	0,081	2,40	1,08	0,115	0,90	0,72
12	5°	0,101	2,40	1,80	0,144	0,90	1,20
12	4°	0,101	2,40	1,56	0,144	0,90	1,20
12	3°	0,091	2,40	1,32	0,130	0,90	0,96
12	2°	0,081	2,40	1,08	0,115	0,90	0,72
12	5°	0,101	2,40	1,80	0,144	0,90	1,20
12	4°	0,101	2,40	1,56	0,144	0,90	1,20
12	3°	0,091	2,40	1,32	0,130	0,90	0,96
12	2°	0,081	2,40	1,08	0,115	0,90	0,72
12	5°	0,101	2,40	1,80	0,144	0,90	1,20
12	4°	0,101	2,40	1,56	0,144	0,90	1,20
12	3°	0,091	2,40	1,32	0,130	0,90	0,96
12	2°	0,081	2,40	1,08	0,115	0,90	0,72

Abmessungen in mm
Dimensions in mm

Schaftfräser Mehrschneider

End Mill multiple fluted



DSMH

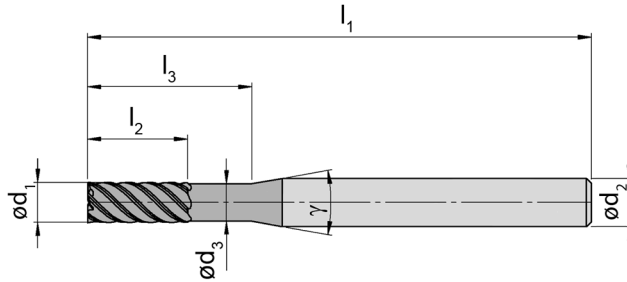
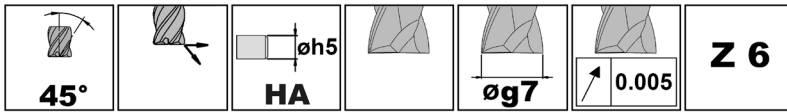

Bis Ø 3 mm vormontiert lieferbar für Toodle Schnelllaufspindel
Pre-assembled available up to Ø 3 mm for Toodle high-speed spindle

Bestellnummer Part number	d ₁	l ₂	l ₃	d ₃	d ₂	l ₁	Z	γ	TS3E
DSMH.6.03.040	3	7,5	12	2,86	6	64	6	20°	▲
DSMH.6.04.040	4	10,0	16	3,80	6	64	6	20°	▲
DSMH.6.05.040	5	12,5	20	4,70	6	64	6	20°	▲
DSMH.6.06.040	6	15,0	24	5,70	6	64	6	-°	▲
DSMH.6.08.040	8	20,0	32	7,60	8	78	6	-°	▲
DSMH.6.10.040	10	25,0	40	9,40	10	78	6	-°	▲
DSMH.6.12.040	12	30,0	48	11,40	12	100	6	-°	▲
DSMH.6.16.040	16	40,0	64	15,40	16	120	6	-°	▲

▲ ab Lager / on stock Δ 4 Wochen / 4 weeks x auf Anfrage / upon request

● empfohlen / recommended

o bedingt einsetzbar / alternative recommendation

- nicht geeignet / not suitable

□ unbeschichtete HM-Sorten / uncoated grades

■ beschichtete HM-Sorten / coated grades

■ bestückt/Cermet / brazed/Cermet

Abmessungen in mm

Dimensions in mm



P	-
M	-
K	-
N	-
S	-
H	•



HM-Sorten
Carbide grades

Schnittdaten DSMH Ø 3,0 -16,0 mm

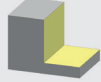
Cutting Data DSMH Ø 3,0 - 16,0 mm



	 vc = m/min	 vc = m/min
H1.1	120	150
H1.2	100	130
H1.3	80	100
H1.4	70	90

d_1							
		f_z	a_e	a_p	f_z	a_e	a_p
3	2°	0,009	0,30	6,00	0,009	0,06	6,00
4	2°	0,016	0,40	8,00	0,019	0,08	8,00
5	2°	0,022	0,50	10,00	0,029	0,10	10,00
6	2°	0,028	0,60	12,00	0,039	0,12	12,00
8	2°	0,041	0,80	16,00	0,059	0,16	16,00
10	2°	0,054	1,00	20,00	0,080	0,20	20,00
12	2°	0,066	1,20	24,00	0,100	0,24	24,00
16	2°	0,092	1,60	32,00	0,140	0,32	32,00

Abmessungen in mm
Dimensions in mm

B

Schaftfräser Mehrschneider, Radius

End Mill multiple fluted, radius



DSMRH

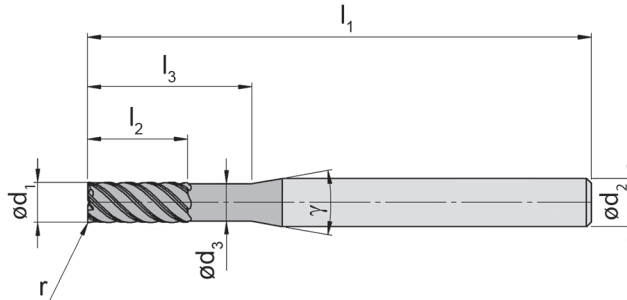
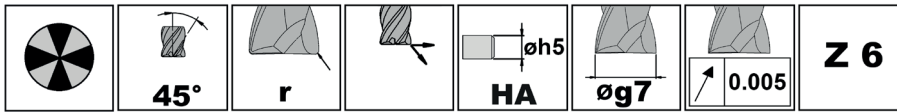

Bis Ø 3 mm vormontiert lieferbar für Toodle Schnelllaufspindel
Pre-assembled available up to Ø 3 mm for Toodle high-speed spindle

Bestellnummer Part number	d ₁	r	l ₂	l ₃	d ₃	d ₂	l ₁	Z	γ	TS3E
DSMRH.6.03.020.040	3	0,2	7,5	12	2,86	6	64	6	20°	▲
DSMRH.6.03.050.040	3	0,5	7,5	12	2,86	6	64	6	20°	▲
DSMRH.6.03.100.040	3	1,0	7,5	12	2,86	6	64	6	20°	▲
DSMRH.6.04.020.040	4	0,2	10,0	16	3,80	6	64	6	20°	▲
DSMRH.6.04.050.040	4	0,5	10,0	16	3,80	6	64	6	20°	▲
DSMRH.6.04.100.040	4	1,0	10,0	16	3,80	6	64	6	20°	▲
DSMRH.6.05.020.040	5	0,2	12,5	20	4,70	6	64	6	20°	▲
DSMRH.6.05.050.040	5	0,5	12,5	20	4,70	6	64	6	20°	▲
DSMRH.6.05.100.040	5	1,0	12,5	20	4,70	6	64	6	20°	▲
DSMRH.6.06.020.040	6	0,2	15,0	24	5,70	6	64	6	-°	▲
DSMRH.6.06.050.040	6	0,5	15,0	24	5,70	6	64	6	-°	▲
DSMRH.6.06.100.040	6	1,0	15,0	24	5,70	6	64	6	-°	▲
DSMRH.6.08.020.040	8	0,2	20,0	32	7,60	8	78	6	-°	▲
DSMRH.6.08.050.040	8	0,5	20,0	32	7,60	8	78	6	-°	▲
DSMRH.6.08.100.040	8	1,0	20,0	32	7,60	8	78	6	-°	▲
DSMRH.6.10.020.040	10	0,2	25,0	40	9,40	10	78	6	-°	▲
DSMRH.6.10.050.040	10	0,5	25,0	40	9,40	10	78	6	-°	▲
DSMRH.6.10.100.040	10	1,0	25,0	40	9,40	10	78	6	-°	▲
DSMRH.6.10.200.040	10	2,0	25,0	40	9,40	10	78	6	-°	▲
DSMRH.6.12.020.040	12	0,2	30,0	48	11,40	12	100	6	-°	▲
DSMRH.6.12.050.040	12	0,5	30,0	48	11,40	12	100	6	-°	▲
DSMRH.6.12.100.040	12	1,0	30,0	48	11,40	12	100	6	-°	▲
DSMRH.6.12.200.040	12	2,0	30,0	48	11,40	12	100	6	-°	▲

▲ ab Lager / on stock Δ 4 Wochen / 4 weeks x auf Anfrage / upon request

● empfohlen / recommended

o bedingt einsetzbar / alternative recommendation

- nicht geeignet / not suitable

■ unbeschichtete HM-Sorten / uncoated grades

■ beschichtete HM-Sorten / coated grades

■ bestückt/Cermet / brazed/Cermet

Abmessungen in mm

Dimensions in mm

P	-
M	-
K	-
N	-
S	-
H	•



HM-Sorten
Carbide grades

Schnittdaten DSMRH Ø 3,0 - 12,0 mm

Cutting Data DSMH Ø 3,0 - 12,0 mm

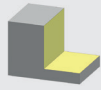
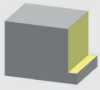

		
	vc = m/min	vc = m/min
H1.1	120	150
H1.2	100	130
H1.3	80	100
H1.4	70	90

d ₁							
		f _z	a _e	a _p	f _z	a _e	a _p
3	2°	0,009	0,30	6,00	0,009	0,06	6,00
3	2°	0,009	0,30	6,00	0,009	0,06	6,00
3	2°	0,009	0,30	6,00	0,009	0,06	6,00
4	2°	0,016	0,40	8,00	0,019	0,08	8,00
4	2°	0,016	0,40	8,00	0,019	0,08	8,00
4	2°	0,016	0,40	8,00	0,019	0,08	8,00
5	2°	0,022	0,50	10,00	0,029	0,10	10,00
5	2°	0,022	0,50	10,00	0,029	0,10	10,00
5	2°	0,022	0,50	10,00	0,029	0,10	10,00
6	2°	0,028	0,60	12,00	0,039	0,12	12,00
6	2°	0,028	0,60	12,00	0,039	0,12	12,00
6	2°	0,028	0,60	12,00	0,039	0,12	12,00
8	2°	0,041	0,80	16,00	0,059	0,16	16,00
8	2°	0,041	0,80	16,00	0,059	0,16	16,00
8	2°	0,041	0,80	16,00	0,059	0,16	16,00
10	2°	0,054	1,00	20,00	0,080	0,20	20,00
10	2°	0,054	1,00	20,00	0,080	0,20	20,00
10	2°	0,054	1,00	20,00	0,080	0,20	20,00
10	2°	0,054	1,00	20,00	0,080	0,20	20,00
12	2°	0,066	1,20	24,00	0,100	0,24	24,00
12	2°	0,066	1,20	24,00	0,100	0,24	24,00
12	2°	0,066	1,20	24,00	0,100	0,24	24,00
12	2°	0,066	1,20	24,00	0,100	0,24	24,00

Abmessungen in mm
Dimensions in mm

B

Vollhartmetall-Schaftfräser

Solid Carbide End Mills



DSKC

Schaftfräser Vollradius
Ball Nose End Mill

Ø 1,0 – Ø 16,0

Z2-Z7

B118 – B119



DSKC.220°

Schaftfräser Vollradius
Ball Nose End Mill

Ø 3,0 – Ø 12,0

Z2-Z7

B120 – B121



DSTC

Torusfräser
Torus End Mill

Ø 1,5 – Ø 12,0

Z2-Z5

B122 – B123

B



DSMRC

Schaftfräser Mehrschneider
End Mill multiple fluted

Ø 3,0 – Ø 16,0

Z2-Z5

B124 – B125

DS



B

abgestimmt für:

- Kobalt-Chrom-Stähle

designed for:

- Cobalt Chromium Steels

Schaftfräser Vollradius

Ball Nose End Mill



DSKC

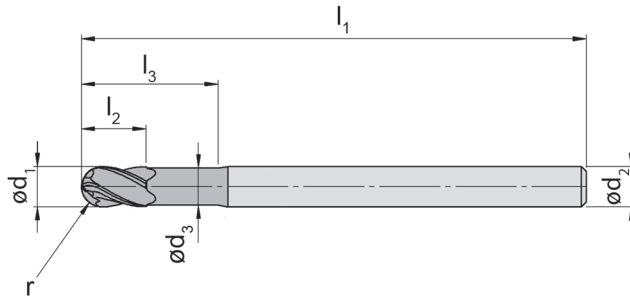
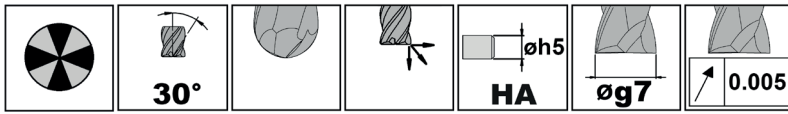

Bis Ø 3 mm vormontiert lieferbar für Toodle Schnelllaufspindel
Pre-assembled available up to Ø 3 mm for Toodle high-speed spindle

Bestellnummer Part number	d ₁	r	l ₂	l ₃	d ₃	d ₂	l ₁	Z	TSCC
DSKC.2.010.063.06	1,0	0,50	2	3,0	0,9	6	63	2	▲
DSKC.2.015.063.06	1,5	0,75	2	4,5	1,4	6	63	2	▲
DSKC.2.020.063.06	2,0	1,00	3	5,0	1,9	6	63	2	▲
DSKC.2.020.077.06	2,0	1,00	3	8,0	1,9	6	77	2	▲
DSKC.2.030.063.06	3,0	1,50	4	7,5	2,9	6	63	2	▲
DSKC.2.030.077.06	3,0	1,50	4	12,0	2,9	6	77	2	▲
DSKC.3.040.063.06	4,0	2,00	5	10,0	3,8	6	63	3	▲
DSKC.3.040.077.06	4,0	2,00	5	16,0	3,8	6	77	3	▲
DSKC.4.050.063.06	5,0	2,50	5	12,5	4,7	6	63	4	▲
DSKC.4.050.077.06	5,0	2,50	5	20,0	4,7	6	77	4	▲
DSKC.4.060.063.06	6,0	3,00	6	15,0	5,6	6	63	4	▲
DSKC.4.060.077.06	6,0	3,00	6	24,0	5,6	6	77	4	▲
DSKC.4.060.099.08	6,0	3,00	6	36,0	5,6	8	99	4	▲
DSKC.5.080.063.08	8,0	4,00	8	20,0	7,4	8	63	5	▲
DSKC.5.080.077.08	8,0	4,00	8	32,0	7,4	8	77	5	▲
DSKC.5.080.099.08	8,0	4,00	8	48,0	7,4	8	99	5	▲
DSKC.5.100.077.10	10,0	5,00	10	25,0	9,4	10	77	5	▲
DSKC.5.100.099.10	10,0	5,00	10	40,0	9,4	10	99	5	▲
DSKC.7.120.077.12	12,0	6,00	12	30,0	11,4	12	77	7	▲
DSKC.7.120.099.12	12,0	6,00	12	48,0	11,4	12	99	7	▲
DSKC.7.160.099.16	16,0	8,00	20	50,0	15,4	16	99	7	▲

▲ ab Lager / on stock Δ 4 Wochen / 4 weeks x auf Anfrage / upon request

● empfohlen / recommended

o bedingt einsetzbar / alternative recommendation

- nicht geeignet / not suitable

■ unbeschichtete HM-Sorten / uncoated grades

■ beschichtete HM-Sorten / coated grades

■ bestückt/Cermet / brazed/Cermet

Abmessungen in mm

Dimensions in mm



P	-
M	-
K	-
N	-
S	•
H	o



HM-Sorten
Carbide grades

Schnittdaten DSKC Ø 1,0 - 16,0 mm

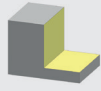
Cutting Data DSKC Ø 1,0 - 16,0 mm

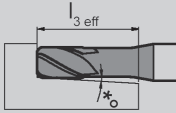

	 $vc = m/min$	 $vc = m/min$
S1	-	-
S2	45	60
S3	40	50

d_1	 α	 $l_{3\text{eff}}$ l_{*o}						
			f_z	a_e	a_p	f_z	a_e	a_p
1,0	5°	0,3	0,011	0,20	0,50	0,017	0,05	0,10
1,5	5°	0,3	0,013	0,30	0,75	0,022	0,08	0,15
2,0	5°	0,3	0,015	0,40	1,00	0,026	0,10	0,20
2,0	5°	0,3	0,015	0,40	1,00	0,026	0,10	0,20
3,0	5°	0,3	0,020	0,60	1,50	0,035	0,15	0,30
3,0	5°	0,3	0,020	0,60	1,50	0,035	0,15	0,30
4,0	5°	0,3	0,018	0,80	2,00	0,032	0,20	0,40
4,0	5°	0,3	0,018	0,80	2,00	0,032	0,20	0,40
5,0	4°	0,3	0,020	1,00	2,50	0,035	0,25	0,50
5,0	4°	0,3	0,020	1,00	2,50	0,035	0,25	0,50
6,0	4°	0,3	0,024	1,20	3,00	0,044	0,30	0,60
6,0	4°	0,3	0,024	1,20	3,00	0,044	0,30	0,60
6,0	4°	0,3	0,024	1,20	3,00	0,044	0,30	0,60
8,0	3°	0,3	0,032	1,60	4,00	0,059	0,40	0,80
8,0	3°	0,3	0,032	1,60	4,00	0,059	0,40	0,80
8,0	3°	0,3	0,032	1,60	4,00	0,059	0,40	0,80
10,0	3°	0,3	0,041	2,00	5,00	0,077	0,50	1,00
10,0	3°	0,3	0,041	2,00	5,00	0,077	0,50	1,00
12,0	3°	0,3	0,048	2,40	6,00	0,091	0,60	1,20
12,0	3°	0,3	0,048	2,40	6,00	0,091	0,60	1,20
16,0	3°	0,3	0,065	3,20	8,00	0,126	0,80	1,60

Abmessungen in mm
Dimensions in mm

B

Schaftfräser 220° Vollradius

Ballnose End Mill 220°



DSKC 220°

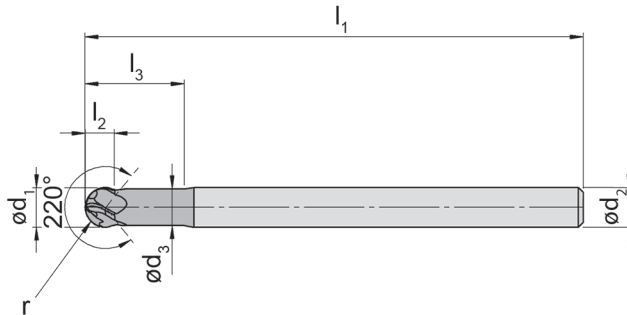
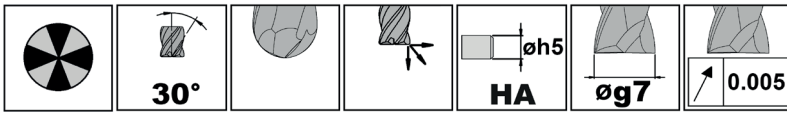

Bis Ø 3 mm vormontiert lieferbar für Toodle Schnelllaufspindel
Pre-assembled available up to Ø 3 mm for Toodle high-speed spindle

Bestellnummer Part number	d ₁	r	l ₂	l ₃	d ₃	d ₂	l ₁	Z	TSCC
DSKC.2.030.063.06.2	3	1,5	2,0	15	2,80	6	63	2	▲
DSKC.3.040.063.06.2	4	2,0	2,6	20	3,75	6	63	3	▲
DSKC.4.050.063.06.2	5	2,5	3,3	25	4,70	6	63	4	▲
DSKC.4.060.063.06.2	6	3,0	4,0	30	5,65	6	63	4	▲
DSKC.5.080.088.08.2	8	4,0	5,3	40	7,50	8	88	5	▲
DSKC.5.100.101.10.2	10	5,0	6,7	50	9,40	10	101	5	▲
DSKC.7.120.119.12.2	12	6,0	8,0	60	11,30	12	119	7	▲

▲ ab Lager / on stock Δ 4 Wochen / 4 weeks x auf Anfrage / upon request

● empfohlen / recommended

o bedingt einsetzbar / alternative recommendation

- nicht geeignet / not suitable

□ unbeschichtete HM-Sorten / uncoated grades

■ beschichtete HM-Sorten / coated grades

■ bestückt/Cermet / brazed/Cermet

Abmessungen in mm

Dimensions in mm



P	-
M	-
K	-
N	-
S	•
H	o



HM-Sorten
Carbide grades

Schnittdaten DSKC Ø 3,0 - 12,0 mm

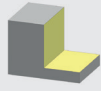
Cutting Data DSKC Ø 3,0 - 12,0 mm

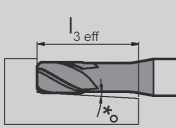

	 $vc = m/min$	 $vc = m/min$
S1	-	-
S2	45	60
S3	40	50

d_1	 α	 $l_{3\text{eff}}$ l_{*o} 0°						
			f_z	a_e	a_p	f_z	a_e	a_p
3	5°	0,3	0,015	0,60	1,50	0,026	0,15	0,30
4	5°	0,3	0,014	0,80	2,00	0,023	0,20	0,40
5	4°	0,3	0,015	1,00	2,50	0,027	0,25	0,50
6	4°	0,3	0,020	1,20	3,00	0,035	0,30	0,60
8	3°	0,3	0,027	1,60	4,00	0,050	0,40	0,80
10	3°	0,3	0,036	2,00	5,00	0,068	0,50	1,00
12	3°	0,3	0,043	2,40	6,00	0,082	0,60	1,20

Abmessungen in mm
Dimensions in mm

B

DSTC

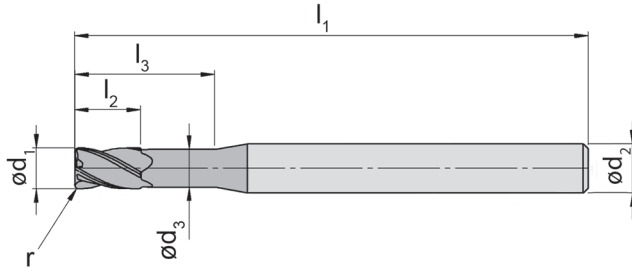
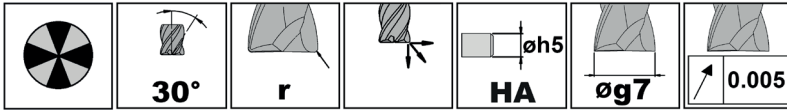

Bis Ø 3 mm vormontiert lieferbar für Toodle Schnelllaufspindel
Pre-assembled available up to Ø 3 mm for Toodle high-speed spindle

Bestellnummer Part number	d ₁	r	l ₂	l ₃	d ₃	d ₂	l ₁	Z	TSCC
DSTC.2.15.01.055.06	1,5	0,1	2,5	5,5	1,4	6	55	2	▲
DSTC.2.02.02.055.06	2,0	0,2	3,0	5,5	1,9	6	55	2	▲
DSTC.2.03.02.055.06	3,0	0,2	4,0	7,5	2,9	6	55	2	▲
DSTC.2.03.05.055.06	3,0	0,5	4,0	7,5	2,9	6	55	2	▲
DSTC.3.04.02.055.06	4,0	0,2	5,0	8,5	3,8	6	55	3	▲
DSTC.3.04.05.055.06	4,0	0,5	5,0	8,5	3,8	6	55	3	▲
DSTC.4.05.02.055.06	5,0	0,2	6,0	12,5	4,7	6	55	4	▲
DSTC.4.05.05.055.06	5,0	0,5	6,0	12,5	4,7	6	55	4	▲
DSTC.4.05.10.055.06	5,0	1,0	6,0	12,5	4,7	6	55	4	▲
DSTC.4.06.02.055.06	6,0	0,2	6,0	15,5	5,6	6	55	4	▲
DSTC.4.06.05.055.06	6,0	0,5	6,0	15,5	5,6	6	55	4	▲
DSTC.4.06.10.055.06	6,0	1,0	6,0	15,5	5,6	6	55	4	▲
DSTC.5.08.02.063.08	8,0	0,2	10,0	20,5	7,4	8	63	5	▲
DSTC.5.08.05.063.08	8,0	0,5	10,0	20,5	7,4	8	63	5	▲
DSTC.5.08.10.063.08	8,0	1,0	10,0	20,5	7,4	8	63	5	▲
DSTC.5.08.15.063.08	8,0	1,5	10,0	20,5	7,4	8	63	5	▲
DSTC.5.10.02.077.10	10,0	0,2	15,0	25,5	9,4	10	77	5	▲
DSTC.5.10.05.077.10	10,0	0,5	15,0	25,5	9,4	10	77	5	▲
DSTC.5.10.10.077.10	10,0	1,0	15,0	25,5	9,4	10	77	5	Δ
DSTC.5.10.15.077.10	10,0	1,5	15,0	25,5	9,4	10	77	5	Δ
DSTC.5.12.02.077.12	12,0	0,2	18,0	30,5	11,4	12	77	5	▲
DSTC.5.12.05.077.12	12,0	0,5	18,0	30,5	11,4	12	77	5	▲
DSTC.5.12.10.077.12	12,0	1,0	18,0	30,5	11,4	12	77	5	▲
DSTC.5.12.15.077.12	12,0	1,5	18,0	30,5	11,4	12	77	5	Δ
DSTC.5.12.20.077.12	12,0	2,0	18,0	30,5	11,4	12	77	5	▲

▲ ab Lager / on stock Δ 4 Wochen / 4 weeks x auf Anfrage / upon request

● empfohlen / recommended

o bedingt einsetzbar / alternative recommendation

- nicht geeignet / not suitable

■ unbeschichtete HM-Sorten / uncoated grades

■ beschichtete HM-Sorten / coated grades

■ bestückt/Cermet / brazed/Cermet

Abmessungen in mm

Dimensions in mm



P	-
M	-
K	-
N	-
S	•
H	o



HM-Sorten
Carbide grades

Schnittdaten DSTC Ø 1,5 - 12,0 mm

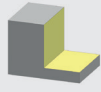
Cutting Data DSTC Ø 1,5 - 12,0 mm

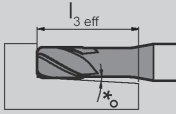

	 vc = m/min	 vc = m/min
S1	-	-
S2	45	60
S3	40	50

d ₁	 α	 l _{3 eff} / * _o						
			0°	f _z	a _e	a _p	f _z	a _e
1,5	5°	0,3	0,014	0,30	1,50	0,019	0,08	0,15
2,0	5°	0,3	0,017	0,40	2,00	0,025	0,10	0,20
3,0	5°	0,3	0,023	0,60	3,00	0,038	0,15	0,30
3,0	5°	0,3	0,023	0,60	3,00	0,038	0,15	0,30
4,0	5°	0,3	0,024	0,80	4,00	0,039	0,20	0,40
4,0	5°	0,3	0,024	0,80	4,00	0,039	0,20	0,40
5,0	4°	0,3	0,027	1,00	5,00	0,046	0,25	0,50
5,0	4°	0,3	0,027	1,00	5,00	0,046	0,25	0,50
5,0	4°	0,3	0,027	1,00	5,00	0,046	0,25	0,50
6,0	4°	0,3	0,034	1,20	6,00	0,058	0,30	0,60
6,0	4°	0,3	0,034	1,20	6,00	0,058	0,30	0,60
6,0	4°	0,3	0,034	1,20	6,00	0,058	0,30	0,60
8,0	3°	0,3	0,045	1,60	8,00	0,080	0,40	0,80
8,0	3°	0,3	0,045	1,60	8,00	0,080	0,40	0,80
8,0	3°	0,3	0,045	1,60	8,00	0,080	0,40	0,80
8,0	3°	0,3	0,045	1,60	8,00	0,080	0,40	0,80
10,0	3°	0,3	0,057	2,00	10,00	0,106	0,50	1,00
10,0	3°	0,3	0,057	2,00	10,00	0,106	0,50	1,00
10,0	3°	0,3	0,057	2,00	10,00	0,106	0,50	1,00
10,0	3°	0,3	0,057	2,00	10,00	0,106	0,50	1,00
12,0	3°	0,3	0,070	2,40	12,00	0,132	0,60	1,20
12,0	3°	0,3	0,070	2,40	12,00	0,132	0,60	1,20
12,0	3°	0,3	0,070	2,40	12,00	0,132	0,60	1,20
12,0	3°	0,3	0,070	2,40	12,00	0,132	0,60	1,20
12,0	3°	0,3	0,070	2,40	12,00	0,132	0,60	1,20

Abmessungen in mm
Dimensions in mm

B

Schaftfräser Mehrschneider

End Mill multiple fluted



DSMRC

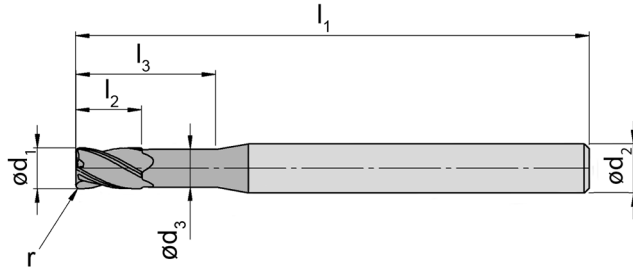
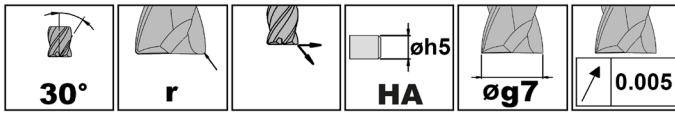

Bis Ø 3 mm vormontiert lieferbar für Toodle Schnelllaufspindel
Pre-assembled available up to Ø 3 mm for Toodle high-speed spindle

Bestellnummer Part number	d ₁	r	l ₂	l ₃	d ₃	d ₂	l ₁	Z	TSCC
DSMRC.4.03.55.06.02	3	0,2	9,5	9,5	-	6	55	4	▲
DSMRC.4.03.55.06.3S	3	0,3	3,0	9,5	2,9	6	55	4	▲
DSMRC.4.04.55.06.02	4	0,2	12,5	12,5	-	6	55	4	▲
DSMRC.4.04.55.06.3S	4	0,3	4,0	12,5	3,9	6	55	4	▲
DSMRC.4.05.55.06.02	5	0,2	15,5	15,5	-	6	55	4	▲
DSMRC.4.05.55.06.5S	5	0,5	5,0	15,5	4,8	6	55	4	▲
DSMRC.5.06.63.06.02	6	0,2	18,5	18,5	-	6	63	5	▲
DSMRC.5.06.63.06.5S	6	0,5	6,0	18,5	5,8	6	63	5	▲
DSMRC.5.08.63.08.10	8	1,0	24,5	24,5	-	8	63	5	▲
DSMRC.5.08.63.08.5S	8	0,5	8,0	24,5	7,8	8	63	5	▲
DSMRC.5.10.77.10.10	10	1,0	30,5	30,5	-	10	77	5	▲
DSMRC.5.10.77.10.5S	10	0,5	10,0	30,5	9,8	10	77	5	▲
DSMRC.7.12.88.12.10	12	1,0	36,5	36,5	-	12	88	7	▲
DSMRC.7.12.88.12.2S	12	0,2	12,0	36,5	11,8	12	88	7	▲
DSMRC.7.16.99.16.05	16	0,5	48,5	48,5	-	16	99	7	▲
DSMRC.7.16.99.16.20	16	2,0	48,5	48,5	-	16	99	7	▲

▲ ab Lager / on stock Δ 4 Wochen / 4 weeks x auf Anfrage / upon request

● empfohlen / recommended

o bedingt einsetzbar / alternative recommendation

- nicht geeignet / not suitable

unbeschichtete HM-Sorten / uncoated grades

beschichtete HM-Sorten / coated grades

bestückt/Cermet / brazed/Cermet

Abmessungen in mm

Dimensions in mm

P	-
M	-
K	-
N	-
S	•
H	◦



HM-Sorten
Carbide grades

Schnittdaten DSMRC Ø 3,0 - 16,0 mm

Cutting Data DSTC Ø 3,0 - 16,0 mm

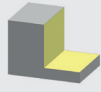
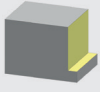

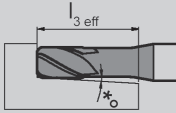
	 vc = m/min	 vc = m/min
S1	-	-
S2	45	60
S3	40	50

d ₁								
			f _z	a _e	a _p	f _z	a _e	a _p
3	3°	0,3	0,010	0,45	9,00	0,013	0,15	0,30
3	3°	0,3	0,010	0,45	3,00	0,013	0,15	0,30
4	3°	0,3	0,015	0,60	12,00	0,022	0,20	0,40
4	3°	0,3	0,015	0,60	4,00	0,022	0,20	0,40
5	3°	0,3	0,020	0,75	15,00	0,031	0,25	0,50
5	3°	0,3	0,020	0,75	5,00	0,031	0,25	0,50
6	3°	0,3	0,024	0,90	18,00	0,036	0,30	0,60
6	3°	0,3	0,024	0,90	6,00	0,036	0,30	0,60
8	3°	0,3	0,034	1,20	24,00	0,054	0,40	0,80
8	3°	0,3	0,034	1,20	8,00	0,054	0,40	0,80
10	3°	0,3	0,044	1,50	30,00	0,072	0,50	1,00
10	3°	0,3	0,044	1,50	10,00	0,072	0,50	1,00
12	3°	0,3	0,052	1,80	36,00	0,086	0,60	1,20
12	3°	0,3	0,052	1,80	12,00	0,086	0,60	1,20
16	3°	0,3	0,073	2,40	48,00	0,122	0,80	1,60
16	3°	0,3	0,073	2,40	48,00	0,122	0,80	1,60

Abmessungen in mm
Dimensions in mm

B

Vollhartmetall-Schaftfräser

Solid Carbide End Mills



DSRV.4

Schaftfräser Eckradius
End Mill, corner radius

Ø 2,0 – Ø 20,0

Z4

B126 – B139



DSRV.5

Schaftfräser Eckradius
End Mill, corner radius

Ø 2,0 – Ø 20,0

Z5

B140 – B151

B

DS



B

abgestimmt für:

- Titan

designed for:

- Titanium

DSRV

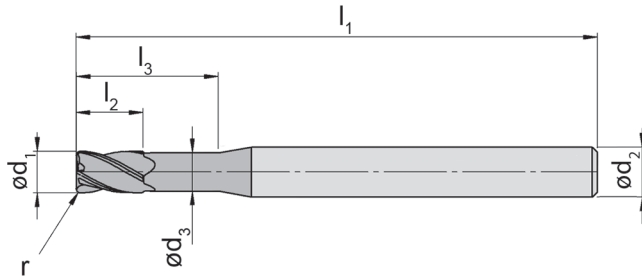
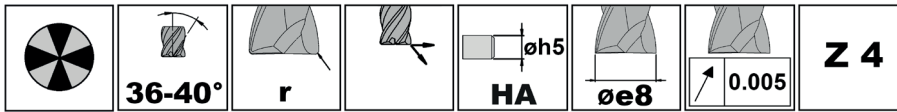

B

Bestellnummer Part number	d ₁	r	l ₂	l ₃	d ₃	d ₂	l ₁	Z	γ	Form Form	TSTK
DSRV.4.020.010.20	2	0,1	3	4	1,90	6	50	4	40°	HA	▲
DSRV.4.020.010.30	2	0,1	5	6	1,90	6	50	4	40°	HA	▲
DSRV.4.020.020.20	2	0,2	3	4	1,90	6	50	4	40°	HA	▲
DSRV.4.020.020.30	2	0,2	5	6	1,90	6	50	4	40°	HA	▲
DSRV.4.030.010.20	3	0,1	5	6	2,85	6	50	4	40°	HA	▲
DSRV.4.030.010.30	3	0,1	7	9	2,85	6	50	4	40°	HA	▲
DSRV.4.030.020.20	3	0,2	5	6	2,85	6	50	4	40°	HA	▲
DSRV.4.030.020.30	3	0,2	7	9	2,85	6	50	4	40°	HA	▲
DSRV.4.030.050.20	3	0,5	5	6	2,85	6	50	4	40°	HA	▲
DSRV.4.030.050.30	3	0,5	7	9	2,85	6	50	4	40°	HA	▲
DSRV.4.040.010.20	4	0,1	6	8	3,80	6	50	4	40°	HA	▲
DSRV.4.040.010.30	4	0,1	9	12	3,80	6	57	4	40°	HA	▲
DSRV.4.040.020.20	4	0,2	6	8	3,80	6	50	4	40°	HA	▲
DSRV.4.040.020.30	4	0,2	9	12	3,80	6	57	4	40°	HA	▲
DSRV.4.040.050.20	4	0,5	6	8	3,80	6	50	4	40°	HA	▲
DSRV.4.040.050.30	4	0,5	9	12	3,80	6	57	4	40°	HA	▲
DSRV.4.050.010.20	5	0,1	8	10	4,75	6	50	4	40°	HA	▲
DSRV.4.050.010.30	5	0,1	11	15	4,75	6	57	4	40°	HA	▲
DSRV.4.050.020.20	5	0,2	8	10	4,75	6	50	4	40°	HA	▲
DSRV.4.050.020.30	5	0,2	11	15	4,75	6	57	4	40°	HA	▲
DSRV.4.050.050.20	5	0,5	8	10	4,75	6	50	4	40°	HA	▲
DSRV.4.050.050.30	5	0,5	11	15	4,75	6	57	4	40°	HA	▲
DSRV.4.050.100.20	5	1,0	8	10	4,75	6	50	4	40°	HA	▲
DSRV.4.050.100.30	5	1,0	11	15	4,75	6	57	4	40°	HA	▲

▲ ab Lager / on stock Δ 4 Wochen / 4 weeks x auf Anfrage / upon request

● empfohlen / recommended

o bedingt einsetzbar / alternative recommendation

- nicht geeignet / not suitable

■ unbeschichtete HM-Sorten / uncoated grades

■ beschichtete HM-Sorten / coated grades

■ bestückt/Cermet / brazed/Cermet

Abmessungen in mm

Dimensions in mm

P	•
M	•
K	o
N	-
S	•
H	-



HM-Sorten
Carbide grades

Schnittdaten DSRV Ø 2,0 - 5,0 mm

Cutting Data DSRV Ø 2,0 - 5,0 mm

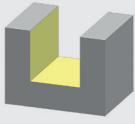
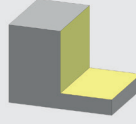
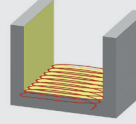

	 vc = m/min	 vc = m/min	 vc = m/min
M1.1	100	130	190
M2.1	80	100	150
M3.1	70	90	130
S1.1	60	80	120
S2.1	40	50	70
S3.1	33	40	60

d ₁										
		f _z	a _e	a _p	f _z	a _e	a _p	f _z	a _e	a _p
2	5°	0,008	2,00	2,00	0,009	0,40	3,00	0,038	0,10	3,00
2	5°	0,007	2,00	2,00	0,008	0,40	4,00	0,040	0,10	4,00
2	5°	0,008	2,00	2,00	0,009	0,40	3,00	0,045	0,10	3,00
2	5°	0,007	2,00	2,00	0,008	0,40	4,00	0,040	0,10	4,00
3	5°	0,012	3,00	3,00	0,016	0,60	4,50	0,066	0,15	4,50
3	5°	0,010	3,00	3,00	0,014	0,60	6,00	0,059	0,15	6,00
3	5°	0,012	3,00	3,00	0,016	0,60	4,50	0,066	0,15	4,50
3	5°	0,010	3,00	3,00	0,014	0,60	6,00	0,059	0,15	6,00
3	5°	0,012	3,00	3,00	0,016	0,60	4,50	0,066	0,15	4,50
3	5°	0,010	3,00	3,00	0,014	0,60	6,00	0,059	0,15	6,00
4	5°	0,016	4,00	4,00	0,022	0,80	6,00	0,087	0,20	6,00
4	5°	0,013	4,00	4,00	0,020	0,80	8,00	0,079	0,20	8,00
4	5°	0,016	4,00	4,00	0,022	0,80	6,00	0,087	0,20	6,00
4	5°	0,013	4,00	4,00	0,020	0,80	8,00	0,079	0,20	8,00
4	5°	0,016	4,00	4,00	0,022	0,80	6,00	0,087	0,20	6,00
4	5°	0,013	4,00	4,00	0,020	0,80	8,00	0,079	0,20	8,00
5	5°	0,020	5,00	5,00	0,029	1,00	7,50	0,109	0,25	7,50
5	5°	0,016	5,00	5,00	0,026	1,00	10,00	0,098	0,25	10,00
5	5°	0,020	5,00	5,00	0,029	1,00	7,50	0,109	0,25	7,50
5	5°	0,016	5,00	5,00	0,026	1,00	10,00	0,098	0,25	10,00
5	5°	0,020	5,00	5,00	0,029	1,00	7,50	0,109	0,25	7,50
5	5°	0,016	5,00	5,00	0,026	1,00	10,00	0,098	0,25	10,00
5	5°	0,020	5,00	5,00	0,029	1,00	7,50	0,109	0,25	7,50
5	5°	0,016	5,00	5,00	0,026	1,00	10,00	0,098	0,25	10,00

Abmessungen in mm
Dimensions in mm

B

DSRV

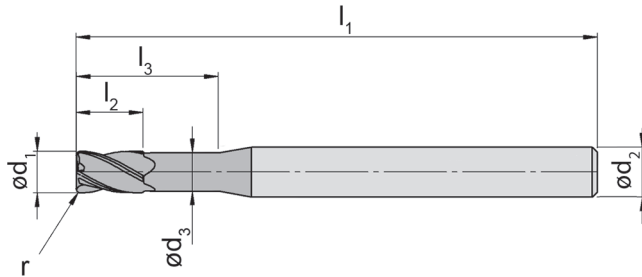
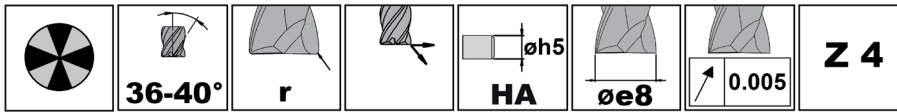

B

Bestellnummer Part number	d ₁	r	l ₂	l ₃	d ₃	d ₂	l ₁	Z	Form Form	TSTK
DSRV.4.060.010.20	6	0,1	9	12	5,7	6	50	4	HA	▲
DSRV.4.060.010.30	6	0,1	13	18	5,7	6	57	4	HA	▲
DSRV.4.060.020.20	6	0,2	9	12	5,7	6	50	4	HA	▲
DSRV.4.060.020.30	6	0,2	13	18	5,7	6	57	4	HA	▲
DSRV.4.060.050.20	6	0,5	9	12	5,7	6	50	4	HA	▲
DSRV.4.060.050.30	6	0,5	13	18	5,7	6	57	4	HA	▲
DSRV.4.060.100.30	6	1,0	13	18	5,7	6	57	4	HA	▲
DSRV.4.060.100.20	6	1,0	9	12	5,7	6	50	4	HA	▲
DSRV.4.080.010.20	8	0,1	12	16	7,6	8	58	4	HA	▲
DSRV.4.080.010.30	8	0,1	17	24	7,6	8	63	4	HA	▲
DSRV.4.080.020.20	8	0,2	12	16	7,6	8	58	4	HA	▲
DSRV.4.080.020.30	8	0,2	17	24	7,6	8	63	4	HA	▲
DSRV.4.080.050.20	8	0,5	12	16	7,6	8	58	4	HA	▲
DSRV.4.080.050.30	8	0,5	17	24	7,6	8	63	4	HA	▲
DSRV.4.080.100.20	8	1,0	12	16	7,6	8	58	4	HA	▲
DSRV.4.080.100.30	8	1,0	17	24	7,6	8	63	4	HA	▲
DSRV.4.080.150.20	8	1,5	12	16	7,6	8	58	4	HA	▲
DSRV.4.080.150.30	8	1,5	17	24	7,6	8	63	4	HA	▲

▲ ab Lager / on stock Δ 4 Wochen / 4 weeks x auf Anfrage / upon request

● empfohlen / recommended

o bedingt einsetzbar / alternative recommendation

- nicht geeignet / not suitable

■ unbeschichtete HM-Sorten / uncoated grades

■ beschichtete HM-Sorten / coated grades

■ bestückt/Cermet / brazed/Cermet

Abmessungen in mm

Dimensions in mm

P	•
M	•
K	o
N	-
S	•
H	-



HM-Sorten
Carbide grades

Schnittdaten DSRV Ø 6,0 - 8,0 mm

Cutting Data DSRV Ø 6,0 - 8,0 mm

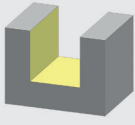
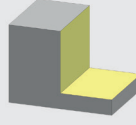
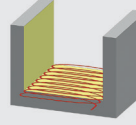

	 vc = m/min	 vc = m/min	 vc = m/min
M1.1	100	130	190
M2.1	80	100	150
M3.1	70	90	130
S1.1	60	80	120
S2.1	40	50	70
S3.1	33	40	60

d ₁										
		f _z	a _e	a _p	f _z	a _e	a _p	f _z	a _e	a _p
6	5°	0,024	6,00	6,00	0,035	1,20	9,00	0,130	0,30	9,00
6	5°	0,020	6,00	6,00	0,031	1,20	12,00	0,117	0,30	12,00
6	5°	0,024	6,00	6,00	0,035	1,20	9,00	0,130	0,30	9,00
6	5°	0,020	6,00	6,00	0,031	1,20	12,00	0,117	0,30	12,00
6	5°	0,024	6,00	6,00	0,035	1,20	9,00	0,130	0,30	9,00
6	5°	0,020	6,00	6,00	0,031	1,20	12,00	0,117	0,30	12,00
6	5°	0,024	6,00	6,00	0,035	1,20	9,00	0,130	0,30	9,00
6	5°	0,020	6,00	6,00	0,031	1,20	12,00	0,117	0,30	12,00
8	5°	0,032	8,00	8,00	0,048	1,60	12,00	0,172	0,40	12,00
8	5°	0,026	8,00	8,00	0,043	1,60	16,00	0,155	0,40	16,00
8	5°	0,032	8,00	8,00	0,048	1,60	12,00	0,172	0,40	12,00
8	5°	0,026	8,00	8,00	0,043	1,60	16,00	0,155	0,40	16,00
8	5°	0,032	8,00	8,00	0,048	1,60	12,00	0,172	0,40	12,00
8	5°	0,026	8,00	8,00	0,043	1,60	16,00	0,155	0,40	16,00
8	5°	0,032	8,00	8,00	0,048	1,60	12,00	0,172	0,40	12,00
8	5°	0,026	8,00	8,00	0,043	1,60	16,00	0,155	0,40	16,00
8	5°	0,032	8,00	8,00	0,048	1,60	12,00	0,172	0,40	12,00
8	5°	0,026	8,00	8,00	0,043	1,60	16,00	0,155	0,40	16,00

Abmessungen in mm
Dimensions in mm

B

Schaftfräser

End Mill



DSRV

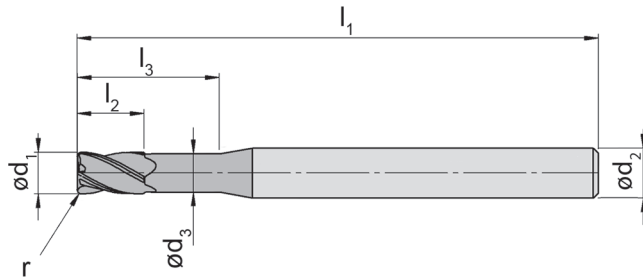
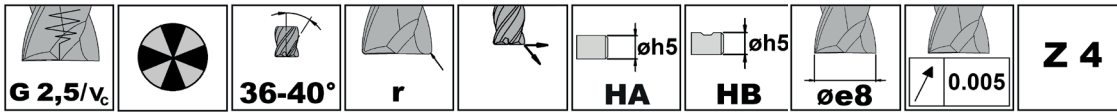

B

Bestellnummer Part number	d ₁	r	l ₂	l ₃	d ₃	d ₂	l ₁	Z	Form Form	TSTK
DSRV.4.100.010.20	10	0,1	15	20	9,5	10	66	4	HA	▲
DSRV.4.100.010.20B	10	0,1	15	20	9,5	10	66	4	HB	▲
DSRV.4.100.010.30	10	0,1	21	30	9,5	10	72	4	HA	▲
DSRV.4.100.010.30B	10	0,1	21	30	9,5	10	72	4	HB	▲
DSRV.4.100.020.20	10	0,2	15	20	9,5	10	66	4	HA	▲
DSRV.4.100.020.20B	10	0,2	15	20	9,5	10	66	4	HB	▲
DSRV.4.100.020.30	10	0,2	21	30	9,5	10	72	4	HA	▲
DSRV.4.100.020.30B	10	0,2	21	30	9,5	10	72	4	HB	▲
DSRV.4.100.050.20	10	0,5	15	20	9,5	10	66	4	HA	▲
DSRV.4.100.050.20B	10	0,5	15	20	9,5	10	66	4	HB	▲
DSRV.4.100.050.30	10	0,5	21	30	9,5	10	72	4	HA	▲
DSRV.4.100.050.30B	10	0,5	21	30	9,5	10	72	4	HB	▲
DSRV.4.100.100.20	10	1,0	15	20	9,5	10	66	4	HA	▲
DSRV.4.100.100.20B	10	1,0	15	20	9,5	10	66	4	HB	▲
DSRV.4.100.100.30	10	1,0	21	30	9,5	10	72	4	HA	▲
DSRV.4.100.100.30B	10	1,0	21	30	9,5	10	72	4	HB	▲
DSRV.4.100.150.20	10	1,5	15	20	9,5	10	66	4	HA	▲
DSRV.4.100.150.20B	10	1,5	15	20	9,5	10	66	4	HB	▲
DSRV.4.100.150.30	10	1,5	21	30	9,5	10	72	4	HA	▲
DSRV.4.100.150.30B	10	1,5	21	30	9,5	10	72	4	HB	▲
DSRV.4.100.200.20	10	2,0	15	20	9,5	10	66	4	HA	▲
DSRV.4.100.200.20B	10	2,0	15	20	9,5	10	66	4	HB	▲
DSRV.4.100.200.30	10	2,0	21	30	9,5	10	72	4	HA	▲
DSRV.4.100.200.30B	10	2,0	21	30	9,5	10	72	4	HB	▲
DSRV.4.100.250.20	10	2,5	15	20	9,5	10	66	4	HA	▲
DSRV.4.100.250.20B	10	2,5	15	20	9,5	10	66	4	HB	▲
DSRV.4.100.250.30	10	2,5	21	30	9,5	10	72	4	HA	▲
DSRV.4.100.250.30B	10	2,5	21	30	9,5	10	72	4	HB	▲
DSRV.4.100.300.20	10	3,0	15	20	9,5	10	66	4	HA	▲
DSRV.4.100.300.20B	10	3,0	15	20	9,5	10	66	4	HB	▲
DSRV.4.100.300.30	10	3,0	21	30	9,5	10	72	4	HA	▲
DSRV.4.100.300.30B	10	3,0	21	30	9,5	10	72	4	HB	▲

▲ ab Lager / on stock Δ 4 Wochen / 4 weeks x auf Anfrage / upon request

● empfohlen / recommended

o bedingt einsetzbar / alternative recommendation

- nicht geeignet / not suitable

■ unbeschichtete HM-Sorten / uncoated grades

■ beschichtete HM-Sorten / coated grades

■ bestückt/Cermet / brazed/Cermet

Abmessungen in mm

Dimensions in mm



P	•
M	•
K	o
N	-
S	•
H	-

Schnittdaten DSRV Ø 10 mm

Cutting Data DSRV Ø 10 mm

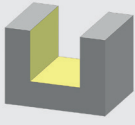
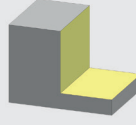
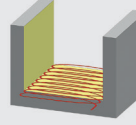

	 vc = m/min	 vc = m/min	 vc = m/min
M1.1	100	130	190
M2.1	80	100	150
M3.1	70	90	130
S1.1	60	80	120
S2.1	40	50	70
S3.1	33	40	60

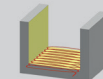
d ₁										
		f _z	a _e	a _p	f _z	a _e	a _p	f _z	a _e	a _p
10	5°	0,040	10,00	10,00	0,060	2,00	15,00	0,215	0,50	15,00
10	5°	0,040	10,00	10,00	0,060	2,00	15,00	0,215	0,50	15,00
10	5°	0,032	10,00	10,00	0,054	2,00	20,00	0,194	0,50	20,00
10	5°	0,032	10,00	10,00	0,054	2,00	20,00	0,194	0,50	20,00
10	5°	0,040	10,00	10,00	0,060	2,00	15,00	0,215	0,50	15,00
10	5°	0,040	10,00	10,00	0,060	2,00	15,00	0,215	0,50	15,00
10	5°	0,032	10,00	10,00	0,054	2,00	20,00	0,194	0,50	20,00
10	5°	0,032	10,00	10,00	0,054	2,00	20,00	0,194	0,50	20,00
10	5°	0,040	10,00	10,00	0,060	2,00	15,00	0,215	0,50	15,00
10	5°	0,040	10,00	10,00	0,060	2,00	15,00	0,215	0,50	15,00
10	5°	0,032	10,00	10,00	0,054	2,00	20,00	0,194	0,50	20,00
10	5°	0,032	10,00	10,00	0,054	2,00	20,00	0,194	0,50	20,00
10	5°	0,040	10,00	10,00	0,060	2,00	15,00	0,215	0,50	15,00
10	5°	0,040	10,00	10,00	0,060	2,00	15,00	0,215	0,50	15,00
10	5°	0,032	10,00	10,00	0,054	2,00	20,00	0,194	0,50	20,00
10	5°	0,032	10,00	10,00	0,054	2,00	20,00	0,194	0,50	20,00
10	5°	0,040	10,00	10,00	0,060	2,00	15,00	0,215	0,50	15,00
10	5°	0,040	10,00	10,00	0,060	2,00	15,00	0,215	0,50	15,00
10	5°	0,032	10,00	10,00	0,054	2,00	20,00	0,194	0,50	20,00
10	5°	0,032	10,00	10,00	0,054	2,00	20,00	0,194	0,50	20,00
10	5°	0,040	10,00	10,00	0,060	2,00	15,00	0,215	0,50	15,00
10	5°	0,040	10,00	10,00	0,060	2,00	15,00	0,215	0,50	15,00
10	5°	0,032	10,00	10,00	0,054	2,00	20,00	0,194	0,50	20,00
10	5°	0,032	10,00	10,00	0,054	2,00	20,00	0,194	0,50	20,00
10	5°	0,040	10,00	10,00	0,060	2,00	15,00	0,215	0,50	15,00
10	5°	0,040	10,00	10,00	0,060	2,00	15,00	0,215	0,50	15,00
10	5°	0,032	10,00	10,00	0,054	2,00	20,00	0,194	0,50	20,00
10	5°	0,032	10,00	10,00	0,054	2,00	20,00	0,194	0,50	20,00
10	5°	0,040	10,00	10,00	0,060	2,00	15,00	0,215	0,50	15,00
10	5°	0,040	10,00	10,00	0,060	2,00	15,00	0,215	0,50	15,00
10	5°	0,032	10,00	10,00	0,054	2,00	20,00	0,194	0,50	20,00
10	5°	0,032	10,00	10,00	0,054	2,00	20,00	0,194	0,50	20,00

Abmessungen in mm
Dimensions in mm

B

DSRV

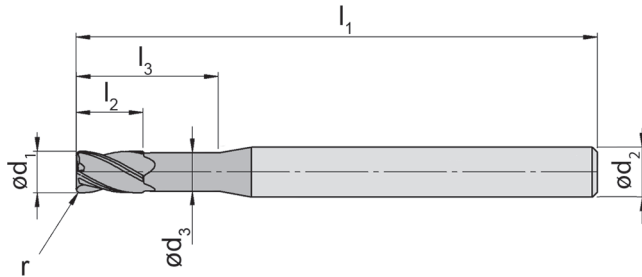
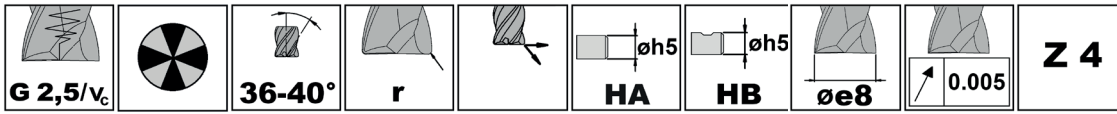

B

Bestellnummer Part number	d ₁	r	l ₂	l ₃	d ₃	d ₂	l ₁	Z	Form Form	TSTK
DSRV.4.120.020.20	12	0,2	18	24	11,4	12	73	4	HA	▲
DSRV.4.120.020.20B	12	0,2	18	24	11,4	12	73	4	HB	▲
DSRV.4.120.020.30	12	0,2	26	36	11,4	12	83	4	HA	▲
DSRV.4.120.020.30B	12	0,2	26	36	11,4	12	83	4	HB	▲
DSRV.4.120.050.20	12	0,5	18	24	11,4	12	73	4	HA	▲
DSRV.4.120.050.20B	12	0,5	18	24	11,4	12	73	4	HB	▲
DSRV.4.120.050.30	12	0,5	26	36	11,4	12	83	4	HA	▲
DSRV.4.120.050.30B	12	0,5	26	36	11,4	12	83	4	HB	▲
DSRV.4.120.100.20	12	1,0	18	24	11,4	12	73	4	HA	▲
DSRV.4.120.100.20B	12	1,0	18	24	11,4	12	73	4	HB	▲
DSRV.4.120.100.30	12	1,0	26	36	11,4	12	83	4	HA	▲
DSRV.4.120.100.30B	12	1,0	26	36	11,4	12	83	4	HB	▲
DSRV.4.120.150.20	12	1,5	18	24	11,4	12	73	4	HA	▲
DSRV.4.120.150.20B	12	1,5	18	24	11,4	12	73	4	HB	▲
DSRV.4.120.150.30	12	1,5	26	36	11,4	12	83	4	HA	▲
DSRV.4.120.150.30B	12	1,5	26	36	11,4	12	83	4	HB	▲
DSRV.4.120.200.20	12	2,0	18	24	11,4	12	73	4	HA	▲
DSRV.4.120.200.20B	12	2,0	18	24	11,4	12	73	4	HB	▲
DSRV.4.120.200.30	12	2,0	26	36	11,4	12	83	4	HA	▲
DSRV.4.120.200.30B	12	2,0	26	36	11,4	12	83	4	HB	▲
DSRV.4.120.250.20	12	2,5	18	24	11,4	12	73	4	HA	▲
DSRV.4.120.250.20B	12	2,5	18	24	11,4	12	73	4	HB	▲
DSRV.4.120.250.30	12	2,5	26	36	11,4	12	83	4	HA	▲
DSRV.4.120.250.30B	12	2,5	26	36	11,4	12	83	4	HB	▲
DSRV.4.120.300.30	12	3,0	26	36	11,4	12	83	4	HA	▲
DSRV.4.120.300.30B	12	3,0	26	36	11,4	12	83	4	HB	▲
DSRV.4.120.300.20	12	3,0	18	24	11,4	12	73	4	HA	▲
DSRV.4.120.300.20B	12	3,0	18	24	11,4	12	73	4	HB	▲

▲ ab Lager / on stock Δ 4 Wochen / 4 weeks x auf Anfrage / upon request

● empfohlen / recommended

o bedingt einsetzbar / alternative recommendation

- nicht geeignet / not suitable

■ unbeschichtete HM-Sorten / uncoated grades

■ beschichtete HM-Sorten / coated grades

■ bestückt/Cermet / brazed/Cermet

Abmessungen in mm

Dimensions in mm

P	•
M	•
K	○
N	-
S	•
H	-



HM-Sorten
Carbide grades

Schnittdaten DSRV Ø 12 mm

Cutting Data DSRV Ø 12 mm

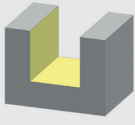
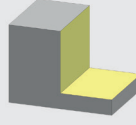
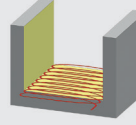

	 vc = m/min	 vc = m/min	 vc = m/min
M1.1	100	130	190
M2.1	80	100	150
M3.1	70	90	130
S1.1	60	80	120
S2.1	40	50	70
S3.1	33	40	60

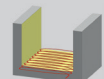
d ₁										
		f _z	a _e	a _p	f _z	a _e	a _p	f _z	a _e	a _p
12	5°	0,048	12,00	12,00	0,073	2,40	18,00	0,258	0,60	18,00
12	5°	0,048	12,00	12,00	0,073	2,40	18,00	0,258	0,60	18,00
12	5°	0,039	12,00	12,00	0,066	2,40	24,00	0,232	0,60	24,00
12	5°	0,039	12,00	12,00	0,066	2,40	24,00	0,232	0,60	24,00
12	5°	0,048	12,00	12,00	0,073	2,40	18,00	0,258	0,60	18,00
12	5°	0,048	12,00	12,00	0,073	2,40	18,00	0,258	0,60	18,00
12	5°	0,039	12,00	12,00	0,066	2,40	24,00	0,232	0,60	24,00
12	5°	0,039	12,00	12,00	0,066	2,40	24,00	0,232	0,60	24,00
12	5°	0,048	12,00	12,00	0,073	2,40	18,00	0,258	0,60	18,00
12	5°	0,048	12,00	12,00	0,073	2,40	18,00	0,258	0,60	18,00
12	5°	0,039	12,00	12,00	0,066	2,40	24,00	0,232	0,60	24,00
12	5°	0,039	12,00	12,00	0,066	2,40	24,00	0,232	0,60	24,00
12	5°	0,048	12,00	12,00	0,073	2,40	18,00	0,258	0,60	18,00
12	5°	0,048	12,00	12,00	0,073	2,40	18,00	0,258	0,60	18,00
12	5°	0,039	12,00	12,00	0,066	2,40	24,00	0,232	0,60	24,00
12	5°	0,039	12,00	12,00	0,066	2,40	24,00	0,232	0,60	24,00
12	5°	0,048	12,00	12,00	0,073	2,40	18,00	0,258	0,60	18,00
12	5°	0,048	12,00	12,00	0,073	2,40	18,00	0,258	0,60	18,00
12	5°	0,039	12,00	12,00	0,066	2,40	24,00	0,232	0,60	24,00
12	5°	0,039	12,00	12,00	0,066	2,40	24,00	0,232	0,60	24,00
12	5°	0,048	12,00	12,00	0,073	2,40	18,00	0,258	0,60	18,00
12	5°	0,048	12,00	12,00	0,073	2,40	18,00	0,258	0,60	18,00
12	5°	0,039	12,00	12,00	0,066	2,40	24,00	0,232	0,60	24,00
12	5°	0,039	12,00	12,00	0,066	2,40	24,00	0,232	0,60	24,00
12	5°	0,048	12,00	12,00	0,073	2,40	18,00	0,258	0,60	18,00
12	5°	0,048	12,00	12,00	0,073	2,40	18,00	0,258	0,60	18,00
12	5°	0,039	12,00	12,00	0,066	2,40	24,00	0,232	0,60	24,00
12	5°	0,039	12,00	12,00	0,066	2,40	24,00	0,232	0,60	24,00

Abmessungen in mm
Dimensions in mm

B

Schaftfräser

End Mill



DSRV

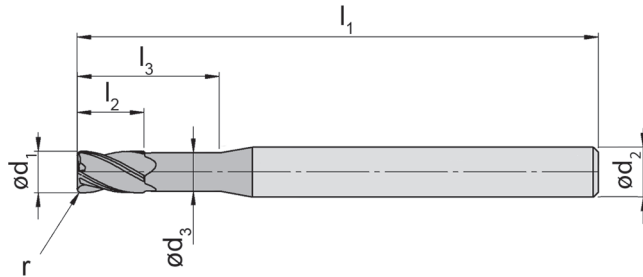
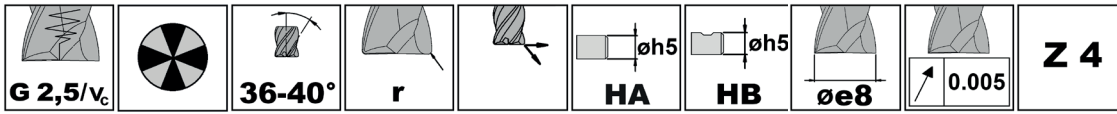

B

Bestellnummer Part number	d ₁	r	l ₂	l ₃	d ₃	d ₂	l ₁	Z	Form Form	TSTK
DSRV.4.160.020.20	16	0,2	24	32	15,2	16	82	4	HA	▲
DSRV.4.160.020.20B	16	0,2	24	32	15,2	16	82	4	HB	▲
DSRV.4.160.020.30	16	0,2	34	48	15,2	16	100	4	HA	▲
DSRV.4.160.020.30B	16	0,2	34	48	15,2	16	100	4	HB	▲
DSRV.4.160.050.20	16	0,5	24	32	15,2	16	82	4	HA	▲
DSRV.4.160.050.20B	16	0,5	24	32	15,2	16	82	4	HB	▲
DSRV.4.160.050.30	16	0,5	34	48	15,2	16	100	4	HA	▲
DSRV.4.160.050.30B	16	0,5	34	48	15,2	16	100	4	HB	▲
DSRV.4.160.100.20	16	1,0	24	32	15,2	16	82	4	HA	▲
DSRV.4.160.100.20B	16	1,0	24	32	15,2	16	82	4	HB	▲
DSRV.4.160.100.30	16	1,0	34	48	15,2	16	100	4	HA	▲
DSRV.4.160.100.30B	16	1,0	34	48	15,2	16	100	4	HB	▲
DSRV.4.160.150.20	16	1,5	24	32	15,2	16	82	4	HA	▲
DSRV.4.160.150.30	16	1,5	34	48	15,2	16	100	4	HA	▲
DSRV.4.160.150.20B	16	1,5	24	32	15,2	16	82	4	HB	▲
DSRV.4.160.150.30B	16	1,5	34	48	15,2	16	100	4	HB	▲
DSRV.4.160.200.20	16	2,0	24	32	15,2	16	82	4	HA	▲
DSRV.4.160.200.20B	16	2,0	24	32	15,2	16	82	4	HB	▲
DSRV.4.160.200.30	16	2,0	34	48	15,2	16	100	4	HA	▲
DSRV.4.160.200.30B	16	2,0	34	48	15,2	16	100	4	HB	▲
DSRV.4.160.250.20	16	2,5	24	32	15,2	16	82	4	HA	▲
DSRV.4.160.250.20B	16	2,5	24	32	15,2	16	82	4	HB	▲
DSRV.4.160.250.30	16	2,5	34	48	15,2	16	100	4	HA	▲
DSRV.4.160.250.30B	16	2,5	34	48	15,2	16	100	4	HB	▲
DSRV.4.160.300.20	16	3,0	24	32	15,2	16	82	4	HA	▲
DSRV.4.160.300.20B	16	3,0	24	32	15,2	16	82	4	HB	▲
DSRV.4.160.300.30	16	3,0	34	48	15,2	16	100	4	HA	▲
DSRV.4.160.300.30B	16	3,0	34	48	15,2	16	100	4	HB	▲
DSRV.4.160.400.20	16	4,0	24	32	15,2	16	82	4	HA	▲
DSRV.4.160.400.20B	16	4,0	24	32	15,2	16	82	4	HB	▲
DSRV.4.160.400.30	16	4,0	34	48	15,2	16	100	4	HA	▲
DSRV.4.160.400.30B	16	4,0	34	48	15,2	16	100	4	HB	▲

▲ ab Lager / on stock Δ 4 Wochen / 4 weeks x auf Anfrage / upon request

● empfohlen / recommended

o bedingt einsetzbar / alternative recommendation

- nicht geeignet / not suitable

■ unbeschichtete HM-Sorten / uncoated grades

■ beschichtete HM-Sorten / coated grades

■ bestückt/Cermet / brazed/Cermet

Abmessungen in mm

Dimensions in mm

P	•
M	•
K	•
N	-
S	•
H	-

DSRV

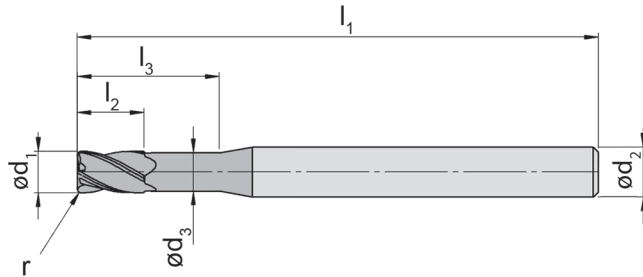
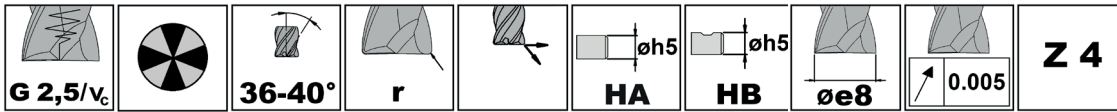

B

Bestellnummer Part number	d ₁	r	l ₂	l ₃	d ₃	d ₂	l ₁	Z	Form Form	TSTK
DSRV.4.200.020.20	20	0,2	30	40	19	20	92	4	HA	▲
DSRV.4.200.020.20B	20	0,2	30	40	19	20	92	4	HB	▲
DSRV.4.200.020.30	20	0,2	42	60	19	20	120	4	HA	▲
DSRV.4.200.020.30B	20	0,2	42	60	19	20	120	4	HB	▲
DSRV.4.200.050.20	20	0,5	30	40	19	20	92	4	HA	▲
DSRV.4.200.050.20B	20	0,5	30	40	19	20	92	4	HB	▲
DSRV.4.200.050.30	20	0,5	42	60	19	20	120	4	HA	▲
DSRV.4.200.050.30B	20	0,5	42	60	19	20	120	4	HB	▲
DSRV.4.200.100.20	20	1,0	30	40	19	20	92	4	HA	▲
DSRV.4.200.100.20B	20	1,0	30	40	19	20	92	4	HB	▲
DSRV.4.200.100.30	20	1,0	42	60	19	20	120	4	HA	▲
DSRV.4.200.100.30B	20	1,0	42	60	19	20	120	4	HB	▲
DSRV.4.200.150.20	20	1,5	30	40	19	20	92	4	HA	▲
DSRV.4.200.150.20B	20	1,5	30	40	19	20	92	4	HB	▲
DSRV.4.200.150.30	20	1,5	42	60	19	20	120	4	HA	▲
DSRV.4.200.150.30B	20	1,5	42	60	19	20	120	4	HB	▲
DSRV.4.200.200.20	20	2,0	30	40	19	20	92	4	HA	▲
DSRV.4.200.200.20B	20	2,0	30	40	19	20	92	4	HB	▲
DSRV.4.200.200.30	20	2,0	42	60	19	20	120	4	HA	▲
DSRV.4.200.200.30B	20	2,0	42	60	19	20	120	4	HB	▲
DSRV.4.200.250.20	20	2,5	30	40	19	20	92	4	HA	▲
DSRV.4.200.250.20B	20	2,5	30	40	19	20	92	4	HB	▲
DSRV.4.200.250.30	20	2,5	42	60	19	20	120	4	HA	▲
DSRV.4.200.250.30B	20	2,5	42	60	19	20	120	4	HB	▲
DSRV.4.200.300.20	20	3,0	30	40	19	20	92	4	HA	▲
DSRV.4.200.300.20B	20	3,0	30	40	19	20	92	4	HB	▲
DSRV.4.200.300.30	20	3,0	42	60	19	20	120	4	HA	▲
DSRV.4.200.300.30B	20	3,0	42	60	19	20	120	4	HB	▲
DSRV.4.200.400.20	20	4,0	30	40	19	20	92	4	HA	▲
DSRV.4.200.400.20B	20	4,0	30	40	19	20	92	4	HB	▲
DSRV.4.200.400.30	20	4,0	42	60	19	20	120	4	HA	▲
DSRV.4.200.400.30B	20	4,0	42	60	19	20	120	4	HB	▲

▲ ab Lager / on stock Δ 4 Wochen / 4 weeks x auf Anfrage / upon request

● empfohlen / recommended

o bedingt einsetzbar / alternative recommendation

- nicht geeignet / not suitable

■ unbeschichtete HM-Sorten / uncoated grades

■ beschichtete HM-Sorten / coated grades

■ bestückt/Cermet / brazed/Cermet

Abmessungen in mm

Dimensions in mm



P	•
M	•
K	o
N	-
S	•
H	-

Schnittdaten DSRV Ø 20 mm

Cutting Data DSRV Ø 20 mm

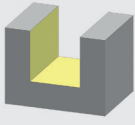
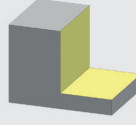
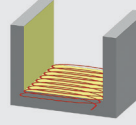

	 vc = m/min	 vc = m/min	 vc = m/min
M1.1	100	130	190
M2.1	80	100	150
M3.1	70	90	130
S1.1	60	80	120
S2.1	40	50	70
S3.1	33	40	60

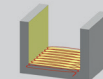
d ₁	 α									
		f _z	a _e	a _p	f _z	a _e	a _p	f _z	a _e	a _p
20	5°	0,080	20,00	20,00	0,124	4,00	30,00	0,428	1,00	30,00
20	5°	0,080	20,00	20,00	0,124	4,00	30,00	0,428	1,00	30,00
20	5°	0,064	20,00	20,00	0,112	4,00	40,00	0,385	1,00	40,00
20	5°	0,064	20,00	20,00	0,112	4,00	40,00	0,385	1,00	40,00
20	5°	0,080	20,00	20,00	0,124	4,00	30,00	0,428	1,00	30,00
20	5°	0,080	20,00	20,00	0,124	4,00	30,00	0,428	1,00	30,00
20	5°	0,064	20,00	20,00	0,112	4,00	40,00	0,385	1,00	40,00
20	5°	0,064	20,00	20,00	0,112	4,00	40,00	0,385	1,00	40,00
20	5°	0,080	20,00	20,00	0,124	4,00	30,00	0,428	1,00	30,00
20	5°	0,080	20,00	20,00	0,124	4,00	30,00	0,428	1,00	30,00
20	5°	0,064	20,00	20,00	0,112	4,00	40,00	0,385	1,00	40,00
20	5°	0,064	20,00	20,00	0,112	4,00	40,00	0,385	1,00	40,00
20	5°	0,080	20,00	20,00	0,124	4,00	30,00	0,428	1,00	30,00
20	5°	0,080	20,00	20,00	0,124	4,00	30,00	0,428	1,00	30,00
20	5°	0,064	20,00	20,00	0,112	4,00	40,00	0,385	1,00	40,00
20	5°	0,064	20,00	20,00	0,112	4,00	40,00	0,385	1,00	40,00
20	5°	0,080	20,00	20,00	0,124	4,00	30,00	0,428	1,00	30,00
20	5°	0,080	20,00	20,00	0,124	4,00	30,00	0,428	1,00	30,00
20	5°	0,064	20,00	20,00	0,112	4,00	40,00	0,385	1,00	40,00
20	5°	0,064	20,00	20,00	0,112	4,00	40,00	0,385	1,00	40,00
20	5°	0,080	20,00	20,00	0,124	4,00	30,00	0,428	1,00	30,00
20	5°	0,080	20,00	20,00	0,124	4,00	30,00	0,428	1,00	30,00
20	5°	0,064	20,00	20,00	0,112	4,00	40,00	0,385	1,00	40,00
20	5°	0,064	20,00	20,00	0,112	4,00	40,00	0,385	1,00	40,00
20	5°	0,080	20,00	20,00	0,124	4,00	30,00	0,428	1,00	30,00
20	5°	0,080	20,00	20,00	0,124	4,00	30,00	0,428	1,00	30,00
20	5°	0,064	20,00	20,00	0,112	4,00	40,00	0,385	1,00	40,00
20	5°	0,064	20,00	20,00	0,112	4,00	40,00	0,385	1,00	40,00
20	5°	0,080	20,00	20,00	0,124	4,00	30,00	0,428	1,00	30,00
20	5°	0,080	20,00	20,00	0,124	4,00	30,00	0,428	1,00	30,00
20	5°	0,064	20,00	20,00	0,112	4,00	40,00	0,385	1,00	40,00
20	5°	0,064	20,00	20,00	0,112	4,00	40,00	0,404	1,00	40,00

B

Abmessungen in mm
Dimensions in mm

Schaftfräser

End Mill



DSRV

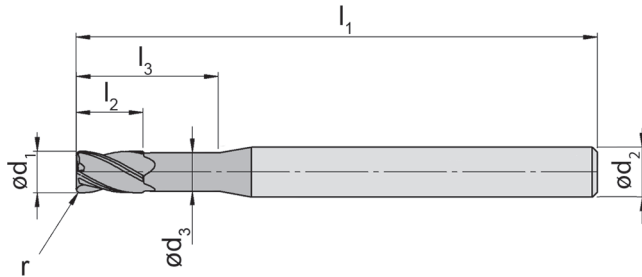
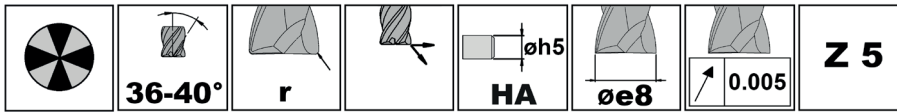

Bis Ø 3 mm vormontiert lieferbar für Toodle Schnelllaufspindel
Pre-assembled available up to Ø 3 mm for Toodle high-speed spindle

B

Bestellnummer Part number	d ₁	r	l ₂	l ₃	d ₃	d ₂	l ₁	Z	γ	Form Form	TSTK
DSRV.5.020.010.20	2	0,1	3	4	1,90	6	50	5	40°	HA	▲
DSRV.5.020.010.30	2	0,1	5	6	1,90	6	50	5	40°	HA	▲
DSRV.5.020.020.20	2	0,2	3	4	1,90	6	50	5	40°	HA	▲
DSRV.5.020.020.30	2	0,2	5	6	1,90	6	50	5	40°	HA	▲
DSRV.5.030.010.20	3	0,1	5	6	2,85	6	50	5	40°	HA	▲
DSRV.5.030.010.30	3	0,1	7	9	2,85	6	50	5	40°	HA	▲
DSRV.5.030.020.20	3	0,2	5	6	2,85	6	50	5	40°	HA	▲
DSRV.5.030.020.30	3	0,2	7	9	2,85	6	50	5	40°	HA	▲
DSRV.5.030.050.20	3	0,5	5	6	2,85	6	50	5	40°	HA	▲
DSRV.5.030.050.30	3	0,5	7	9	2,85	6	50	5	40°	HA	▲
DSRV.5.040.010.20	4	0,1	6	8	3,80	6	50	5	40°	HA	▲
DSRV.5.040.010.30	4	0,1	9	12	3,80	6	57	5	40°	HA	▲
DSRV.5.040.020.20	4	0,2	6	8	3,80	6	50	5	40°	HA	▲
DSRV.5.040.020.30	4	0,2	9	12	3,80	6	57	5	40°	HA	▲
DSRV.5.040.050.20	4	0,5	6	8	3,80	6	50	5	40°	HA	▲
DSRV.5.040.050.30	4	0,5	9	12	3,80	6	57	5	40°	HA	▲
DSRV.5.050.010.20	5	0,1	8	10	4,75	6	50	5	40°	HA	▲
DSRV.5.050.010.30	5	0,1	11	15	4,75	6	57	5	40°	HA	▲
DSRV.5.050.020.20	5	0,2	8	10	4,75	6	50	5	40°	HA	▲
DSRV.5.050.020.30	5	0,2	11	15	4,75	6	57	5	40°	HA	▲
DSRV.5.050.050.20	5	0,5	8	10	4,75	6	50	5	40°	HA	▲
DSRV.5.050.050.30	5	0,5	11	15	4,75	6	57	5	40°	HA	▲
DSRV.5.050.100.20	5	1,0	8	10	4,75	6	50	5	40°	HA	▲
DSRV.5.050.100.30	5	1,0	11	15	4,75	6	57	5	40°	HA	▲

▲ ab Lager / on stock Δ 4 Wochen / 4 weeks x auf Anfrage / upon request

● empfohlen / recommended

o bedingt einsetzbar / alternative recommendation

- nicht geeignet / not suitable

■ unbeschichtete HM-Sorten / uncoated grades

■ beschichtete HM-Sorten / coated grades

■ bestückt/Cermet / brazed/Cermet

Abmessungen in mm

Dimensions in mm

P	•
M	•
K	○
N	-
S	•
H	-





HM-Sorten
Carbide grades

Schnittdaten DSRV Ø 2,0 - 4,0 mm

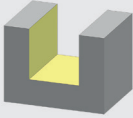
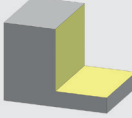
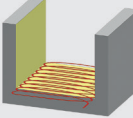
Cutting Data DSRV Ø 2,0 - 4,0 mm



	 vc = m/min	 vc = m/min	 vc = m/min
M1.1	100	130	190
M2.1	80	100	150
M3.1	70	90	130
S1.1	60	80	120
S2.1	40	50	70
S3.1	33	40	60

d ₁										
		f _z	a _e	a _p	f _z	a _e	a _p	f _z	a _e	a _p
2	3°	0,007	2,00	2,00	0,009	0,40	3,00	0,035	0,10	3,00
2	3°	0,005	2,00	2,00	0,004	0,40	4,00	0,032	0,10	4,00
2	3°	0,007	2,00	2,00	0,009	0,40	3,00	0,035	0,10	3,00
2	3°	0,005	2,00	2,00	0,004	0,40	4,00	0,032	0,10	4,00
3	3°	0,011	3,00	3,00	0,016	0,60	4,50	0,057	0,15	4,50
3	3°	0,008	3,00	3,00	0,010	0,60	6,00	0,051	0,15	6,00
3	3°	0,011	3,00	3,00	0,016	0,60	4,50	0,057	0,15	4,50
3	3°	0,008	3,00	3,00	0,010	0,60	6,00	0,051	0,15	6,00
3	3°	0,011	3,00	3,00	0,016	0,60	4,50	0,057	0,15	4,50
3	3°	0,008	3,00	3,00	0,010	0,60	6,00	0,051	0,15	6,00
4	3°	0,015	4,00	4,00	0,022	0,80	6,00	0,078	0,20	6,00
4	3°	0,012	4,00	4,00	0,016	0,80	8,00	0,070	0,20	8,00
4	3°	0,015	4,00	4,00	0,022	0,80	6,00	0,078	0,20	6,00
4	3°	0,012	4,00	4,00	0,016	0,80	8,00	0,070	0,20	8,00
4	3°	0,015	4,00	4,00	0,022	0,80	6,00	0,078	0,20	6,00
4	3°	0,012	4,00	4,00	0,016	0,80	8,00	0,070	0,20	8,00

Abmessungen in mm
Dimensions in mm

B

DSRV

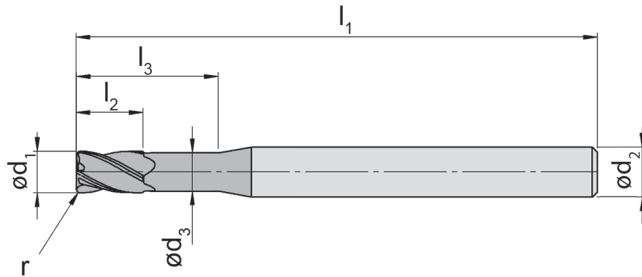
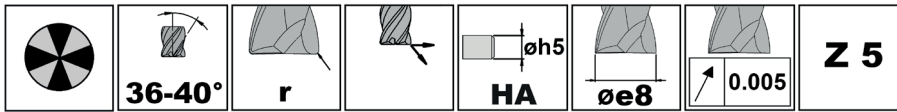

B

Bestellnummer Part number	d ₁	r	l ₂	l ₃	d ₃	d ₂	l ₁	Z	Form Form	TSTK
DSRV.5.060.010.20	6	0,1	9	12	5,7	6	50	5	HA	▲
DSRV.5.060.010.30	6	0,1	13	18	5,7	6	57	5	HA	▲
DSRV.5.060.020.20	6	0,2	9	12	5,7	6	50	5	HA	▲
DSRV.5.060.020.30	6	0,2	13	18	5,7	6	57	5	HA	▲
DSRV.5.060.050.20	6	0,5	9	12	5,7	6	50	5	HA	▲
DSRV.5.060.050.30	6	0,5	13	18	5,7	6	57	5	HA	▲
DSRV.5.060.100.20	6	1,0	9	12	5,7	6	50	5	HA	▲
DSRV.5.060.100.30	6	1,0	13	18	5,7	6	57	5	HA	▲
DSRV.5.080.010.20	8	0,1	12	16	7,6	8	58	5	HA	▲
DSRV.5.080.010.30	8	0,1	17	24	7,6	8	63	5	HA	▲
DSRV.5.080.020.20	8	0,2	12	16	7,6	8	58	5	HA	▲
DSRV.5.080.020.30	8	0,2	17	24	7,6	8	63	5	HA	▲
DSRV.5.080.050.20	8	0,5	12	16	7,6	8	58	5	HA	▲
DSRV.5.080.050.30	8	0,5	17	24	7,6	8	63	5	HA	▲
DSRV.5.080.100.20	8	1,0	12	16	7,6	8	58	5	HA	▲
DSRV.5.080.100.30	8	1,0	17	24	7,6	8	63	5	HA	▲
DSRV.5.080.150.20	8	1,5	12	16	7,6	8	58	5	HA	▲
DSRV.5.080.150.30	8	1,5	17	24	7,6	8	63	5	HA	▲

▲ ab Lager / on stock Δ 4 Wochen / 4 weeks x auf Anfrage / upon request

● empfohlen / recommended

o bedingt einsetzbar / alternative recommendation

- nicht geeignet / not suitable

■ unbeschichtete HM-Sorten / uncoated grades

■ beschichtete HM-Sorten / coated grades

■ bestückt/Cermet / brazed/Cermet

Abmessungen in mm

Dimensions in mm

P	•
M	•
K	o
N	-
S	•
H	-



HM-Sorten
Carbide grades

Schnittdaten DSRV Ø 6,0 - 8,0 mm

Cutting Data DSRV Ø 6,0 - 8,0 mm

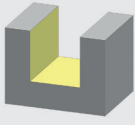
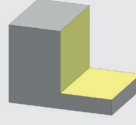
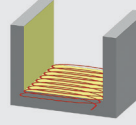

	 vc = m/min	 vc = m/min	 vc = m/min
M1.1	100	130	190
M2.1	80	100	150
M3.1	70	90	130
S1.1	60	80	120
S2.1	40	50	70
S3.1	33	40	60

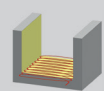
d ₁										
		f _z	a _e	a _p	f _z	a _e	a _p	f _z	a _e	a _p
6	3°	0,023	6,00	6,00	0,035	1,20	9,00	0,121	0,30	9,00
6	3°	0,018	6,00	6,00	0,027	1,20	12,00	0,108	0,30	12,00
6	3°	0,023	6,00	6,00	0,035	1,20	9,00	0,121	0,30	9,00
6	3°	0,018	6,00	6,00	0,027	1,20	12,00	0,108	0,30	12,00
6	3°	0,023	6,00	6,00	0,035	1,20	9,00	0,121	0,30	9,00
6	3°	0,018	6,00	6,00	0,027	1,20	12,00	0,108	0,30	12,00
6	3°	0,023	6,00	6,00	0,035	1,20	9,00	0,121	0,30	9,00
6	3°	0,018	6,00	6,00	0,027	1,20	12,00	0,108	0,30	12,00
8	3°	0,031	8,00	8,00	0,047	1,60	12,00	0,163	0,40	12,00
8	3°	0,024	8,00	8,00	0,039	1,60	16,00	0,147	0,40	16,00
8	3°	0,031	8,00	8,00	0,047	1,60	12,00	0,163	0,40	12,00
8	3°	0,024	8,00	8,00	0,039	1,60	16,00	0,147	0,40	16,00
8	3°	0,031	8,00	8,00	0,047	1,60	12,00	0,163	0,40	12,00
8	3°	0,024	8,00	8,00	0,039	1,60	16,00	0,147	0,40	16,00
8	3°	0,031	8,00	8,00	0,047	1,60	12,00	0,163	0,40	12,00
8	3°	0,024	8,00	8,00	0,039	1,60	16,00	0,147	0,40	16,00
8	3°	0,031	8,00	8,00	0,047	1,60	12,00	0,163	0,40	12,00
8	3°	0,024	8,00	8,00	0,039	1,60	16,00	0,147	0,40	16,00

Abmessungen in mm
Dimensions in mm

B

Schaftfräser

End Mill



DSRV

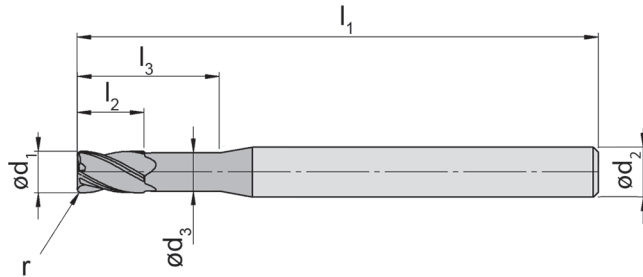
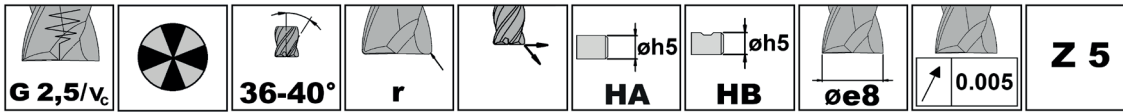

B

Bestellnummer Part number	d ₁	r	l ₂	l ₃	d ₃	d ₂	l ₁	Z	Form Form	TSTK
DSRV.5.100.010.20	10	0,1	15	20	9,5	10	66	5	HA	▲
DSRV.5.100.010.20B	10	0,1	15	20	9,5	10	66	5	HB	▲
DSRV.5.100.010.30	10	0,1	21	30	9,5	10	72	5	HA	▲
DSRV.5.100.010.30B	10	0,1	21	30	9,5	10	72	5	HB	▲
DSRV.5.100.020.20	10	0,2	15	20	9,5	10	66	5	HA	▲
DSRV.5.100.020.20B	10	0,2	15	20	9,5	10	66	5	HB	▲
DSRV.5.100.020.30	10	0,2	21	30	9,5	10	72	5	HA	▲
DSRV.5.100.020.30B	10	0,2	21	30	9,5	10	72	5	HB	▲
DSRV.5.100.050.20	10	0,5	15	20	9,5	10	66	5	HA	▲
DSRV.5.100.050.20B	10	0,5	15	20	9,5	10	66	5	HB	▲
DSRV.5.100.050.30B	10	0,5	21	30	9,5	10	72	5	HB	▲
DSRV.5.100.050.30	10	0,5	21	30	9,5	10	72	5	HA	▲
DSRV.5.100.100.20	10	1,0	15	20	9,5	10	66	5	HA	▲
DSRV.5.100.100.20B	10	1,0	15	20	9,5	10	66	5	HB	▲
DSRV.5.100.100.30	10	1,0	21	30	9,5	10	72	5	HA	▲
DSRV.5.100.100.30B	10	1,0	21	30	9,5	10	72	5	HB	▲
DSRV.5.100.150.20	10	1,5	15	20	9,5	10	66	5	HA	▲
DSRV.5.100.150.20B	10	1,5	15	20	9,5	10	66	5	HB	▲
DSRV.5.100.150.30	10	1,5	21	30	9,5	10	72	5	HA	▲
DSRV.5.100.150.30B	10	1,5	21	30	9,5	10	72	5	HB	▲
DSRV.5.100.200.20	10	2,0	15	20	9,5	10	66	5	HA	▲
DSRV.5.100.200.20B	10	2,0	15	20	9,5	10	66	5	HB	▲
DSRV.5.100.200.30	10	2,0	21	30	9,5	10	72	5	HA	▲
DSRV.5.100.200.30B	10	2,0	21	30	9,5	10	72	5	HB	▲
DSRV.5.100.250.20	10	2,5	15	20	9,5	10	66	5	HA	▲
DSRV.5.100.250.20B	10	2,5	15	20	9,5	10	66	5	HB	▲
DSRV.5.100.250.30	10	2,5	21	30	9,5	10	72	5	HA	▲
DSRV.5.100.250.30B	10	2,5	21	30	9,5	10	72	5	HB	▲
DSRV.5.100.300.20	10	3,0	15	20	9,5	10	66	5	HA	▲
DSRV.5.100.300.20B	10	3,0	15	20	9,5	10	66	5	HB	▲
DSRV.5.100.300.30	10	3,0	21	30	9,5	10	72	5	HA	▲
DSRV.5.100.300.30B	10	3,0	21	30	9,5	10	72	5	HB	▲

▲ ab Lager / on stock Δ 4 Wochen / 4 weeks x auf Anfrage / upon request

● empfohlen / recommended

o bedingt einsetzbar / alternative recommendation

- nicht geeignet / not suitable

■ unbeschichtete HM-Sorten / uncoated grades

■ beschichtete HM-Sorten / coated grades

■ bestückt/Cermet / brazed/Cermet

Abmessungen in mm

Dimensions in mm





P	•
M	•
K	•
N	-
S	•
H	-

Schnittdaten DSRV Ø 10 mm

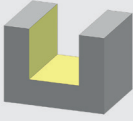
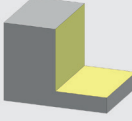
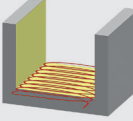
Cutting Data DSRV Ø 10 mm



	 vc = m/min	 vc = m/min	 vc = m/min
M1.1	100	130	190
M2.1	80	100	150
M3.1	70	90	130
S1.1	60	80	120
S2.1	40	50	70
S3.1	33	40	60

d ₁										
		f _z	a _e	a _p	f _z	a _e	a _p	f _z	a _e	a _p
10	3°	0,039	10,00	10,00	0,060	2,00	15,00	0,206	0,50	15,00
10	3°	0,038	10,00	10,00	0,056	2,00	15,00	0,206	0,50	15,00
10	3°	0,032	10,00	10,00	0,054	2,00	20,00	0,185	0,50	20,00
10	3°	0,031	10,00	10,00	0,050	2,00	20,00	0,185	0,50	20,00
10	3°	0,039	10,00	10,00	0,060	2,00	15,00	0,206	0,50	15,00
10	3°	0,038	10,00	10,00	0,056	2,00	15,00	0,206	0,50	15,00
10	3°	0,032	10,00	10,00	0,054	2,00	20,00	0,185	0,50	20,00
10	3°	0,031	10,00	10,00	0,050	2,00	20,00	0,185	0,50	20,00
10	3°	0,039	10,00	10,00	0,060	2,00	15,00	0,206	0,50	15,00
10	3°	0,038	10,00	10,00	0,056	2,00	15,00	0,206	0,50	15,00
10	3°	0,032	10,00	10,00	0,054	2,00	20,00	0,185	0,50	20,00
10	3°	0,031	10,00	10,00	0,050	2,00	20,00	0,185	0,50	20,00
10	3°	0,039	10,00	10,00	0,060	2,00	15,00	0,206	0,50	15,00
10	3°	0,038	10,00	10,00	0,056	2,00	15,00	0,206	0,50	15,00
10	3°	0,032	10,00	10,00	0,054	2,00	20,00	0,185	0,50	20,00
10	3°	0,031	10,00	10,00	0,050	2,00	20,00	0,185	0,50	20,00
10	3°	0,039	10,00	10,00	0,060	2,00	15,00	0,206	0,50	15,00
10	3°	0,038	10,00	10,00	0,056	2,00	15,00	0,206	0,50	15,00
10	3°	0,032	10,00	10,00	0,054	2,00	20,00	0,185	0,50	20,00
10	3°	0,031	10,00	10,00	0,050	2,00	20,00	0,185	0,50	20,00
10	3°	0,039	10,00	10,00	0,060	2,00	15,00	0,206	0,50	15,00
10	3°	0,038	10,00	10,00	0,056	2,00	15,00	0,206	0,50	15,00
10	3°	0,032	10,00	10,00	0,054	2,00	20,00	0,185	0,50	20,00
10	3°	0,031	10,00	10,00	0,050	2,00	20,00	0,185	0,50	20,00
10	3°	0,039	10,00	10,00	0,060	2,00	15,00	0,206	0,50	15,00
10	3°	0,038	10,00	10,00	0,056	2,00	15,00	0,206	0,50	15,00
10	3°	0,032	10,00	10,00	0,054	2,00	20,00	0,185	0,50	20,00
10	3°	0,031	10,00	10,00	0,050	2,00	20,00	0,185	0,50	20,00
10	3°	0,039	10,00	10,00	0,060	2,00	15,00	0,206	0,50	15,00
10	3°	0,038	10,00	10,00	0,056	2,00	15,00	0,206	0,50	15,00
10	3°	0,032	10,00	10,00	0,054	2,00	20,00	0,185	0,50	20,00
10	3°	0,031	10,00	10,00	0,050	2,00	20,00	0,185	0,50	20,00

Abmessungen in mm
Dimensions in mm

B

DSRV

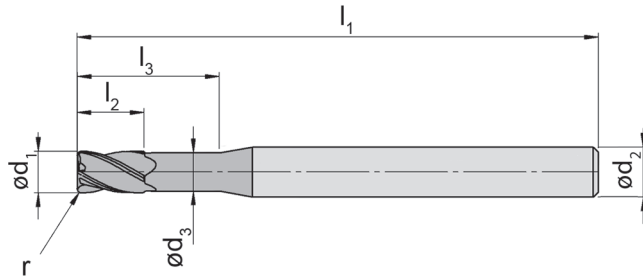
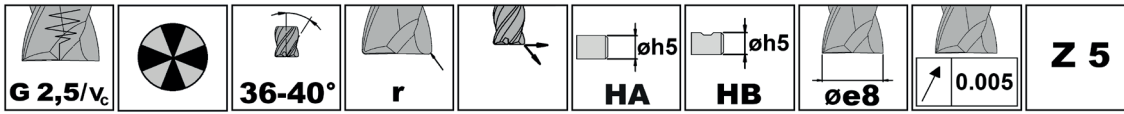

B

Bestellnummer Part number	d ₁	r	l ₂	l ₃	d ₃	d ₂	l ₁	Z	Form Form	TSTK
DSRV.5.120.020.20	12	0,2	18	24	11,4	12	73	5	HA	▲
DSRV.5.120.020.20B	12	0,2	18	24	11,4	12	73	5	HB	▲
DSRV.5.120.020.30	12	0,2	26	36	11,4	12	83	5	HA	▲
DSRV.5.120.020.30B	12	0,2	26	36	11,4	12	83	5	HB	▲
DSRV.5.120.050.20	12	0,5	18	24	11,4	12	73	5	HA	▲
DSRV.5.120.050.20B	12	0,5	18	24	11,4	12	73	5	HB	▲
DSRV.5.120.050.30	12	0,5	26	36	11,4	12	83	5	HA	▲
DSRV.5.120.050.30B	12	0,5	26	36	11,4	12	83	5	HB	▲
DSRV.5.120.100.20	12	1,0	18	24	11,4	12	73	5	HA	▲
DSRV.5.120.100.20B	12	1,0	18	24	11,4	12	73	5	HB	▲
DSRV.5.120.100.30	12	1,0	26	36	11,4	12	83	5	HA	▲
DSRV.5.120.100.30B	12	1,0	26	36	11,4	12	83	5	HB	▲
DSRV.5.120.150.20	12	1,5	18	24	11,4	12	73	5	HA	▲
DSRV.5.120.150.20B	12	1,5	18	24	11,4	12	73	5	HB	▲
DSRV.5.120.150.30	12	1,5	26	36	11,4	12	83	5	HA	▲
DSRV.5.120.150.30B	12	1,5	26	36	11,4	12	83	5	HB	▲
DSRV.5.120.200.20	12	2,0	18	24	11,4	12	73	5	HA	▲
DSRV.5.120.200.20B	12	2,0	18	24	11,4	12	73	5	HB	▲
DSRV.5.120.200.30	12	2,0	26	36	11,4	12	83	5	HA	▲
DSRV.5.120.200.30B	12	2,0	26	36	11,4	12	83	5	HB	▲
DSRV.5.120.250.20	12	2,5	18	24	11,4	12	73	5	HA	▲
DSRV.5.120.250.20B	12	2,5	18	24	11,4	12	73	5	HB	▲
DSRV.5.120.250.30	12	2,5	26	36	11,4	12	83	5	HA	▲
DSRV.5.120.250.30B	12	2,5	26	36	11,4	12	83	5	HB	▲
DSRV.5.120.300.20	12	3,0	18	24	11,4	12	73	5	HA	▲
DSRV.5.120.300.20B	12	3,0	18	24	11,4	12	73	5	HB	▲
DSRV.5.120.300.30	12	3,0	26	36	11,4	12	83	5	HA	▲
DSRV.5.120.300.30B	12	3,0	26	36	11,4	12	83	5	HB	▲

▲ ab Lager / on stock Δ 4 Wochen / 4 weeks x auf Anfrage / upon request

● empfohlen / recommended

o bedingt einsetzbar / alternative recommendation

- nicht geeignet / not suitable

■ unbeschichtete HM-Sorten / uncoated grades

■ beschichtete HM-Sorten / coated grades

■ bestückt/Cermet / brazed/Cermet

Abmessungen in mm

Dimensions in mm

P	•
M	•
K	•
N	-
S	•
H	-



HM-Sorten
Carbide grades

Schnittdaten DSRV Ø 12 mm

Cutting Data DSRV Ø 12 mm

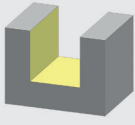
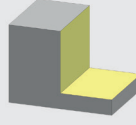
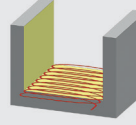

	 vc = m/min	 vc = m/min	 vc = m/min
M1.1	100	130	190
M2.1	80	100	150
M3.1	70	90	130
S1.1	60	80	120
S2.1	40	50	70
S3.1	33	40	60

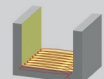
d ₁										
		f _z	a _e	a _p	f _z	a _e	a _p	f _z	a _e	a _p
12	3°	0,047	12,00	12,00	0,073	2,40	18,00	0,248	0,60	18,00
12	3°	0,046	12,00	12,00	0,069	2,40	18,00	0,248	0,60	18,00
12	3°	0,038	12,00	12,00	0,066	2,40	24,00	0,223	0,60	24,00
12	3°	0,037	12,00	12,00	0,062	2,40	24,00	0,223	0,60	24,00
12	3°	0,047	12,00	12,00	0,073	2,40	18,00	0,248	0,60	18,00
12	3°	0,046	12,00	12,00	0,069	2,40	18,00	0,248	0,60	18,00
12	3°	0,038	12,00	12,00	0,066	2,40	24,00	0,223	0,60	24,00
12	3°	0,037	12,00	12,00	0,062	2,40	24,00	0,223	0,60	24,00
12	3°	0,047	12,00	12,00	0,073	2,40	18,00	0,248	0,60	18,00
12	3°	0,046	12,00	12,00	0,069	2,40	18,00	0,248	0,60	18,00
12	3°	0,038	12,00	12,00	0,066	2,40	24,00	0,223	0,60	24,00
12	3°	0,037	12,00	12,00	0,062	2,40	24,00	0,223	0,60	24,00
12	3°	0,047	12,00	12,00	0,073	2,40	18,00	0,248	0,60	18,00
12	3°	0,046	12,00	12,00	0,069	2,40	18,00	0,248	0,60	18,00
12	3°	0,038	12,00	12,00	0,066	2,40	24,00	0,223	0,60	24,00
12	3°	0,037	12,00	12,00	0,062	2,40	24,00	0,223	0,60	24,00
12	3°	0,047	12,00	12,00	0,073	2,40	18,00	0,248	0,60	18,00
12	3°	0,046	12,00	12,00	0,069	2,40	18,00	0,248	0,60	18,00
12	3°	0,038	12,00	12,00	0,066	2,40	24,00	0,223	0,60	24,00
12	3°	0,037	12,00	12,00	0,062	2,40	24,00	0,223	0,60	24,00
12	3°	0,047	12,00	12,00	0,073	2,40	18,00	0,248	0,60	18,00
12	3°	0,046	12,00	12,00	0,069	2,40	18,00	0,248	0,60	18,00
12	3°	0,038	12,00	12,00	0,066	2,40	24,00	0,223	0,60	24,00
12	3°	0,037	12,00	12,00	0,062	2,40	24,00	0,223	0,60	24,00

Abmessungen in mm
Dimensions in mm

B

Schaftfräser

End Mill



DSRV

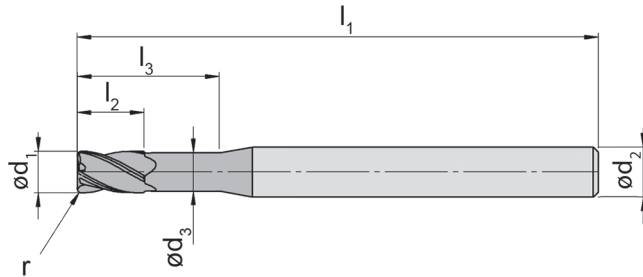
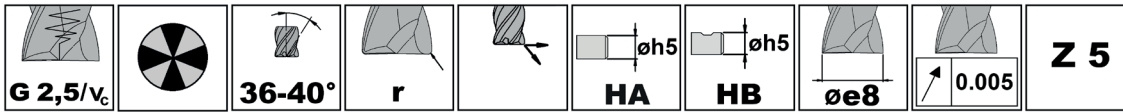

B

Bestellnummer Part number	d ₁	r	l ₂	l ₃	d ₃	d ₂	l ₁	Z	Form Form	TSTK
DSRV.5.160.020.20	16	0,2	24	32	15,2	16	82	5	HA	▲
DSRV.5.160.020.20B	16	0,2	24	32	15,2	16	82	5	HB	▲
DSRV.5.160.020.30	16	0,2	34	48	15,2	16	100	5	HA	▲
DSRV.5.160.020.30B	16	0,2	34	48	15,2	16	100	5	HB	▲
DSRV.5.160.050.20	16	0,5	24	32	15,2	16	82	5	HA	▲
DSRV.5.160.050.20B	16	0,5	24	32	15,2	16	82	5	HB	▲
DSRV.5.160.050.30	16	0,5	34	48	15,2	16	100	5	HA	▲
DSRV.5.160.050.30B	16	0,5	34	48	15,2	16	100	5	HB	▲
DSRV.5.160.100.20	16	1,0	24	32	15,2	16	82	5	HA	▲
DSRV.5.160.100.20B	16	1,0	24	32	15,2	16	82	5	HB	▲
DSRV.5.160.100.30	16	1,0	34	48	15,2	16	100	5	HA	▲
DSRV.5.160.100.30B	16	1,0	34	48	15,2	16	100	5	HB	▲
DSRV.5.160.150.20	16	1,5	24	32	15,2	16	82	5	HA	▲
DSRV.5.160.150.20B	16	1,5	24	32	15,2	16	82	5	HB	▲
DSRV.5.160.150.30	16	1,5	34	48	15,2	16	100	5	HA	▲
DSRV.5.160.150.30B	16	1,5	34	48	15,2	16	100	5	HB	▲
DSRV.5.160.200.20	16	2,0	24	32	15,2	16	82	5	HA	▲
DSRV.5.160.200.20B	16	2,0	24	32	15,2	16	82	5	HB	▲
DSRV.5.160.200.30B	16	2,0	34	48	15,2	16	100	5	HB	▲
DSRV.5.160.200.30	16	2,0	34	48	15,2	16	100	5	HA	▲
DSRV.5.160.250.20	16	2,5	24	32	15,2	16	82	5	HA	▲
DSRV.5.160.250.20B	16	2,5	24	32	15,2	16	82	5	HB	▲
DSRV.5.160.250.30	16	2,5	34	48	15,2	16	100	5	HA	▲
DSRV.5.160.250.30B	16	2,5	34	48	15,2	16	100	5	HB	▲
DSRV.5.160.300.20	16	3,0	24	32	15,2	16	82	5	HA	▲
DSRV.5.160.300.20B	16	3,0	24	32	15,2	16	82	5	HB	▲
DSRV.5.160.300.30	16	3,0	34	48	15,2	16	100	5	HA	▲
DSRV.5.160.300.30B	16	3,0	34	48	15,2	16	100	5	HB	▲
DSRV.5.160.400.20	16	4,0	24	32	15,2	16	82	5	HA	▲
DSRV.5.160.400.20B	16	4,0	24	32	15,2	16	82	5	HB	▲
DSRV.5.160.400.30	16	4,0	34	48	15,2	16	100	5	HA	▲
DSRV.5.160.400.30B	16	4,0	34	48	15,2	16	100	5	HB	▲

▲ ab Lager / on stock Δ 4 Wochen / 4 weeks x auf Anfrage / upon request

● empfohlen / recommended

o bedingt einsetzbar / alternative recommendation

- nicht geeignet / not suitable

■ unbeschichtete HM-Sorten / uncoated grades

■ beschichtete HM-Sorten / coated grades

■ bestückt/Cermet / brazed/Cermet

Abmessungen in mm

Dimensions in mm





P	•
M	•
K	•
N	-
S	•
H	-

Schnittdaten DSRV Ø 16 mm

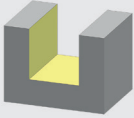
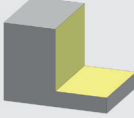
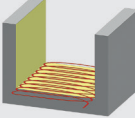
Cutting Data DSRV Ø 16 mm



	 vc = m/min	 vc = m/min	 vc = m/min
M1.1	100	130	190
M2.1	80	100	150
M3.1	70	90	130
S1.1	60	80	120
S2.1	40	50	70
S3.1	33	40	60

d_1										
		f_z	a_e	a_p	f_z	a_e	a_p	f_z	a_e	a_p
16	3°	0,063	16,00	16,00	0,099	3,20	24,00	0,333	0,80	24,00
16	3°	0,062	16,00	16,00	0,094	3,20	24,00	0,333	0,80	24,00
16	3°	0,051	16,00	16,00	0,089	3,20	32,00	0,300	0,80	32,00
16	3°	0,050	16,00	16,00	0,085	3,20	32,00	0,300	0,80	32,00
16	3°	0,063	16,00	16,00	0,099	3,20	24,00	0,333	0,80	24,00
16	3°	0,062	16,00	16,00	0,094	3,20	24,00	0,333	0,80	24,00
16	3°	0,051	16,00	16,00	0,089	3,20	32,00	0,300	0,80	32,00
16	3°	0,050	16,00	16,00	0,085	3,20	32,00	0,300	0,80	32,00
16	3°	0,063	16,00	16,00	0,099	3,20	24,00	0,333	0,80	24,00
16	3°	0,062	16,00	16,00	0,094	3,20	24,00	0,333	0,80	24,00
16	3°	0,051	16,00	16,00	0,089	3,20	32,00	0,300	0,80	32,00
16	3°	0,050	16,00	16,00	0,085	3,20	32,00	0,300	0,80	32,00
16	3°	0,063	16,00	16,00	0,099	3,20	24,00	0,333	0,80	24,00
16	3°	0,062	16,00	16,00	0,094	3,20	24,00	0,333	0,80	24,00
16	3°	0,051	16,00	16,00	0,089	3,20	32,00	0,300	0,80	32,00
16	3°	0,050	16,00	16,00	0,085	3,20	32,00	0,300	0,80	32,00
16	3°	0,063	16,00	16,00	0,099	3,20	24,00	0,333	0,80	24,00
16	3°	0,062	16,00	16,00	0,094	3,20	24,00	0,333	0,80	24,00
16	3°	0,051	16,00	16,00	0,089	3,20	32,00	0,300	0,80	32,00
16	3°	0,050	16,00	16,00	0,085	3,20	32,00	0,300	0,80	32,00
16	3°	0,063	16,00	16,00	0,099	3,20	24,00	0,333	0,80	24,00
16	3°	0,062	16,00	16,00	0,094	3,20	24,00	0,333	0,80	24,00
16	3°	0,051	16,00	16,00	0,089	3,20	32,00	0,300	0,80	32,00
16	3°	0,050	16,00	16,00	0,085	3,20	32,00	0,300	0,80	32,00
16	3°	0,063	16,00	16,00	0,099	3,20	24,00	0,333	0,80	24,00
16	3°	0,062	16,00	16,00	0,094	3,20	24,00	0,333	0,80	24,00
16	3°	0,051	16,00	16,00	0,089	3,20	32,00	0,300	0,80	32,00
16	3°	0,050	16,00	16,00	0,085	3,20	32,00	0,300	0,80	32,00
16	3°	0,063	16,00	16,00	0,099	3,20	24,00	0,333	0,80	24,00
16	3°	0,062	16,00	16,00	0,094	3,20	24,00	0,333	0,80	24,00
16	3°	0,051	16,00	16,00	0,089	3,20	32,00	0,300	0,80	32,00
16	3°	0,050	16,00	16,00	0,085	3,20	32,00	0,300	0,80	32,00

Abmessungen in mm
Dimensions in mm

B

Schaftfräser

End Mill



DSRV

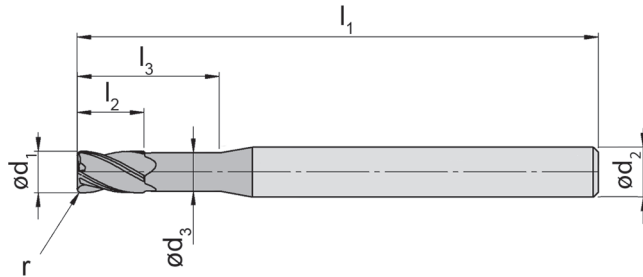
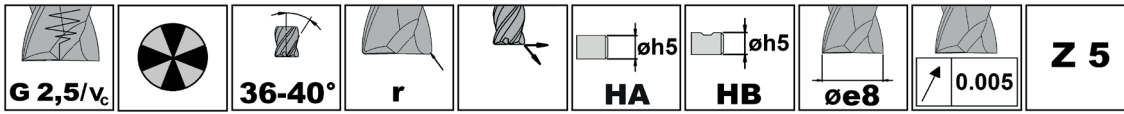

B

Bestellnummer Part number	d ₁	r	l ₂	l ₃	d ₃	d ₂	l ₁	Z	Form Form	TSTK
DSRV.5.200.020.20	20	0,2	30	40	19	20	92	5	HA	▲
DSRV.5.200.020.20B	20	0,2	30	40	19	20	92	5	HB	▲
DSRV.5.200.020.30	20	0,2	42	60	19	20	120	5	HA	▲
DSRV.5.200.020.30B	20	0,2	42	60	19	20	120	5	HB	▲
DSRV.5.200.050.20	20	0,5	30	40	19	20	92	5	HA	▲
DSRV.5.200.050.20B	20	0,5	30	40	19	20	92	5	HB	▲
DSRV.5.200.050.30	20	0,5	42	60	19	20	120	5	HA	▲
DSRV.5.200.050.30B	20	0,5	42	60	19	20	120	5	HB	▲
DSRV.5.200.100.20	20	1,0	30	40	19	20	92	5	HA	▲
DSRV.5.200.100.20B	20	1,0	30	40	19	20	92	5	HB	▲
DSRV.5.200.100.30	20	1,0	42	60	19	20	120	5	HA	▲
DSRV.5.200.100.30B	20	1,0	42	60	19	20	120	5	HB	▲
DSRV.5.200.150.20	20	1,5	30	40	19	20	92	5	HA	▲
DSRV.5.200.150.20B	20	1,5	30	40	19	20	92	5	HB	▲
DSRV.5.200.150.30	20	1,5	42	60	19	20	120	5	HA	▲
DSRV.5.200.150.30B	20	1,5	42	60	19	20	120	5	HB	▲
DSRV.5.200.200.20	20	2,0	30	40	19	20	92	5	HA	▲
DSRV.5.200.200.20B	20	2,0	30	40	19	20	92	5	HB	▲
DSRV.5.200.200.30	20	2,0	42	60	19	20	120	5	HA	▲
DSRV.5.200.200.30B	20	2,0	42	60	19	20	120	5	HB	▲
DSRV.5.200.250.20B	20	2,5	30	40	19	20	92	5	HB	▲
DSRV.5.200.250.20	20	2,5	30	40	19	20	92	5	HA	▲
DSRV.5.200.250.30	20	2,5	42	60	19	20	120	5	HA	▲
DSRV.5.200.250.30B	20	2,5	42	60	19	20	120	5	HB	▲
DSRV.5.200.300.20	20	3,0	30	40	19	20	92	5	HA	▲
DSRV.5.200.300.20B	20	3,0	30	40	19	20	92	5	HB	▲
DSRV.5.200.300.30	20	3,0	42	60	19	20	120	5	HA	▲
DSRV.5.200.300.30B	20	3,0	42	60	19	20	120	5	HB	▲
DSRV.5.200.400.20	20	4,0	30	40	19	20	92	5	HA	▲
DSRV.5.200.400.20B	20	4,0	30	40	19	20	92	5	HB	▲
DSRV.5.200.400.30	20	4,0	42	60	19	20	120	5	HA	▲
DSRV.5.200.400.30B	20	4,0	42	60	19	20	120	5	HB	▲

▲ ab Lager / on stock Δ 4 Wochen / 4 weeks x auf Anfrage / upon request

● empfohlen / recommended

o bedingt einsetzbar / alternative recommendation

- nicht geeignet / not suitable

■ unbeschichtete HM-Sorten / uncoated grades

■ beschichtete HM-Sorten / coated grades

■ bestückt/Cermet / brazed/Cermet

Abmessungen in mm

Dimensions in mm





P	•
M	•
K	◦
N	-
S	•
H	-

Schnittdaten DSRV Ø 20 mm

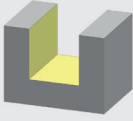
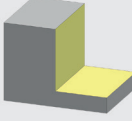
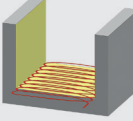
Cutting Data DSRV Ø 20 mm



	 vc = m/min	 vc = m/min	 vc = m/min
M1.1	100	130	190
M2.1	80	100	150
M3.1	70	90	130
S1.1	60	80	120
S2.1	40	50	70
S3.1	33	40	60

d ₁										
		f _z	a _e	a _p	f _z	a _e	a _p	f _z	a _e	a _p
20	3°	0,079	20,00	20,00	0,124	4,00	30,00	0,419	1,00	30,00
20	3°	0,078	20,00	20,00	0,120	4,00	30,00	0,419	1,00	30,00
20	3°	0,064	20,00	20,00	0,112	4,00	40,00	0,377	1,00	40,00
20	3°	0,063	20,00	20,00	0,108	4,00	40,00	0,377	1,00	40,00
20	3°	0,079	20,00	20,00	0,124	4,00	30,00	0,419	1,00	30,00
20	3°	0,078	20,00	20,00	0,120	4,00	30,00	0,419	1,00	30,00
20	3°	0,064	20,00	20,00	0,112	4,00	40,00	0,377	1,00	40,00
20	3°	0,063	20,00	20,00	0,108	4,00	40,00	0,377	1,00	40,00
20	3°	0,079	20,00	20,00	0,124	4,00	30,00	0,419	1,00	30,00
20	3°	0,078	20,00	20,00	0,120	4,00	30,00	0,419	1,00	30,00
20	3°	0,064	20,00	20,00	0,112	4,00	40,00	0,377	1,00	40,00
20	3°	0,063	20,00	20,00	0,108	4,00	40,00	0,377	1,00	40,00
20	3°	0,079	20,00	20,00	0,124	4,00	30,00	0,419	1,00	30,00
20	3°	0,078	20,00	20,00	0,120	4,00	30,00	0,419	1,00	30,00
20	3°	0,064	20,00	20,00	0,112	4,00	40,00	0,377	1,00	40,00
20	3°	0,063	20,00	20,00	0,108	4,00	40,00	0,377	1,00	40,00
20	3°	0,079	20,00	20,00	0,124	4,00	30,00	0,419	1,00	30,00
20	3°	0,078	20,00	20,00	0,120	4,00	30,00	0,419	1,00	30,00
20	3°	0,064	20,00	20,00	0,112	4,00	40,00	0,377	1,00	40,00
20	3°	0,063	20,00	20,00	0,108	4,00	40,00	0,377	1,00	40,00
20	3°	0,079	20,00	20,00	0,124	4,00	30,00	0,419	1,00	30,00
20	3°	0,078	20,00	20,00	0,120	4,00	30,00	0,419	1,00	30,00
20	3°	0,064	20,00	20,00	0,112	4,00	40,00	0,377	1,00	40,00
20	3°	0,063	20,00	20,00	0,108	4,00	40,00	0,377	1,00	40,00
20	3°	0,079	20,00	20,00	0,124	4,00	30,00	0,419	1,00	30,00
20	3°	0,078	20,00	20,00	0,120	4,00	30,00	0,419	1,00	30,00
20	3°	0,064	20,00	20,00	0,112	4,00	40,00	0,377	1,00	40,00
20	3°	0,063	20,00	20,00	0,108	4,00	40,00	0,377	1,00	40,00
20	3°	0,079	20,00	20,00	0,124	4,00	30,00	0,419	1,00	30,00
20	3°	0,078	20,00	20,00	0,120	4,00	30,00	0,419	1,00	30,00
20	3°	0,064	20,00	20,00	0,112	4,00	40,00	0,377	1,00	40,00
20	3°	0,063	20,00	20,00	0,108	4,00	40,00	0,377	1,00	40,00

Abmessungen in mm
Dimensions in mm

B

Vollhartmetall-Schaftfräser

Solid Carbide End Mills



	DSKMA	Mikrofräser Vollradius Ball Nose End Mill Micro	Ø 0,1 – Ø 3,0	Z 2	B152 – B157
	DSMA	Schaftfräser Mikro, scharfkantig End Mill Micro, sharp	Ø 0,1 – Ø 3,0	Z 2	B158 – B161
	DSTMA	Torusfräser Mikro Torus End Mill Micro	Ø 0,1 – Ø 3,0	Z 2	B162 – B167
	DSA.1	Schaftfräser Einscheider End Mill single fluted	Ø 0,3 – Ø 20,0	Z 1	B168 – B171
	DSKA	Schaftfräser Vollradius Ball Nose End Mill	Ø 4,0 – Ø 20,0	Z 2	B172 – B173
	DSA.3	Schaftfräser, scharfkantig End Mill, sharp	Ø 4,0 – Ø 20,0	Z 3	B174 – B175
	DSRA.3	Schaftfräser, Eckradius End Mill, Corner Radius	Ø 4,0 – Ø 20,0	Z 3	B176 – B183
	DSFA.3	HPC - Schaftfräser, Eckfase HPC - End Mill, chamfer	Ø 6,0 – Ø 20,0	Z 3	B184 – B175
	DSFRA.3	Kordelschruppfräser Roughing End Mill with ripper profile	Ø 6,0 – Ø 20,0	Z 3	B186 – B187

B

DS



B

abgestimmt für:

- Aluminium
- Kunststoff

designed for:

- Aluminium
- Synthetics

DSKMA

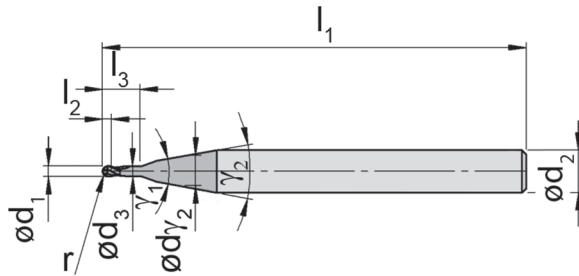

B

Bestellnummer Part number	d ₁	r	l ₂	l ₃	d ₃	d ₂	l ₁	Z	γ ₁	γ ₂	d _{γ₂}	MG3K
DSKMA.010.030	0,1	0,05	0,25	0,3	0,084	4	50	2	20°	-°	0	▲
DSKMA.010.050	0,1	0,05	0,25	0,5	0,084	4	50	2	40°	20°	2	▲
DSKMA.010.070	0,1	0,05	0,25	0,7	0,084	4	50	2	40°	20°	2	▲
DSKMA.020.030	0,2	0,10	0,50	0,6	0,180	4	50	2	20°	-°	0	▲
DSKMA.020.050	0,2	0,10	0,50	1,0	0,180	4	50	2	40°	20°	2	▲
DSKMA.020.070	0,2	0,10	0,50	1,4	0,180	4	50	2	40°	20°	2	▲
DSKMA.030.030	0,3	0,15	0,75	0,9	0,280	4	50	2	20°	-°	0	▲
DSKMA.030.050	0,3	0,15	0,75	1,5	0,280	4	50	2	40°	20°	2	▲
DSKMA.030.070	0,3	0,15	0,75	2,1	0,280	4	50	2	40°	20°	2	▲
DSKMA.050.030	0,5	0,25	1,25	1,5	0,470	4	50	2	20°	-°	0	▲
DSKMA.050.050	0,5	0,25	1,25	2,5	0,470	4	50	2	40°	20°	2	▲
DSKMA.050.070	0,5	0,25	1,25	3,5	0,470	4	50	2	40°	20°	2	▲
DSKMA.060.030	0,6	0,30	1,50	1,8	0,560	4	50	2	20°	-°	0	▲
DSKMA.060.050	0,6	0,30	1,50	3,0	0,560	4	50	2	40°	20°	2	▲
DSKMA.060.070	0,6	0,30	1,50	4,2	0,560	4	50	2	40°	20°	2	▲
DSKMA.080.030	0,8	0,40	2,00	2,4	0,750	4	50	2	20°	-°	0	▲
DSKMA.080.050	0,8	0,40	2,00	4,0	0,750	4	50	2	40°	20°	2	▲
DSKMA.080.070	0,8	0,40	2,00	5,6	0,750	4	50	2	40°	20°	2	▲

▲ ab Lager / on stock Δ 4 Wochen / 4 weeks x auf Anfrage / upon request

● empfohlen / recommended

o bedingt einsetzbar / alternative recommendation

- nicht geeignet / not suitable

■ unbeschichtete HM-Sorten / uncoated grades

■ beschichtete HM-Sorten / coated grades

■ bestückt/Cermet / brazed/Cermet

Abmessungen in mm

Dimensions in mm



P	-
M	-
K	-
N	•
S	-
H	-



HM-Sorten
Carbide grades

Schnittdaten DSKMA Ø 0,1 - 0,8 mm

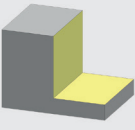
Cutting Data DSKMA Ø 0,1 - 0,8 mm

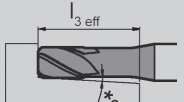

	 vc = m/min	 vc = m/min
N1.1	460	550
N1.2	480	580
N2.1	460	550
N2.2	390	470
N2.3	260	310
N3.1	330	400
N3.2	290	350
N4.1	330	400

d ₁												
		0°	0,5°	1°	2°	3°	f _z	a _e	a _p	f _z	a _e	a _p
0,1	7°	0,3	0,3	0,3	0,3	0,4	0,005	0,03	0,10	0,006	0,01	0,01
0,1	5°	0,5	0,5	0,5	0,5	0,5	0,004	0,03	0,10	0,005	0,01	0,01
0,1	3°	0,7	0,7	0,7	0,7	0,8	0,004	0,03	0,10	0,005	0,01	0,01
0,2	7°	0,6	0,6	0,6	0,7	0,8	0,006	0,06	0,20	0,007	0,01	0,02
0,2	5°	1,0	1,0	1,0	1,1	1,1	0,005	0,06	0,20	0,006	0,01	0,02
0,2	3°	1,4	1,4	1,4	1,5	1,6	0,004	0,06	0,20	0,006	0,01	0,01
0,3	7°	0,9	0,9	0,9	1,0	1,2	0,007	0,09	0,30	0,009	0,02	0,03
0,3	5°	1,5	1,5	1,5	1,6	1,7	0,006	0,09	0,30	0,008	0,02	0,02
0,3	3°	2,1	2,1	2,2	2,3	2,4	0,005	0,09	0,30	0,007	0,02	0,02
0,5	7°	1,5	1,5	1,6	1,8	2,0	0,009	0,15	0,50	0,012	0,03	0,05
0,5	5°	2,5	2,5	2,6	2,7	2,8	0,008	0,15	0,50	0,011	0,03	0,04
0,5	3°	3,5	3,5	3,6	3,8	4,0	0,007	0,15	0,50	0,009	0,03	0,03
0,6	7°	1,8	1,8	1,9	2,1	2,4	0,010	0,18	0,60	0,013	0,03	0,06
0,6	5°	3,0	3,0	3,1	3,2	3,4	0,009	0,18	0,60	0,012	0,03	0,05
0,6	3°	4,2	4,3	4,4	4,6	4,8	0,008	0,18	0,60	0,011	0,03	0,04
0,8	7°	2,4	2,5	2,6	2,9	3,2	0,012	0,24	0,80	0,016	0,04	0,08
0,8	5°	4,0	4,0	4,1	4,3	4,6	0,010	0,24	0,80	0,015	0,04	0,06
0,8	3°	5,6	5,7	5,8	6,1	6,4	0,009	0,24	0,80	0,013	0,04	0,05

Abmessungen in mm
Dimensions in mm



Mikrofräser Vollradius

Micro End Mill Ballnose



DSKMA

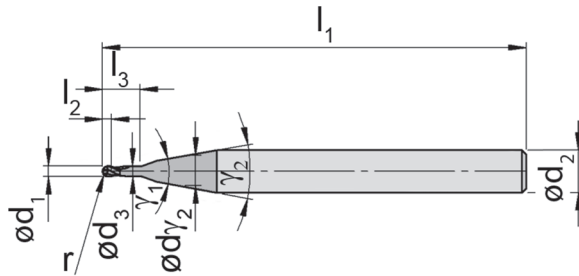

Bis Ø 3 mm vormontiert lieferbar für Toodle Schnelllaufspindel
Pre-assembled available up to Ø 3 mm for Toodle high-speed spindle

B

Bestellnummer Part number	d ₁	r	l ₂	l ₃	d ₃	d ₂	l ₁	Z	γ ₁	γ ₂	d _{v2}	MG3K
DSKMA.100.030	1,0	0,50	2,50	3,0	0,95	4	50	2	20°	-°	0	▲
DSKMA.100.050	1,0	0,50	2,50	5,0	0,95	4	50	2	40°	20°	2,0	▲
DSKMA.100.070	1,0	0,50	2,50	7,0	0,95	4	50	2	40°	20°	2,0	▲
DSKMA.120.030	1,2	0,60	3,00	3,6	1,15	4	50	2	20°	-°	0	▲
DSKMA.120.050	1,2	0,60	3,00	6,0	1,15	4	50	2	40°	20°	2,0	▲
DSKMA.120.070	1,2	0,60	3,00	8,4	1,15	4	50	2	40°	20°	2,0	▲
DSKMA.150.030	1,5	0,75	3,75	4,5	1,45	4	50	2	20°	-°	0	▲
DSKMA.150.050	1,5	0,75	3,75	7,5	1,45	4	50	2	40°	20°	2,5	▲
DSKMA.150.070	1,5	0,75	3,75	10,5	1,45	4	50	2	40°	20°	2,5	▲
DSKMA.200.030	2,0	1,00	5,00	6,0	1,90	4	50	2	20°	-°	0	▲
DSKMA.200.050	2,0	1,00	5,00	10,0	1,90	4	50	2	40°	20°	3,0	▲
DSKMA.200.070	2,0	1,00	5,00	14,0	1,90	4	50	2	40°	20°	3,0	▲
DSKMA.250.030	2,5	1,25	6,25	7,5	2,40	4	50	2	20°	-°	0	▲
DSKMA.250.050	2,5	1,25	6,25	12,5	2,40	4	50	2	40°	20°	3,5	▲
DSKMA.250.070	2,5	1,25	6,25	17,5	2,40	4	50	2	40°	20°	3,5	▲
DSKMA.300.030	3,0	1,50	7,50	9,0	2,90	4	50	2	20°	-°	0	▲
DSKMA.300.050	3,0	1,50	7,50	15,0	2,90	4	50	2	40°	20°	3,5	▲
DSKMA.300.070	3,0	1,50	7,50	21,0	2,90	4	64	2	40°	20°	3,5	▲

▲ ab Lager / on stock Δ 4 Wochen / 4 weeks x auf Anfrage / upon request

● empfohlen / recommended

o bedingt einsetzbar / alternative recommendation

- nicht geeignet / not suitable

■ unbeschichtete HM-Sorten / uncoated grades

■ beschichtete HM-Sorten / coated grades

■ bestückt/Cermet / brazed/Cermet

Abmessungen in mm

Dimensions in mm

P	-
M	-
K	-
N	•
S	-
H	-



HM-Sorten
Carbide grades

Schnittdaten DSKMA Ø 1,0 - 3,0 mm

Cutting Data DSKMA Ø 1,0 - 3,0 mm

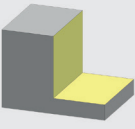
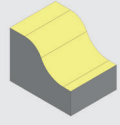

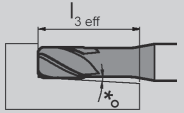
	 vc = m/min	 vc = m/min
N1.1	460	550
N1.2	480	580
N2.1	460	550
N2.2	390	470
N2.3	260	310
N3.1	330	400
N3.2	290	350
N4.1	330	400

d ₁												
		0°	0,5°	1°	2°	3°	f _z	a _e	a _p	f _z	a _e	a _p
1,0	7°	3,0	3,1	3,2	3,6	4,0	0,014	0,30	1,00	0,019	0,05	0,10
1,0	5°	5,0	5,1	5,2	5,4	5,7	0,012	0,30	1,00	0,017	0,05	0,08
1,0	3°	7,0	7,1	7,3	7,6	8,1	0,011	0,30	1,00	0,015	0,05	0,06
1,2	7°	3,6	3,7	3,9	4,3	4,8	0,016	0,36	1,20	0,022	0,06	0,12
1,2	5°	6,0	6,1	6,2	6,5	6,9	0,014	0,36	1,20	0,020	0,06	0,10
1,2	3°	8,4	8,5	8,7	9,2	9,8	0,013	0,36	1,20	0,018	0,06	0,07
1,5	7°	4,5	4,7	4,9	5,4	6,1	0,019	0,45	1,50	0,027	0,08	0,15
1,5	5°	7,5	7,6	7,8	8,2	8,6	0,017	0,45	1,50	0,024	0,08	0,12
1,5	3°	10,5	10,7	10,9	11,5	12,3	0,015	0,45	1,50	0,021	0,08	0,09
2,0	7°	6,0	6,2	6,5	7,2	8,1	0,024	0,60	2,00	0,034	0,10	0,20
2,0	5°	10,0	10,2	10,4	10,9	11,5	0,021	0,60	2,00	0,031	0,10	0,16
2,0	3°	14,0	14,3	14,6	15,3	17,2	0,019	0,60	2,00	0,027	0,10	0,12
2,5	7°	7,5	7,8	8,1	9,0	10,1	0,029	0,75	2,50	0,041	0,13	0,25
2,5	5°	12,5	12,7	13,0	13,7	∞	0,026	0,75	2,50	0,037	0,13	0,20
2,5	3°	17,5	17,9	18,3	19,5	∞	0,023	0,75	2,50	0,033	0,13	0,15
3,0	7°	9,0	9,3	9,8	10,8	∞	0,034	0,90	3,00	0,049	0,15	0,30
3,0	5°	15,0	15,3	15,6	∞	∞	0,031	0,90	3,00	0,044	0,15	0,24
3,0	3°	21,0	21,4	22,1	∞	∞	0,027	0,90	3,00	0,039	0,15	0,18

Abmessungen in mm
Dimensions in mm



Mikrofräser Torus, scharfkantig

Micro End Mill Torus, sharp



DSMA

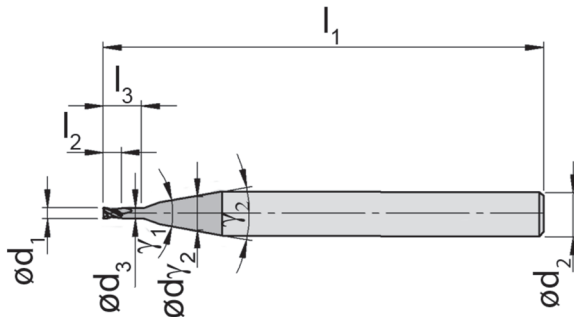
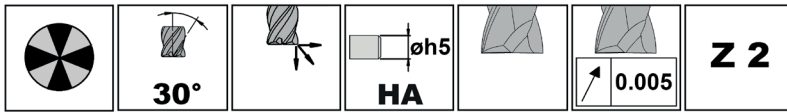

B

Bestellnummer Part number	d ₁	l ₂	l ₃	d ₃	d ₂	l ₁	Z	γ1	γ2	d _{v2}	MG3K
DSMA.010.030	0,1	0,25	0,3	0,084	4	50	2	20°	-°	0	▲
DSMA.010.050	0,1	0,25	0,5	0,084	4	50	2	40°	20°	2	▲
DSMA.010.070	0,1	0,25	0,7	0,084	4	50	2	40°	20°	2	▲
DSMA.020.030	0,2	0,50	0,6	0,180	4	50	2	20°	-°	0	▲
DSMA.020.050	0,2	0,50	1,0	0,180	4	50	2	40°	20°	2	▲
DSMA.020.070	0,2	0,50	1,4	0,180	4	50	2	40°	20°	2	▲
DSMA.030.030	0,3	0,75	0,9	0,280	4	50	2	20°	-°	0	▲
DSMA.030.050	0,3	0,75	1,5	0,280	4	50	2	40°	20°	2	▲
DSMA.030.070	0,3	0,75	2,1	0,280	4	50	2	40°	20°	2	▲
DSMA.050.030	0,5	1,25	1,5	0,470	4	50	2	20°	-°	0	▲
DSMA.050.050	0,5	1,25	2,5	0,470	4	50	2	40°	20°	2	▲
DSMA.050.070	0,5	1,25	3,5	0,470	4	50	2	40°	20°	2	▲
DSMA.060.030	0,6	1,50	1,8	0,560	4	50	2	20°	-°	0	▲
DSMA.060.050	0,6	1,50	3,0	0,560	4	50	2	40°	20°	2	▲
DSMA.060.070	0,6	1,50	4,2	0,560	4	50	2	40°	20°	2	▲
DSMA.080.030	0,8	2,00	2,4	0,750	4	50	2	20°	-°	0	▲
DSMA.080.050	0,8	2,00	4,0	0,750	4	50	2	40°	20°	2	▲
DSMA.080.070	0,8	2,00	5,6	0,750	4	50	2	40°	20°	2	▲
DSMA.100.030	1,0	2,50	3,0	0,950	4	50	2	20°	-°	0	▲
DSMA.100.050	1,0	2,50	5,0	0,950	4	50	2	40°	20°	2	▲
DSMA.100.070	1,0	2,50	7,0	0,950	4	50	2	40°	20°	2	▲

▲ ab Lager / on stock Δ 4 Wochen / 4 weeks x auf Anfrage / upon request

● empfohlen / recommended

o bedingt einsetzbar / alternative recommendation

- nicht geeignet / not suitable

■ unbeschichtete HM-Sorten / uncoated grades

■ beschichtete HM-Sorten / coated grades

■ bestückt/Cermet / brazed/Cermet

Abmessungen in mm

Dimensions in mm

P	-
M	-
K	-
N	•
S	-
H	-



HM-Sorten
Carbide grades

Schnittdaten DSMA Ø 0,1 - 1,0 mm

Cutting Data DSMA Ø 0,1 - 4,0 mm

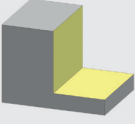
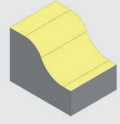

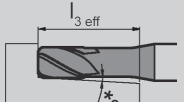
	 vc = m/min	 vc = m/min
N1.1	460	550
N1.2	480	580
N2.1	460	550
N2.2	390	470
N2.3	260	310
N3.1	330	400
N3.2	290	350
N4.1	330	400

d ₁	 α	 l _{3 eff}										
		0°	0,5°	1°	2°	3°	f _z	a _e	a _p	f _z	a _e	a _p
0,1	7°	0,3	0,3	0,3	0,3	0,4	0,005	0,03	0,10	0,006	0,01	0,01
0,1	5°	0,5	0,5	0,5	0,5	0,5	0,004	0,03	0,10	0,005	0,01	0,01
0,1	3°	0,7	0,7	0,7	0,7	0,8	0,004	0,03	0,10	0,005	0,01	0,01
0,2	7°	0,6	0,6	0,6	0,7	0,8	0,006	0,06	0,20	0,007	0,01	0,02
0,2	5°	1,0	1,0	1,0	1,1	1,1	0,005	0,06	0,20	0,006	0,01	0,02
0,2	3°	1,4	1,4	1,4	1,5	1,6	0,004	0,06	0,20	0,006	0,01	0,01
0,3	7°	0,9	0,9	1,0	1,2	1,2	0,007	0,09	0,30	0,009	0,02	0,03
0,3	5°	1,5	1,5	1,5	1,6	1,7	0,006	0,09	0,30	0,008	0,02	0,02
0,3	3°	2,1	2,1	2,2	2,3	2,4	0,005	0,09	0,30	0,007	0,02	0,02
0,5	7°	1,5	1,5	1,6	1,8	2,1	0,009	0,15	0,50	0,012	0,03	0,05
0,5	5°	2,5	2,5	2,6	2,7	2,9	0,008	0,15	0,50	0,011	0,03	0,04
0,5	3°	3,5	3,5	3,6	3,8	4,0	0,007	0,15	0,50	0,009	0,03	0,03
0,6	7°	1,8	1,8	2,0	2,2	2,5	0,010	0,18	0,60	0,013	0,03	0,06
0,6	5°	3,0	3,0	3,1	3,3	3,5	0,009	0,18	0,60	0,012	0,03	0,05
0,6	3°	4,2	4,3	4,4	4,6	4,9	0,008	0,18	0,60	0,011	0,03	0,04
0,8	7°	2,4	2,5	2,6	2,9	3,4	0,012	0,24	0,80	0,016	0,04	0,08
0,8	5°	4,0	4,1	4,2	4,4	4,6	0,010	0,24	0,80	0,015	0,04	0,06
0,8	3°	5,6	5,7	5,8	6,1	6,5	0,009	0,24	0,80	0,013	0,04	0,05
1,0	7°	3,0	3,1	3,3	3,7	4,2	0,014	0,30	1,00	0,019	0,05	0,10
1,0	5°	5,0	5,1	5,2	5,5	5,8	0,012	0,30	1,00	0,017	0,05	0,08
1,0	3°	7,0	7,1	7,3	7,7	8,1	0,011	0,30	1,00	0,015	0,05	0,06

Abmessungen in mm
Dimensions in mm



Mikrofräser Torus, scharfkantig

Micro End Mill Torus, sharp



DSMA

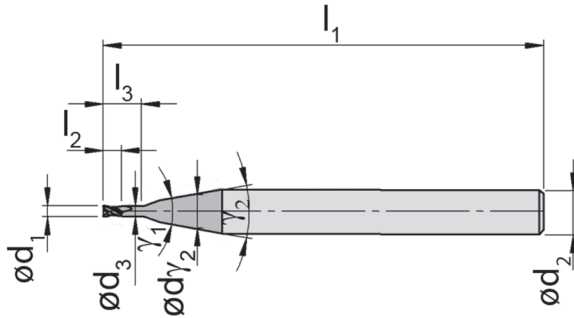

Bis Ø 3 mm vormontiert lieferbar für Toodle Schnelllaufspindel
Pre-assembled available up to Ø 3 mm for Toodle high-speed spindle

B

Bestellnummer Part number	d ₁	l ₂	l ₃	d ₃	d ₂	l ₁	Z	γ ₁	γ ₂	d _{v2}	MG3K
DSMA.120.030	1,2	3,00	3,6	1,15	4	50	2	20°	-°	0	▲
DSMA.120.050	1,2	3,00	6,0	1,15	4	50	2	40°	20°	2,0	▲
DSMA.120.070	1,2	3,00	8,4	1,15	4	50	2	40°	20°	2,0	▲
DSMA.150.030	1,5	3,75	4,5	1,45	4	50	2	20°	-°	0	▲
DSMA.150.050	1,5	3,75	7,5	1,45	4	50	2	40°	20°	2,5	▲
DSMA.150.070	1,5	3,75	10,5	1,45	4	50	2	40°	20°	2,5	▲
DSMA.200.030	2,0	5,00	6,0	1,90	4	50	2	20°	-°	0	▲
DSMA.200.050	2,0	5,00	10,0	1,90	4	50	2	40°	20°	3,0	▲
DSMA.200.070	2,0	5,00	14,0	1,90	4	50	2	40°	20°	3,0	▲
DSMA.250.030	2,5	6,25	7,5	2,40	4	50	2	20°	-°	0	▲
DSMA.250.050	2,5	6,25	12,5	2,40	4	50	2	40°	20°	3,5	▲
DSMA.250.070	2,5	6,25	17,5	2,40	4	50	2	40°	20°	3,5	▲
DSMA.300.030	3,0	7,50	9,0	2,90	4	50	2	20°	-°	0	▲
DSMA.300.050	3,0	7,50	15,0	2,90	4	50	2	40°	20°	3,5	▲
DSMA.300.070	3,0	7,50	21,0	2,90	4	64	2	40°	20°	3,5	▲

▲ ab Lager / on stock Δ 4 Wochen / 4 weeks x auf Anfrage / upon request

● empfohlen / recommended

o bedingt einsetzbar / alternative recommendation

- nicht geeignet / not suitable

■ unbeschichtete HM-Sorten / uncoated grades

■ beschichtete HM-Sorten / coated grades

■ bestückt/Cermet / brazed/Cermet

Abmessungen in mm

Dimensions in mm

P	-
M	-
K	-
N	•
S	-
H	-



HM-Sorten
Carbide grades

Schnittdaten DSMA Ø 1,2 - 3,0 mm

Cutting Data DSMA Ø 1,2 - 3,0 mm

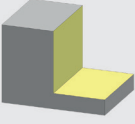
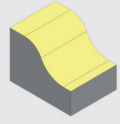

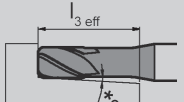
	 vc = m/min	 vc = m/min
N1.1	460	550
N1.2	480	580
N2.1	460	550
N2.2	390	470
N2.3	260	310
N3.1	330	400
N3.2	290	350
N4.1	330	400

d ₁	 α	 l _{3 eff}										
		0°	0,5°	1°	2°	3°	f _z	a _e	a _p	f _z	a _e	a _p
1,2	7°	3,6	3,7	3,9	4,4	5,1	0,016	0,36	1,20	0,022	0,06	0,12
1,2	5°	6,0	6,1	6,3	6,6	7,0	0,014	0,36	1,20	0,020	0,06	0,10
1,2	3°	8,4	8,6	8,8	9,2	10,0	0,013	0,36	1,20	0,018	0,06	0,07
1,5	7°	4,5	4,7	4,9	5,6	6,4	0,019	0,45	1,50	0,027	0,08	0,15
1,5	5°	7,5	7,6	7,8	8,2	8,7	0,017	0,45	1,50	0,024	0,08	0,12
1,5	3°	10,5	10,7	11,0	11,6	12,6	0,015	0,45	1,50	0,021	0,08	0,09
2,0	7°	6,0	6,3	6,6	7,4	8,5	0,024	0,60	2,00	0,034	0,10	0,20
2,0	5°	10,0	10,2	10,5	11,0	11,9	0,021	0,60	2,00	0,031	0,10	0,16
2,0	3°	14,0	14,3	14,7	15,4	17,6	0,019	0,60	2,00	0,027	0,10	0,12
2,5	7°	7,5	7,8	8,3	9,3	10,6	0,029	0,75	2,50	0,041	0,13	0,25
2,5	5°	12,5	12,8	13,1	13,8	∞	0,026	0,75	2,50	0,037	0,13	0,20
2,5	3°	17,5	17,9	18,3	19,8	∞	0,023	0,75	2,50	0,033	0,13	0,15
3,0	7°	9,0	9,4	9,9	11,2	∞	0,034	0,90	3,00	0,049	0,15	0,30
3,0	5°	15,0	15,3	15,7	∞	∞	0,031	0,90	3,00	0,044	0,15	0,24
3,0	3°	21,0	21,5	22,0	∞	∞	0,027	0,90	3,00	0,039	0,15	0,18

Abmessungen in mm
Dimensions in mm



DSTMA

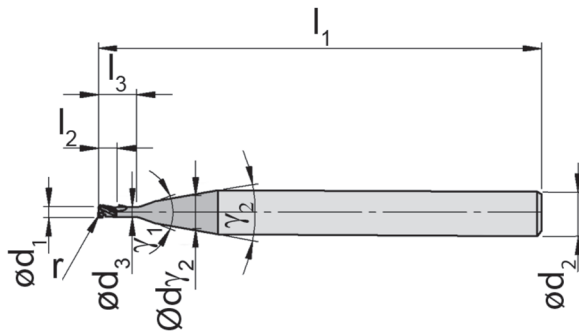
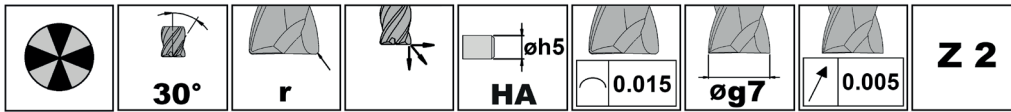

B

Bestellnummer Part number	d ₁	r	l ₂	l ₃	d ₃	d ₂	l ₁	Z	γ ₁	γ ₂	d _{v2}	MG3K
DSTMA.010.003.030	0,1	0,03	0,25	0,3	0,084	4	50	2	20°	-°	0	▲
DSTMA.010.003.050	0,1	0,03	0,25	0,5	0,084	4	50	2	40°	20°	2	▲
DSTMA.010.003.070	0,1	0,03	0,25	0,7	0,084	4	50	2	40°	20°	2	▲
DSTMA.020.005.030	0,2	0,05	0,50	0,6	0,180	4	50	2	20°	-°	0	▲
DSTMA.020.005.050	0,2	0,05	0,50	1,0	0,180	4	50	2	40°	20°	2	▲
DSTMA.020.005.070	0,2	0,05	0,50	1,4	0,180	4	50	2	40°	20°	2	▲
DSTMA.030.005.030	0,3	0,05	0,75	0,9	0,280	4	50	2	20°	-°	0	▲
DSTMA.030.005.050	0,3	0,05	0,75	1,5	0,280	4	50	2	40°	20°	2	▲
DSTMA.030.005.070	0,3	0,05	0,75	2,1	0,280	4	50	2	40°	20°	2	▲
DSTMA.050.005.030	0,5	0,05	1,25	1,5	0,470	4	50	2	20°	-°	0	▲
DSTMA.050.005.050	0,5	0,05	1,25	2,5	0,470	4	50	2	40°	20°	2	▲
DSTMA.050.005.070	0,5	0,05	1,25	3,5	0,470	4	50	2	40°	20°	2	▲
DSTMA.050.010.030	0,5	0,10	1,25	1,5	0,470	4	50	2	20°	-°	0	▲
DSTMA.050.010.050	0,5	0,10	1,25	2,5	0,470	4	50	2	40°	20°	2	▲
DSTMA.050.010.070	0,5	0,10	1,25	3,5	0,470	4	50	2	40°	20°	2	▲
DSTMA.060.005.030	0,6	0,05	1,50	1,8	0,560	4	50	2	20°	-°	0	▲
DSTMA.060.005.050	0,6	0,05	1,50	3,0	0,560	4	50	2	40°	20°	2	▲
DSTMA.060.005.070	0,6	0,05	1,50	4,2	0,560	4	50	2	40°	20°	2	▲
DSTMA.060.010.030	0,6	0,10	1,50	1,8	0,560	4	50	2	20°	-°	0	▲
DSTMA.060.010.050	0,6	0,10	1,50	3,0	0,560	4	50	2	40°	20°	2	▲
DSTMA.060.010.070	0,6	0,10	1,50	4,2	0,560	4	50	2	40°	20°	2	▲
DSTMA.080.005.030	0,8	0,05	2,00	2,4	0,750	4	50	2	20°	-°	0	▲
DSTMA.080.005.050	0,8	0,05	2,00	4,0	0,750	4	50	2	40°	20°	2	▲
DSTMA.080.005.070	0,8	0,05	2,00	5,6	0,750	4	50	2	40°	20°	2	▲
DSTMA.080.010.030	0,8	0,10	2,00	2,4	0,750	4	50	2	20°	-°	0	▲
DSTMA.080.010.050	0,8	0,10	2,00	4,0	0,750	4	50	2	40°	20°	2	▲
DSTMA.080.010.070	0,8	0,10	2,00	5,6	0,750	4	50	2	40°	20°	2	▲

▲ ab Lager / on stock Δ 4 Wochen / 4 weeks x auf Anfrage / upon request

● empfohlen / recommended

o bedingt einsetzbar / alternative recommendation

- nicht geeignet / not suitable

■ unbeschichtete HM-Sorten / uncoated grades

■ beschichtete HM-Sorten / coated grades

■ bestückt/Cermet / brazed/Cermet

Abmessungen in mm

Dimensions in mm

P	-
M	-
K	-
N	•
S	-
H	-



HM-Sorten
Carbide grades

Schnittdaten DSTMA Ø 0,1 - 0,8 mm

Cutting Data DSTMA Ø 0,1 - 0,8 mm

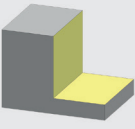
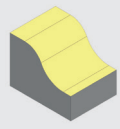

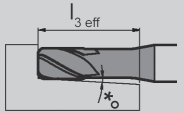
	 vc = m/min	 vc = m/min
N1.1	460	550
N1.2	480	580
N2.1	460	550
N2.2	390	470
N2.3	260	310
N3.1	330	400
N3.2	290	350
N4.1	330	400

d ₁												
		0°	0,5°	1°	2°	3°	f _z	a _e	a _p	f _z	a _e	a _p
0,1	7°	0,3	0,3	0,3	0,3	0,4	0,005	0,03	0,10	0,006	0,01	0,01
0,1	5°	0,5	0,5	0,5	0,5	0,5	0,004	0,03	0,10	0,005	0,01	0,01
0,1	3°	0,7	0,7	0,7	0,8	0,9	0,004	0,03	0,10	0,005	0,01	0,01
0,2	7°	0,6	0,6	0,6	0,7	0,8	0,006	0,06	0,20	0,007	0,01	0,02
0,2	5°	1,0	1,0	1,0	1,1	1,1	0,005	0,06	0,20	0,006	0,01	0,02
0,2	3°	1,4	1,4	1,4	1,5	1,6	0,004	0,06	0,20	0,006	0,01	0,01
0,3	7°	0,9	0,9	0,9	1,1	1,2	0,007	0,09	0,30	0,009	0,02	0,03
0,3	5°	1,5	1,5	1,5	1,6	1,7	0,006	0,09	0,30	0,008	0,02	0,02
0,3	3°	2,1	2,1	2,2	2,3	2,4	0,005	0,09	0,30	0,007	0,02	0,02
0,5	7°	1,5	1,5	1,6	1,8	2,1	0,009	0,15	0,50	0,012	0,03	0,05
0,5	5°	2,5	2,5	2,6	2,7	2,9	0,008	0,15	0,50	0,011	0,03	0,04
0,5	3°	3,5	3,5	3,6	3,8	4,0	0,007	0,15	0,50	0,009	0,03	0,03
0,5	7°	1,5	1,5	1,6	1,8	2,0	0,009	0,15	0,50	0,012	0,03	0,05
0,5	5°	2,5	2,5	2,6	2,7	2,9	0,008	0,15	0,50	0,011	0,03	0,04
0,5	3°	3,5	3,5	3,6	3,8	4,0	0,007	0,15	0,50	0,009	0,03	0,03
0,6	7°	1,8	1,8	1,9	2,2	2,5	0,010	0,18	0,60	0,013	0,03	0,06
0,6	5°	3,0	3,0	3,1	3,3	3,5	0,009	0,18	0,60	0,012	0,03	0,05
0,6	3°	4,2	4,2	4,4	4,6	4,9	0,008	0,18	0,60	0,011	0,03	0,04
0,6	7°	1,8	1,8	1,9	2,2	2,5	0,010	0,18	0,60	0,013	0,03	0,06
0,6	5°	3,0	3,0	3,1	3,3	3,4	0,009	0,18	0,60	0,012	0,03	0,05
0,6	3°	4,2	4,2	4,4	4,6	4,8	0,008	0,18	0,60	0,011	0,03	0,04
0,8	7°	2,4	2,5	2,6	2,9	3,3	0,012	0,24	0,80	0,016	0,04	0,08
0,8	5°	4,0	4,0	4,2	4,4	4,6	0,010	0,24	0,80	0,015	0,04	0,06
0,8	3°	5,6	5,7	5,8	6,1	6,5	0,009	0,24	0,80	0,013	0,04	0,05
0,8	7°	2,4	2,5	2,6	2,9	3,3	0,012	0,24	0,80	0,016	0,04	0,08
0,8	5°	4,0	4,0	4,2	4,4	4,6	0,010	0,24	0,80	0,015	0,04	0,06
0,8	3°	5,6	5,7	5,8	6,1	6,5	0,009	0,24	0,80	0,013	0,04	0,05

Abmessungen in mm
Dimensions in mm

B

DSTMA

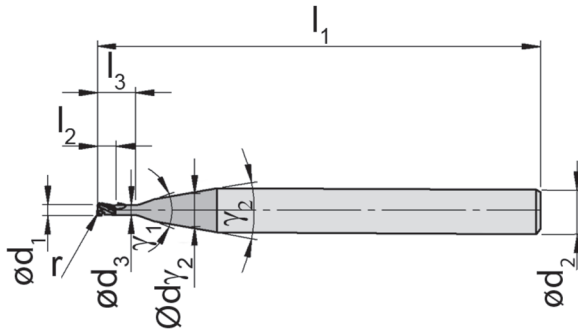
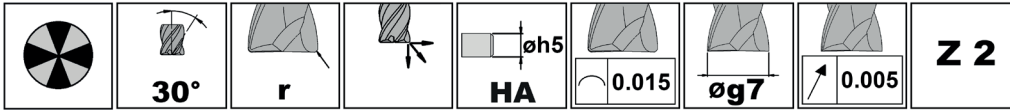

B

Bestellnummer Part number	d ₁	r	l ₂	l ₃	d ₃	d ₂	l ₁	Z	γ ₁	γ ₂	d _{γ₂}	MG3K
DSTMA.100.005.030	1,0	0,05	2,50	3,0	0,95	4	50	2	20°	-°	0	▲
DSTMA.100.005.050	1,0	0,05	2,50	5,0	0,95	4	50	2	40°	20°	2,0	▲
DSTMA.100.005.070	1,0	0,05	2,50	7,0	0,95	4	50	2	40°	20°	2,0	▲
DSTMA.100.010.030	1,0	0,10	2,50	3,0	0,95	4	50	2	20°	-°	0	▲
DSTMA.100.010.050	1,0	0,10	2,50	5,0	0,95	4	50	2	40°	20°	2,0	▲
DSTMA.100.010.070	1,0	0,10	2,50	7,0	0,95	4	50	2	40°	20°	2,0	▲
DSTMA.120.005.030	1,2	0,05	3,00	3,6	1,15	4	50	2	20°	-°	0	▲
DSTMA.120.005.050	1,2	0,05	3,00	6,0	1,15	4	50	2	40°	20°	2,0	▲
DSTMA.120.005.070	1,2	0,05	3,00	8,4	1,15	4	50	2	40°	20°	2,0	▲
DSTMA.120.010.030	1,2	0,10	3,00	3,6	1,15	4	50	2	20°	-°	0	▲
DSTMA.120.010.050	1,2	0,10	3,00	6,0	1,15	4	50	2	40°	20°	2,0	▲
DSTMA.120.010.070	1,2	0,10	3,00	8,4	1,15	4	50	2	40°	20°	2,0	▲
DSTMA.150.010.030	1,5	0,10	3,75	4,5	1,45	4	50	2	20°	-°	0	▲
DSTMA.150.010.050	1,5	0,10	3,75	7,5	1,45	4	50	2	40°	20°	2,5	▲
DSTMA.150.010.070	1,5	0,10	3,75	10,5	1,45	4	50	2	40°	20°	2,5	▲
DSTMA.150.020.030	1,5	0,20	3,75	4,5	1,45	4	50	2	20°	-°	0	▲
DSTMA.150.020.050	1,5	0,20	3,75	7,5	1,45	4	50	2	40°	20°	2,5	▲
DSTMA.150.020.070	1,5	0,20	3,75	10,5	1,45	4	50	2	40°	20°	2,5	▲
DSTMA.150.050.030	1,5	0,50	3,75	4,5	1,45	4	50	2	20°	-°	0	▲
DSTMA.150.050.050	1,5	0,50	3,75	7,5	1,45	4	50	2	40°	20°	2,5	▲
DSTMA.150.050.070	1,5	0,50	3,75	10,5	1,45	4	50	2	40°	20°	2,5	▲
DSTMA.200.010.030	2,0	0,10	5,00	6,0	1,90	4	50	2	20°	-°	0	▲
DSTMA.200.010.050	2,0	0,10	5,00	10,0	1,90	4	50	2	40°	20°	3,0	▲
DSTMA.200.010.070	2,0	0,10	5,00	14,0	1,90	4	50	2	40°	20°	3,0	▲
DSTMA.200.020.030	2,0	0,20	5,00	6,0	1,90	4	50	2	20°	-°	0	▲
DSTMA.200.020.050	2,0	0,20	5,00	10,0	1,90	4	50	2	40°	20°	3,0	▲
DSTMA.200.020.070	2,0	0,20	5,00	14,0	1,90	4	50	2	40°	20°	3,0	▲
DSTMA.200.050.030	2,0	0,50	5,00	6,0	1,90	4	50	2	20°	-°	0	▲
DSTMA.200.050.050	2,0	0,50	5,00	10,0	1,90	4	50	2	40°	20°	3,0	▲
DSTMA.200.050.070	2,0	0,50	5,00	14,0	1,90	4	50	2	40°	20°	3,0	▲

▲ ab Lager / on stock Δ 4 Wochen / 4 weeks x auf Anfrage / upon request

● empfohlen / recommended

o bedingt einsetzbar / alternative recommendation

- nicht geeignet / not suitable

■ unbeschichtete HM-Sorten / uncoated grades

■ beschichtete HM-Sorten / coated grades

■ bestückt/Cermet / brazed/Cermet

Abmessungen in mm



Dimensions in mm



P	-
M	-
K	-
N	•
S	-
H	-

Schnittdaten DSTMA Ø 1,0 - 2,0 mm

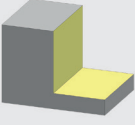
Cutting Data DSTMA Ø 1,0 - 2,0 mm

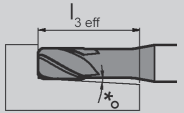

	 $vc = m/min$	 $vc = m/min$
N1.1	460	550
N1.2	480	580
N2.1	460	550
N2.2	390	470
N2.3	260	310
N3.1	330	400
N3.2	290	350
N4.1	330	400

d_1												
		0°	$0,5^\circ$	1°	2°	3°	f_z	a_e	a_p	f_z	a_e	a_p
1,0	7°	3,0	3,1	3,3	3,7	4,2	0,014	0,30	1,00	0,019	0,05	0,10
1,0	5°	5,0	5,1	5,2	5,5	5,8	0,012	0,30	1,00	0,017	0,05	0,08
1,0	3°	7,0	7,1	7,3	7,7	8,1	0,011	0,30	1,00	0,015	0,05	0,06
1,0	7°	3,0	3,1	3,3	3,7	4,2	0,014	0,30	1,00	0,019	0,05	0,10
1,0	5°	5,0	5,1	5,2	5,5	5,8	0,012	0,30	1,00	0,017	0,05	0,08
1,0	3°	7,0	7,1	7,3	7,7	8,1	0,011	0,30	1,00	0,015	0,05	0,06
1,2	7°	3,6	3,7	3,9	4,4	5,1	0,016	0,36	1,20	0,022	0,06	0,12
1,2	5°	6,0	6,1	6,3	6,6	7,0	0,014	0,36	1,20	0,020	0,06	0,10
1,2	3°	8,4	8,6	8,8	9,2	10,0	0,013	0,36	1,20	0,018	0,06	0,07
1,2	7°	3,6	3,7	3,9	4,4	5,0	0,016	0,36	1,20	0,022	0,06	0,12
1,2	5°	6,0	6,1	6,3	6,6	6,9	0,014	0,36	1,20	0,020	0,06	0,10
1,2	3°	8,4	8,6	8,8	9,2	10,0	0,013	0,36	1,20	0,018	0,06	0,07
1,5	7°	4,5	4,7	4,9	5,5	6,3	0,019	0,45	1,50	0,027	0,08	0,15
1,5	5°	7,5	7,6	7,8	8,2	8,7	0,017	0,45	1,50	0,024	0,08	0,12
1,5	3°	10,5	10,7	11,0	11,6	12,6	0,015	0,45	1,50	0,021	0,08	0,09
1,5	7°	4,5	4,7	4,9	5,5	6,3	0,019	0,45	1,50	0,027	0,08	0,15
1,5	5°	7,5	7,6	7,8	8,2	8,7	0,017	0,45	1,50	0,024	0,08	0,12
1,5	3°	10,5	10,7	11,0	11,5	12,5	0,015	0,45	1,50	0,021	0,08	0,09
1,5	7°	4,5	4,7	4,9	5,4	6,2	0,019	0,45	1,50	0,027	0,08	0,15
1,5	5°	7,5	7,6	7,8	8,2	8,6	0,017	0,45	1,50	0,024	0,08	0,12
1,5	3°	10,5	10,7	11,0	11,5	12,4	0,015	0,45	1,50	0,021	0,08	0,09
2,0	7°	6,0	6,3	6,6	7,4	8,5	0,024	0,60	2,00	0,034	0,10	0,20
2,0	5°	10,0	10,2	10,5	11,0	11,9	0,021	0,60	2,00	0,031	0,10	0,16
2,0	3°	14,0	14,3	14,7	15,4	17,6	0,019	0,60	2,00	0,027	0,10	0,12
2,0	7°	6,0	6,3	6,6	7,4	8,4	0,024	0,60	2,00	0,034	0,10	0,20
2,0	5°	10,0	10,2	10,4	11,0	11,8	0,021	0,60	2,00	0,031	0,10	0,16
2,0	3°	14,0	14,3	14,7	15,4	17,5	0,019	0,60	2,00	0,027	0,10	0,12
2,0	7°	6,0	6,2	6,6	7,3	8,3	0,024	0,60	2,00	0,034	0,10	0,20
2,0	5°	10,0	11,7	11,0	10,4	10,2	0,021	0,60	2,00	0,031	0,10	0,16
2,0	3°	14,0	14,3	14,6	15,4	17,4	0,019	0,60	2,00	0,027	0,10	0,12

Abmessungen in mm
Dimensions in mm

B

DSTMA

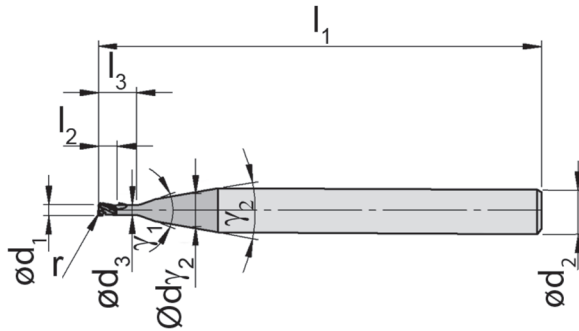
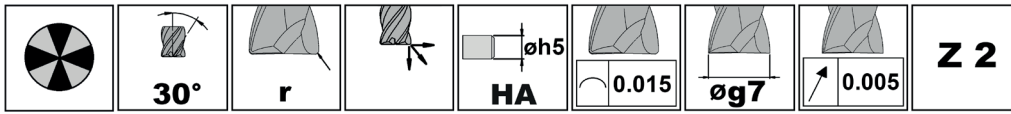

Bis Ø 3 mm vormontiert lieferbar für Toodle Schnelllaufspindel
Pre-assembled available up to Ø 3 mm for Toodle high-speed spindle

B

Bestellnummer Part number	d ₁	r	l ₂	l ₃	d ₃	d ₂	l ₁	Z	γ ₁	γ ₂	d _{γ₂}	MG3K
DSTMA.250.010.030	2,5	0,1	6,25	7,5	2,4	4	50	2	20°	-°	0	▲
DSTMA.250.010.050	2,5	0,1	6,25	12,5	2,4	4	50	2	40°	20°	3,5	▲
DSTMA.250.010.070	2,5	0,1	6,25	17,5	2,4	4	50	2	40°	20°	3,5	▲
DSTMA.250.020.030	2,5	0,2	6,25	7,5	2,4	4	50	2	20°	-°	0	▲
DSTMA.250.020.050	2,5	0,2	6,25	12,5	2,4	4	50	2	40°	20°	3,5	▲
DSTMA.250.020.070	2,5	0,2	6,25	17,5	2,4	4	50	2	40°	20°	3,5	▲
DSTMA.250.050.030	2,5	0,5	6,25	7,5	2,4	4	50	2	20°	-°	0	▲
DSTMA.250.050.050	2,5	0,5	6,25	12,5	2,4	4	50	2	40°	20°	3,5	▲
DSTMA.250.050.070	2,5	0,5	6,25	17,5	2,4	4	50	2	40°	20°	3,5	▲
DSTMA.300.010.030	3,0	0,1	7,50	9,0	2,9	4	50	2	20°	-°	0	▲
DSTMA.300.010.050	3,0	0,1	7,50	15,0	2,9	4	50	2	40°	20°	3,5	▲
DSTMA.300.010.070	3,0	0,1	7,50	21,0	2,9	4	64	2	40°	20°	3,5	▲
DSTMA.300.020.030	3,0	0,2	7,50	9,0	2,9	4	50	2	20°	-°	0	▲
DSTMA.300.020.050	3,0	0,2	7,50	15,0	2,9	4	50	2	40°	20°	3,5	▲
DSTMA.300.020.070	3,0	0,2	7,50	21,0	2,9	4	64	2	40°	20°	3,5	▲
DSTMA.300.050.030	3,0	0,5	7,50	9,0	2,9	4	50	2	20°	-°	0	▲
DSTMA.300.050.050	3,0	0,5	7,50	15,0	2,9	4	50	2	40°	20°	3,5	▲
DSTMA.300.050.070	3,0	0,5	7,50	21,0	2,9	4	64	2	40°	20°	3,5	▲
DSTMA.300.100.030	3,0	1,0	7,50	9,0	2,9	4	50	2	20°	-°	0	▲
DSTMA.300.100.050	3,0	1,0	7,50	15,0	2,9	4	50	2	40°	20°	3,5	▲
DSTMA.300.100.070	3,0	1,0	7,50	21,0	2,9	4	64	2	40°	20°	3,5	▲

▲ ab Lager / on stock Δ 4 Wochen / 4 weeks x auf Anfrage / upon request

● empfohlen / recommended

o bedingt einsetzbar / alternative recommendation

- nicht geeignet / not suitable

■ unbeschichtete HM-Sorten / uncoated grades

■ beschichtete HM-Sorten / coated grades

■ bestückt/Cermet / brazed/Cermet

Abmessungen in mm

Dimensions in mm

P	-
M	-
K	-
N	•
S	-
H	-



HM-Sorten
Carbide grades

Schnittdaten DSTMA Ø 2,5 - 3,0 mm

Cutting Data DSTMA Ø 2,5 - 3,0 mm

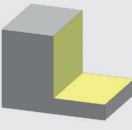
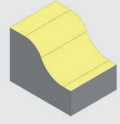

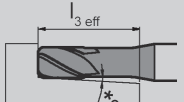
	 vc = m/min	 vc = m/min
N1.1	460	550
N1.2	480	580
N2.1	460	550
N2.2	390	470
N2.3	260	310
N3.1	330	400
N3.2	290	350
N4.1	330	400

d ₁	 α	 l _{3 eff}										
		0°	0,5°	1°	2°	3°	f _z	a _e	a _p	f _z	a _e	a _p
2,5	7°	7,5	7,8	8,3	9,3	10,6	0,029	0,75	2,50	0,041	0,13	0,25
2,5	5°	12,5	12,8	13,1	13,8	∞	0,026	0,75	2,50	0,037	0,13	0,20
2,5	3°	17,5	17,9	18,3	19,8	∞	0,023	0,75	2,50	0,033	0,13	0,15
2,5	7°	7,5	7,8	8,3	9,3	10,5	0,029	0,75	2,50	0,041	0,13	0,25
2,5	5°	12,5	12,8	13,1	13,8	∞	0,026	0,75	2,50	0,037	0,13	0,20
2,5	3°	17,5	17,9	18,3	19,7	∞	0,023	0,75	2,50	0,033	0,13	0,15
2,5	7°	7,5	7,8	8,2	9,2	10,4	0,029	0,75	2,50	0,041	0,13	0,25
2,5	5°	12,5	12,7	13,1	13,7	∞	0,026	0,75	2,50	0,037	0,13	0,20
2,5	3°	17,5	17,9	18,3	19,7	∞	0,023	0,75	2,50	0,033	0,13	0,15
3,0	7°	9,0	9,4	9,9	11,2	12,7	0,034	0,90	3,00	0,049	0,15	0,30
3,0	5°	15,0	15,3	15,7	∞	∞	0,031	0,90	3,00	0,044	0,15	0,24
3,0	3°	21,0	21,5	22,3	∞	∞	0,027	0,90	3,00	0,039	0,15	0,18
3,0	7°	9,0	9,4	9,9	11,1	∞	0,034	0,90	3,00	0,049	0,15	0,30
3,0	5°	15,0	15,3	15,7	∞	∞	0,031	0,90	3,00	0,044	0,15	0,24
3,0	3°	21,0	21,5	22,3	∞	∞	0,027	0,90	3,00	0,039	0,15	0,18
3,0	7°	9,0	9,4	9,9	11,1	∞	0,034	0,90	3,00	0,049	0,15	0,30
3,0	5°	15,0	15,3	15,7	∞	19,9	0,031	0,90	3,00	0,044	0,15	0,24
3,0	3°	21,0	21,5	22,2	∞	28,4	0,027	0,90	3,00	0,039	0,15	0,18
3,0	7°	9,0	9,4	9,8	10,9	∞	0,034	0,90	3,00	0,049	0,15	0,30
3,0	5°	15,0	15,3	15,7	∞	∞	0,031	0,90	3,00	0,044	0,15	0,24
3,0	3°	21,0	21,4	22,2	∞	∞	0,027	0,90	3,00	0,039	0,15	0,18

Abmessungen in mm
Dimensions in mm



Schaftfräser Einschneider

End Mill single fluted



DSA

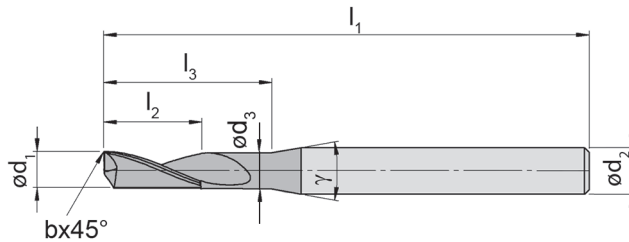
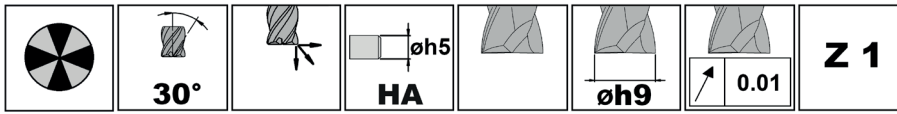

B

Bestellnummer Part number	d ₁	l ₂	l ₃	d ₃	d ₂	l ₁	Z	γ ₁	γ ₂	d _{v2}	MG3K
DSA.1.003.030	0,3	0,75	0,90	0,28	4	50	1	20°	-°	-	▲
DSA.1.003.050	0,3	1,05	1,50	0,28	4	50	1	40°	20°	2,0	▲
DSA.1.003.053	0,3	1,50	1,59	0,28	4	50	1	40°	20°	2,0	▲
DSA.1.004.030	0,4	1,00	1,20	0,38	4	50	1	20°	-°	-	▲
DSA.1.004.050	0,4	1,40	2,00	0,38	4	50	1	40°	20°	2,0	▲
DSA.1.004.053	0,4	2,00	2,12	0,38	4	50	1	40°	20°	2,0	▲
DSA.1.005.030	0,5	1,25	1,50	0,47	4	50	1	20°	-°	-	▲
DSA.1.005.050	0,5	1,75	2,50	0,47	4	50	1	40°	20°	2,0	▲
DSA.1.005.053	0,5	2,50	2,65	0,47	4	50	1	40°	20°	2,0	▲
DSA.1.006.030	0,6	1,50	1,80	0,56	4	50	1	20°	-°	-	▲
DSA.1.006.050	0,6	2,10	3,00	0,56	4	50	1	40°	20°	2,0	▲
DSA.1.006.053	0,6	3,00	3,18	0,56	4	50	1	40°	20°	2,0	▲
DSA.1.008.030	0,8	2,00	2,40	0,75	4	50	1	20°	-°	-	▲
DSA.1.008.050	0,8	2,80	4,00	0,75	4	50	1	40°	20°	2,0	▲
DSA.1.008.053	0,8	4,00	4,24	0,75	4	50	1	40°	20°	2,0	▲
DSA.1.010.030	1,0	2,50	3,00	0,95	4	50	1	20°	-°	-	▲
DSA.1.010.050	1,0	3,50	5,00	0,95	4	50	1	40°	20°	2,0	▲
DSA.1.010.053	1,0	5,00	5,30	0,95	4	50	1	40°	20°	2,0	▲
DSA.1.012.030	1,2	3,00	3,60	1,15	4	50	1	20°	-°	-	▲
DSA.1.012.050	1,2	4,20	6,00	1,15	4	50	1	40°	20°	2,0	▲
DSA.1.012.053	1,2	6,00	6,36	1,15	4	50	1	40°	20°	2,0	▲
DSA.1.015.030	1,5	3,75	4,50	1,45	4	50	1	20°	-°	-	▲
DSA.1.015.050	1,5	5,25	7,50	1,45	4	50	1	40°	20°	2,5	▲
DSA.1.015.053	1,5	7,50	7,95	1,45	4	50	1	40°	20°	2,5	▲
DSA.1.018.030	1,8	4,50	5,40	1,75	4	50	1	20°	-°	-	▲
DSA.1.018.050	1,8	6,30	9,00	1,75	4	50	1	40°	20°	3,0	▲
DSA.1.018.053	1,8	9,00	9,54	1,75	4	50	1	40°	20°	3,0	▲

▲ ab Lager / on stock Δ 4 Wochen / 4 weeks x auf Anfrage / upon request

● empfohlen / recommended

o bedingt einsetzbar / alternative recommendation

- nicht geeignet / not suitable

■ unbeschichtete HM-Sorten / uncoated grades

■ beschichtete HM-Sorten / coated grades

■ bestückt/Cermet / brazed/Cermet

Abmessungen in mm

Dimensions in mm

P	-
M	-
K	-
N	•
S	-
H	-



HM-Sorten
Carbide grades

Schnittdaten DSA Ø 0,3 - 1,8 mm

Cutting Data DSA Ø 0,3 - 1,8 mm

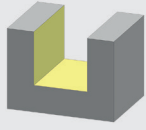
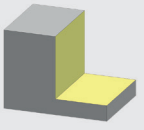

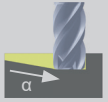
	 vc = m/min	 vc = m/min
N1.1	300	390
N1.2	320	420
N2.1	300	390
N2.2	250	330
N2.3	180	230
N3.1	200	260
N3.2	180	230
N4.1	200	260

d ₁							
		f _z	a _e	a _p	f _z	a _e	a _p
0,3	7°	0,022	0,30	0,45	0,045	0,08	0,75
0,3	5°	0,016	0,30	0,45	0,031	0,08	0,75
0,3	3°	0,016	0,30	0,45	0,031	0,08	1,50
0,4	7°	0,022	0,40	0,60	0,045	0,10	1,00
0,4	5°	0,016	0,40	0,60	0,031	0,10	1,00
0,4	3°	0,016	0,40	0,60	0,031	0,10	2,00
0,5	7°	0,023	0,50	0,75	0,045	0,13	1,25
0,5	5°	0,016	0,50	0,75	0,032	0,13	1,25
0,5	3°	0,016	0,50	0,75	0,032	0,13	2,50
0,6	7°	0,023	0,60	0,90	0,045	0,15	1,50
0,6	5°	0,016	0,60	0,90	0,032	0,15	1,50
0,6	3°	0,016	0,60	0,90	0,032	0,15	3,00
0,8	7°	0,023	0,80	1,20	0,046	0,20	2,00
0,8	5°	0,016	0,80	1,20	0,032	0,20	2,00
0,8	3°	0,016	0,80	1,20	0,032	0,20	4,00
1,0	7°	0,023	1,00	1,50	0,046	0,25	2,50
1,0	5°	0,016	1,00	1,50	0,032	0,25	2,50
1,0	3°	0,016	1,00	1,50	0,032	0,25	5,00
1,2	7°	0,023	1,20	1,80	0,047	0,30	3,00
1,2	5°	0,016	1,20	1,80	0,033	0,30	3,00
1,2	3°	0,016	1,20	1,80	0,033	0,30	6,00
1,5	7°	0,024	1,50	2,25	0,048	0,38	3,75
1,5	5°	0,017	1,50	2,25	0,033	0,38	3,75
1,5	3°	0,017	1,50	2,25	0,033	0,38	7,50
1,8	7°	0,024	1,80	2,70	0,048	0,45	4,50
1,8	5°	0,017	1,80	2,70	0,034	0,45	4,50
1,8	3°	0,017	1,80	2,70	0,034	0,45	9,00

Abmessungen in mm
Dimensions in mm



Schaftfräser Einschneider

End Mill single fluted



DSA

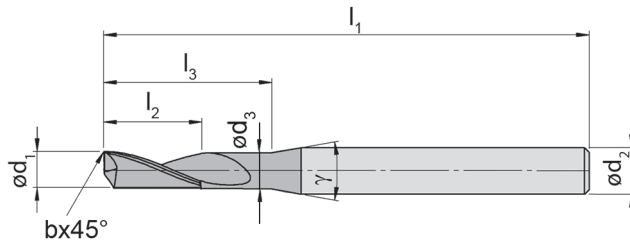
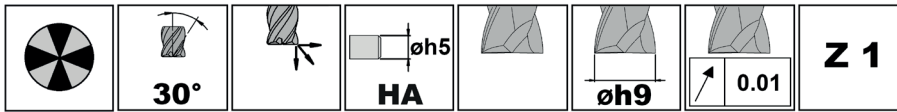

Bis Ø 3 mm vormontiert lieferbar für Toodle Schnellaufspindel
Pre-assembled available up to Ø 3 mm for Toodle high-speed spindle

Bestellnummer Part number	d ₁	b	l ₂	l ₃	d ₃	d ₂	l ₁	Z	γ ₁	γ ₂	d _{y2}	MG3K
DSA.1.020.030	2,0	-	5,00	6,00	1,9	4	50	1	20°	-°	-	▲
DSA.1.020.050	2,0	-	7,00	10,00	1,9	4	50	1	40°	20°	3,0	▲
DSA.1.020.053	2,0	-	10,00	10,60	1,9	4	50	1	40°	20°	3,0	▲
DSA.1.025.030	2,5	-	6,25	7,50	2,4	4	50	1	20°	-°	-	▲
DSA.1.025.050	2,5	-	8,75	12,50	2,4	4	50	1	40°	20°	3,5	▲
DSA.1.025.053	2,5	-	12,50	13,25	2,4	4	64	1	40°	20°	3,5	▲
DSA.1.030.030	3,0	0,1	7,50	9,00	2,9	4	50	1	20°	-°	-	▲
DSA.1.030.050	3,0	0,1	10,50	15,00	2,9	4	64	1	40°	20°	3,5	▲
DSA.1.030.053	3,0	0,1	15,00	15,90	2,9	4	64	1	40°	20°	3,5	▲
DSA.1.040.030	4,0	0,1	10,00	12,00	3,8	6	54	1	20°	-°	-	▲
DSA.1.040.050	4,0	0,1	14,00	20,00	3,8	6	64	1	20°	-°	-	▲
DSA.1.040.053	4,0	0,1	20,00	21,20	3,8	6	64	1	20°	-°	-	▲
DSA.1.050.030	5,0	0,1	12,50	15,00	4,7	6	64	1	20°	-°	-	▲
DSA.1.050.050	5,0	0,1	17,50	25,00	4,7	6	64	1	20°	-°	-	▲
DSA.1.050.053	5,0	0,1	25,00	26,50	4,7	6	64	1	20°	-°	-	▲
DSA.1.060.030	6,0	0,2	15,00	18,00	5,6	6	64	1	-°	-°	-	▲
DSA.1.060.050	6,0	0,2	21,00	30,00	5,6	6	82	1	-°	-°	-	▲
DSA.1.060.053	6,0	0,2	30,00	31,80	5,6	6	82	1	-°	-°	-	▲
DSA.1.080.030	8,0	0,2	20,00	24,00	7,5	8	64	1	-°	-°	-	▲
DSA.1.080.050	8,0	0,2	28,00	40,00	7,5	8	82	1	-°	-°	-	▲
DSA.1.080.053	8,0	0,2	40,00	42,40	7,5	8	82	1	-°	-°	-	▲
DSA.1.100.030	10,0	0,2	25,00	30,00	9,5	10	82	1	-°	-°	-	▲
DSA.1.100.050	10,0	0,2	35,00	50,00	9,5	10	108	1	-°	-°	-	▲
DSA.1.100.053	10,0	0,2	50,00	53,00	9,5	10	108	1	-°	-°	-	▲
DSA.1.120.030	12,0	0,2	30,00	36,00	11,5	12	82	1	-°	-°	-	▲
DSA.1.120.050	12,0	0,2	42,00	60,00	11,5	12	108	1	-°	-°	-	▲
DSA.1.120.053	12,0	0,2	60,00	63,60	11,5	12	108	1	-°	-°	-	▲

▲ ab Lager / on stock Δ 4 Wochen / 4 weeks x auf Anfrage / upon request

● empfohlen / recommended

o bedingt einsetzbar / alternative recommendation

- nicht geeignet / not suitable

■ unbeschichtete HM-Sorten / uncoated grades

■ beschichtete HM-Sorten / coated grades

■ bestückt/Cermet / brazed/Cermet

Abmessungen in mm

Dimensions in mm

P	-
M	-
K	-
N	•
S	-
H	-



HM-Sorten
Carbide grades

Schnittdaten DSA Ø 2,0 - 12,0 mm

Cutting Data DSA Ø 2,0 - 12,0 mm

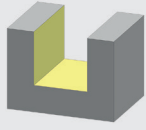
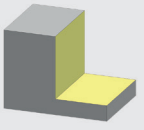

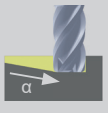
	 vc = m/min	 vc = m/min
N1.1	300	390
N1.2	320	420
N2.1	300	390
N2.2	250	330
N2.3	180	230
N3.1	200	260
N3.2	180	230
N4.1	200	260

d ₁	 α						
		f _z	a _e	a _p	f _z	a _e	a _p
2,0	7°	0,027	2,00	3,00	0,045	0,50	5,00
2,0	5°	0,019	2,00	3,00	0,031	0,50	5,00
2,0	3°	0,019	2,00	3,00	0,031	0,50	10,00
2,5	7°	0,032	2,50	3,75	0,052	0,63	6,25
2,5	5°	0,022	2,50	3,75	0,037	0,63	6,25
2,5	3°	0,022	2,50	3,75	0,037	0,63	12,50
3,0	7°	0,037	3,00	4,50	0,060	0,75	7,50
3,0	5°	0,026	3,00	4,50	0,042	0,75	7,50
3,0	3°	0,026	3,00	4,50	0,042	0,75	15,00
4,0	7°	0,047	4,00	6,00	0,075	1,00	10,00
4,0	5°	0,033	4,00	6,00	0,053	1,00	10,00
4,0	3°	0,033	4,00	6,00	0,053	1,00	20,00
5,0	7°	0,057	5,00	7,50	0,091	1,25	12,50
5,0	5°	0,040	5,00	7,50	0,063	1,25	12,50
5,0	3°	0,040	5,00	7,50	0,063	1,25	25,00
6,0	7°	0,067	6,00	9,00	0,106	1,50	15,00
6,0	5°	0,047	6,00	9,00	0,074	1,50	15,00
6,0	3°	0,047	6,00	9,00	0,074	1,50	30,00
8,0	7°	0,087	8,00	12,00	0,137	2,00	20,00
8,0	5°	0,061	8,00	12,00	0,096	2,00	20,00
8,0	3°	0,061	8,00	12,00	0,096	2,00	40,00
10,0	7°	0,107	10,00	15,00	0,168	2,50	25,00
10,0	5°	0,075	10,00	15,00	0,117	2,50	25,00
10,0	3°	0,075	10,00	15,00	0,117	2,50	50,00
12,0	7°	0,127	12,00	18,00	0,198	3,00	30,00
12,0	5°	0,089	12,00	18,00	0,139	3,00	30,00
12,0	3°	0,089	12,00	18,00	0,139	3,00	60,00

Abmessungen in mm
Dimensions in mm

B

Schaftfräser Vollradius

Ball Nose End Mill



DSKA

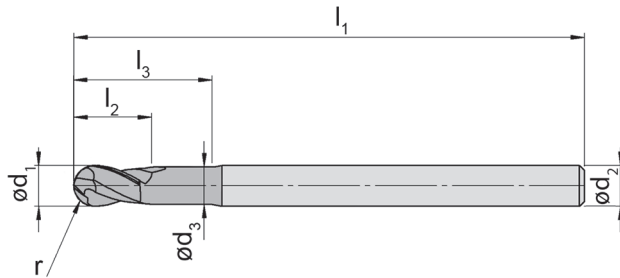
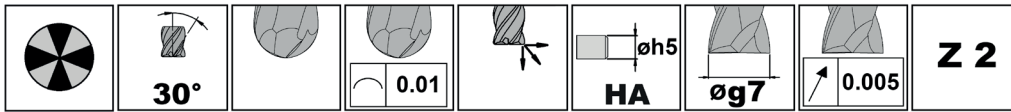

B

Bestellnummer Part number	d ₁	r	l ₂	l ₃	d ₃	d ₂	l ₁	Z	γ	MG3K
DSKA.2.040.030	4	2,0	10,0	12	3,8	6	64	2	20°	▲
DSKA.2.040.050	4	2,0	10,0	20	3,8	6	64	2	20°	▲
DSKA.2.040.070	4	2,0	10,0	28	3,8	6	70	2	20°	▲
DSKA.2.050.030	5	2,5	12,5	15	4,7	6	64	2	20°	▲
DSKA.2.050.050	5	2,5	12,5	25	4,7	6	64	2	20°	▲
DSKA.2.050.070	5	2,5	12,5	35	4,7	6	82	2	20°	▲
DSKA.2.060.030	6	3,0	15,0	18	5,6	6	64	2	-°	▲
DSKA.2.060.050	6	3,0	15,0	30	5,6	6	82	2	-°	▲
DSKA.2.060.070	6	3,0	15,0	42	5,6	6	82	2	-°	▲
DSKA.2.080.030	8	4,0	20,0	24	7,5	8	64	2	-°	▲
DSKA.2.080.050	8	4,0	20,0	40	7,5	8	82	2	-°	▲
DSKA.2.080.070	8	4,0	20,0	56	7,5	8	108	2	-°	▲
DSKA.2.100.030	10	5,0	25,0	30	9,5	10	82	2	-°	▲
DSKA.2.100.050	10	5,0	25,0	50	9,5	10	108	2	-°	▲
DSKA.2.100.070	10	5,0	25,0	70	9,5	10	120	2	-°	▲
DSKA.2.120.030	12	6,0	30,0	36	11,5	12	82	2	-°	▲
DSKA.2.120.050	12	6,0	30,0	60	11,5	12	108	2	-°	▲
DSKA.2.120.070	12	6,0	30,0	84	11,5	12	140	2	-°	▲
DSKA.2.160.030	16	8,0	40,0	48	15,0	16	108	2	-°	▲
DSKA.2.160.050	16	8,0	40,0	80	15,0	16	140	2	-°	▲
DSKA.2.200.030	20	10,0	50,0	60	19,0	20	120	2	-°	▲
DSKA.2.200.050	20	10,0	50,0	100	19,0	20	163	2	-°	▲

▲ ab Lager / on stock Δ 4 Wochen / 4 weeks x auf Anfrage / upon request

● empfohlen / recommended

o bedingt einsetzbar / alternative recommendation

- nicht geeignet / not suitable

■ unbeschichtete HM-Sorten / uncoated grades

■ beschichtete HM-Sorten / coated grades

■ bestückt/Cermet / brazed/Cermet

Abmessungen in mm

Dimensions in mm

P	-
M	-
K	-
N	•
S	-
H	-



HM-Sorten
Carbide grades

Schnittdaten DSKA Ø 4,0 - 20,0 mm

Cutting Data DSKA Ø 4,0 - 20,0 mm

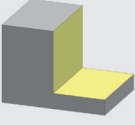
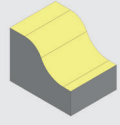

	 vc = m/min	 vc = m/min
N1.1	460	550
N1.2	480	580
N2.1	460	550
N2.2	390	470
N2.3	260	310
N3.1	330	400
N3.2	290	350
N4.1	330	400

d ₁							
		f _z	a _e	a _p	f _z	a _e	a _p
4	15°	0,044	1,20	4,00	0,037	0,12	0,40
4	10°	0,040	1,20	4,00	0,033	0,12	0,32
4	5°	0,035	1,20	4,00	0,030	0,12	0,24
5	15°	0,054	1,50	5,00	0,047	0,13	0,50
5	10°	0,049	1,50	5,00	0,042	0,13	0,40
5	5°	0,043	1,50	5,00	0,037	0,13	0,30
6	15°	0,064	1,80	6,00	0,056	0,14	0,60
6	10°	0,058	1,80	6,00	0,051	0,14	0,48
6	5°	0,052	1,80	6,00	0,045	0,14	0,36
8	15°	0,085	2,40	8,00	0,077	0,16	0,80
8	10°	0,076	2,40	8,00	0,069	0,16	0,64
8	5°	0,068	2,40	8,00	0,061	0,16	0,48
10	15°	0,105	3,00	10,00	0,097	0,18	1,00
10	10°	0,094	3,00	10,00	0,088	0,18	0,80
10	5°	0,084	3,00	10,00	0,078	0,18	0,60
12	15°	0,125	3,60	12,00	0,118	0,20	1,20
12	10°	0,113	3,60	12,00	0,107	0,20	0,96
12	5°	0,100	3,60	12,00	0,095	0,20	0,72
16	15°	0,166	4,80	16,00	0,161	0,24	1,60
16	10°	0,149	4,80	16,00	0,145	0,24	1,28
20	15°	0,206	6,00	20,00	0,204	0,28	2,00
20	10°	0,186	6,00	20,00	0,184	0,28	1,60

Abmessungen in mm
Dimensions in mm



Schlichtfräser, scharfkantig

Finishing End Mill sharp



DSA

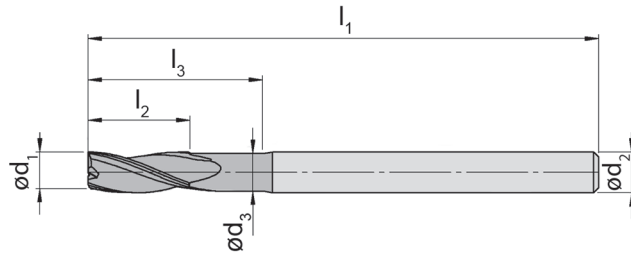
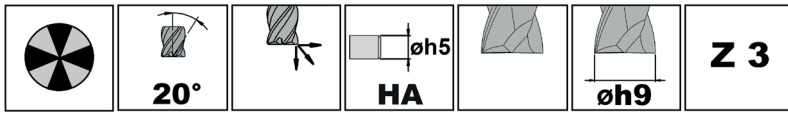

B

Bestellnummer Part number	d ₁	l ₂	l ₃	d ₃	d ₂	l ₁	Z	γ	MG3K
DSA.3.040.030	4	10,0	12,0	3,8	6	64	3	20°	▲
DSA.3.040.050	4	10,0	20,0	3,8	6	64	3	20°	▲
DSA.3.040.053	4	20,0	21,2	3,8	6	64	3	20°	▲
DSA.3.040.070	4	20,0	28,0	3,8	6	70	3	20°	▲
DSA.3.050.030	5	12,5	15,0	4,7	6	64	3	20°	▲
DSA.3.050.050	5	12,5	25,0	4,7	6	64	3	20°	▲
DSA.3.050.053	5	25,0	26,5	4,7	6	64	3	20°	▲
DSA.3.050.070	5	25,0	35,0	4,7	6	82	3	20°	▲
DSA.3.060.030	6	15,0	18,0	5,6	6	64	3	-°	▲
DSA.3.060.050	6	15,0	30,0	5,6	6	82	3	-°	▲
DSA.3.060.053	6	30,0	31,8	5,6	6	82	3	-°	▲
DSA.3.060.070	6	30,0	42,0	5,6	6	82	3	-°	▲
DSA.3.080.030	8	20,0	24,0	7,5	8	64	3	-°	▲
DSA.3.080.050	8	20,0	40,0	7,5	8	82	3	-°	▲
DSA.3.080.053	8	40,0	42,4	7,5	8	82	3	-°	▲
DSA.3.080.070	8	40,0	56,0	7,5	8	108	3	-°	▲
DSA.3.100.030	10	25,0	30,0	9,5	10	82	3	-°	▲
DSA.3.100.050	10	25,0	50,0	9,5	10	108	3	-°	▲
DSA.3.100.053	10	50,0	53,0	9,5	10	108	3	-°	▲
DSA.3.100.070	10	50,0	70,0	9,5	10	120	3	-°	▲
DSA.3.120.030	12	30,0	36,0	11,5	12	82	3	-°	▲
DSA.3.120.050	12	30,0	60,0	11,5	12	108	3	-°	▲
DSA.3.120.053	12	60,0	63,6	11,5	12	108	3	-°	▲
DSA.3.120.070	12	60,0	84,0	11,5	12	140	3	-°	▲
DSA.3.160.030	16	40,0	48,0	15,0	16	108	3	-°	▲
DSA.3.160.050	16	40,0	80,0	15,0	16	140	3	-°	▲
DSA.3.160.053	16	80,0	84,8	15,0	16	140	3	-°	▲
DSA.3.200.027	20	50,0	54,0	19,0	20	108	3	-°	▲
DSA.3.200.050	20	50,0	100,0	19,0	20	163	3	-°	▲
DSA.3.200.053	20	100,0	106,0	19,0	20	163	3	-°	▲

▲ ab Lager / on stock Δ 4 Wochen / 4 weeks x auf Anfrage / upon request

● empfohlen / recommended

○ bedingt einsetzbar / alternative recommendation

- nicht geeignet / not suitable

■ unbeschichtete HM-Sorten / uncoated grades

■ beschichtete HM-Sorten / coated grades

■ bestückt/Cermet / brazed/Cermet

Abmessungen in mm

Dimensions in mm

P	-
M	-
K	-
N	•
S	-
H	-



HM-Sorten
Carbide grades

Schnittdaten DSA Ø 4,0 - 20,0 mm

Cutting Data DSA Ø 4,0 - 20,0 mm

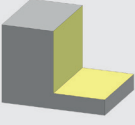
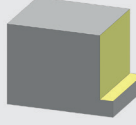

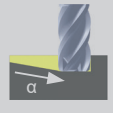
	 vc = m/min	 vc = m/min
N1.1	420	500
N1.2	440	530
N2.1	420	500
N2.2	350	420
N2.3	230	280
N3.1	290	350
N3.2	250	300
N4.1	290	350

d ₁							
		f _z	a _e	a _p	f _z	a _e	a _p
4	7°	0,020	1,00	10,00	0,018	0,20	10,00
4	5°	0,014	1,00	10,00	0,012	0,20	10,00
4	3°	0,014	1,00	20,00	0,012	0,20	20,00
4	3°	0,008	1,00	20,00	0,007	0,20	20,00
5	7°	0,028	1,25	12,50	0,027	0,25	12,50
5	5°	0,020	1,25	12,50	0,019	0,25	12,50
5	3°	0,020	1,25	25,00	0,019	0,25	25,00
5	3°	0,011	1,25	25,00	0,011	0,25	25,00
6	7°	0,036	1,50	15,00	0,036	0,30	15,00
6	5°	0,025	1,50	15,00	0,025	0,30	15,00
6	3°	0,025	1,50	30,00	0,025	0,30	30,00
6	3°	0,014	1,50	30,00	0,014	0,30	30,00
8	7°	0,052	2,00	20,00	0,053	0,40	20,00
8	5°	0,036	2,00	20,00	0,037	0,40	20,00
8	3°	0,036	2,00	40,00	0,037	0,40	40,00
8	3°	0,021	2,00	40,00	0,021	0,40	40,00
10	7°	0,068	2,50	25,00	0,071	0,50	25,00
10	5°	0,048	2,50	25,00	0,050	0,50	25,00
10	3°	0,048	2,50	50,00	0,050	0,50	50,00
10	3°	0,027	2,50	50,00	0,029	0,50	50,00
12	7°	0,084	3,00	30,00	0,089	0,60	30,00
12	5°	0,059	3,00	30,00	0,062	0,60	30,00
12	3°	0,059	3,00	60,00	0,062	0,60	60,00
12	3°	0,034	3,00	60,00	0,036	0,60	60,00
16	7°	0,116	4,00	40,00	0,125	0,80	40,00
16	5°	0,081	4,00	40,00	0,088	0,80	40,00
16	3°	0,081	4,00	80,00	0,088	0,80	80,00
20	7°	0,148	5,00	50,00	0,161	1,00	50,00
20	5°	0,104	5,00	50,00	0,113	1,00	50,00
20	3°	0,104	5,00	100,00	0,113	1,00	100,00

Abmessungen in mm

Dimensions in mm

B

Schaftfräser Mehrschneider, Radius

End Mill multiple fluted, radius



DSRA

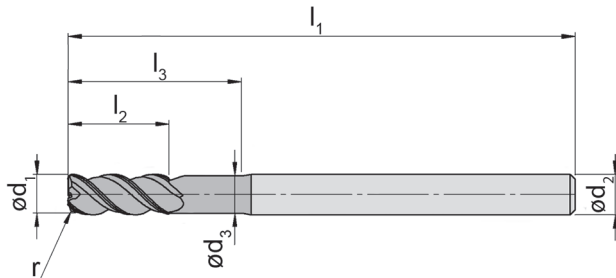
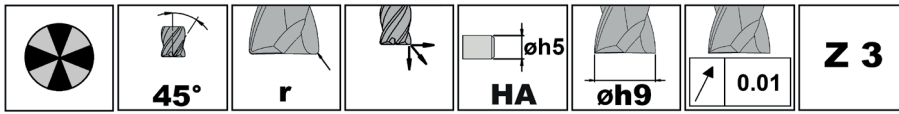

B

Bestellnummer Part number	d ₁	r	l ₂	l ₃	d ₃	d ₂	l ₁	Z	γ	MG3K
DSRA.3.040.010.030	4	0,1	10,0	12,0	3,8	6	64	3	20°	▲
DSRA.3.040.010.050	4	0,1	10,0	20,0	3,8	6	64	3	20°	▲
DSRA.3.040.010.053	4	0,1	20,0	21,2	3,8	6	64	3	20°	▲
DSRA.3.040.010.070	4	0,1	20,0	28,0	3,8	6	70	3	20°	▲
DSRA.3.040.050.030	4	0,5	10,0	12,0	3,8	6	64	3	20°	▲
DSRA.3.040.050.050	4	0,5	10,0	20,0	3,8	6	64	3	20°	▲
DSRA.3.040.050.053	4	0,5	20,0	21,2	3,8	6	64	3	20°	▲
DSRA.3.040.050.070	4	0,5	20,0	28,0	3,8	6	70	3	20°	▲
DSRA.3.040.100.030	4	1,0	10,0	12,0	3,8	6	64	3	20°	▲
DSRA.3.040.100.050	4	1,0	10,0	20,0	3,8	6	64	3	20°	▲
DSRA.3.040.100.053	4	1,0	20,0	21,2	3,8	6	64	3	20°	▲
DSRA.3.040.100.070	4	1,0	20,0	28,0	3,8	6	70	3	20°	▲
DSRA.3.050.010.030	5	0,1	12,5	15,0	4,7	6	64	3	20°	▲
DSRA.3.050.010.050	5	0,1	12,5	25,0	4,7	6	64	3	20°	▲
DSRA.3.050.010.053	5	0,1	25,0	26,5	4,7	6	64	3	20°	▲
DSRA.3.050.010.070	5	0,1	25,0	35,0	4,7	6	82	3	20°	▲
DSRA.3.050.050.030	5	0,5	12,5	15,0	4,7	6	64	3	20°	▲
DSRA.3.050.050.050	5	0,5	12,5	25,0	4,7	6	64	3	20°	▲
DSRA.3.050.050.053	5	0,5	25,0	26,5	4,7	6	64	3	20°	▲
DSRA.3.050.050.070	5	0,5	25,0	35,0	4,7	6	82	3	20°	▲
DSRA.3.050.100.030	5	1,0	12,5	15,0	4,7	6	64	3	20°	▲
DSRA.3.050.100.050	5	1,0	12,5	25,0	4,7	6	64	3	20°	▲
DSRA.3.050.100.053	5	1,0	25,0	26,5	4,7	6	64	3	20°	▲
DSRA.3.050.100.070	5	1,0	25,0	35,0	4,7	6	82	3	20°	▲

▲ ab Lager / on stock Δ 4 Wochen / 4 weeks x auf Anfrage / upon request

● empfohlen / recommended

o bedingt einsetzbar / alternative recommendation

- nicht geeignet / not suitable

■ unbeschichtete HM-Sorten / uncoated grades

■ beschichtete HM-Sorten / coated grades

■ bestückt/Cermet / brazed/Cermet

Abmessungen in mm

Dimensions in mm

P	-
M	-
K	-
N	•
S	-
H	-



HM-Sorten
Carbide grades

Schnittdaten DSRA Ø 4,0 - 5,0 mm

Cutting Data DSTMA Ø 4,0 - 5,0 mm

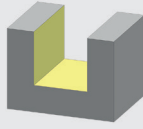
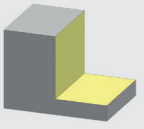

	 vc = m/min	 vc = m/min
N1.1	460	550
N1.2	480	580
N2.1	460	550
N2.2	390	470
N2.3	260	310
N3.1	330	400
N3.2	290	350
N4.1	330	400

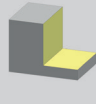
d ₁							
		f _z	a _e	a _p	f _z	a _e	a _p
4	7°	0,014	4,00	6,00	0,007	0,80	10,00
4	5°	0,010	4,00	6,00	0,005	0,80	10,00
4	3°	0,010	4,00	6,00	0,005	0,80	20,00
4	3°	0,006	4,00	6,00	0,003	0,80	20,00
4	7°	0,014	4,00	6,00	0,007	0,80	10,00
4	5°	0,010	4,00	6,00	0,005	0,80	10,00
4	3°	0,010	4,00	6,00	0,005	0,80	20,00
4	3°	0,006	4,00	6,00	0,003	0,80	20,00
4	7°	0,014	4,00	6,00	0,007	0,80	10,00
4	5°	0,010	4,00	6,00	0,005	0,80	10,00
4	3°	0,010	4,00	6,00	0,005	0,80	20,00
4	3°	0,006	4,00	6,00	0,003	0,80	20,00
5	7°	0,019	5,00	7,50	0,011	1,00	12,50
5	5°	0,013	5,00	7,50	0,008	1,00	12,50
5	3°	0,013	5,00	7,50	0,008	1,00	25,00
5	3°	0,008	5,00	7,50	0,004	1,00	25,00
5	7°	0,019	5,00	7,50	0,011	1,00	12,50
5	5°	0,013	5,00	7,50	0,008	1,00	12,50
5	3°	0,013	5,00	7,50	0,008	1,00	25,00
5	3°	0,008	5,00	7,50	0,004	1,00	25,00
5	7°	0,019	5,00	7,50	0,011	1,00	12,50
5	5°	0,013	5,00	7,50	0,008	1,00	12,50
5	3°	0,013	5,00	7,50	0,008	1,00	25,00
5	3°	0,008	5,00	7,50	0,004	1,00	25,00

Abmessungen in mm
Dimensions in mm



Schaftfräser Mehrschneider, Radius

End Mill multiple fluted, radius



DSRA

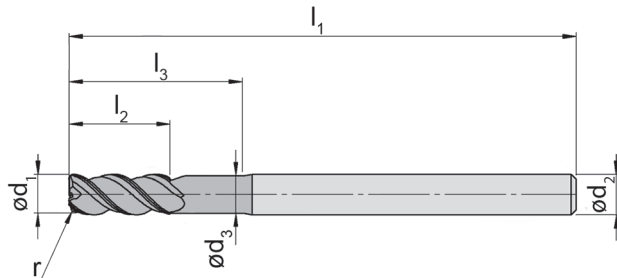
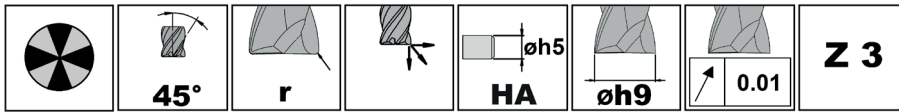

B

Bestellnummer Part number	d ₁	r	l ₂	l ₃	d ₃	d ₂	l ₁	Z	MG3K
DSRA.3.060.010.030	6	0,1	15	18,0	5,6	6	64	3	▲
DSRA.3.060.010.050	6	0,1	15	30,0	5,6	6	82	3	▲
DSRA.3.060.010.053	6	0,1	30	31,8	5,6	6	82	3	▲
DSRA.3.060.010.070	6	0,1	30	42,0	5,6	6	82	3	▲
DSRA.3.060.050.030	6	0,5	15	18,0	5,6	6	64	3	▲
DSRA.3.060.050.050	6	0,5	15	30,0	5,6	6	82	3	▲
DSRA.3.060.050.053	6	0,5	30	31,8	5,6	6	82	3	▲
DSRA.3.060.050.070	6	0,5	30	42,0	5,6	6	82	3	▲
DSRA.3.060.100.030	6	1,0	15	18,0	5,6	6	64	3	▲
DSRA.3.060.100.050	6	1,0	15	30,0	5,6	6	82	3	▲
DSRA.3.060.100.053	6	1,0	30	31,8	5,6	6	82	3	▲
DSRA.3.060.100.070	6	1,0	30	42,0	5,6	6	82	3	▲
DSRA.3.060.250.030	6	2,5	15	18,0	5,6	6	64	3	▲
DSRA.3.060.250.050	6	2,5	15	30,0	5,6	6	82	3	▲
DSRA.3.060.250.053	6	2,5	30	31,8	5,6	6	82	3	▲
DSRA.3.060.250.070	6	2,5	30	42,0	5,6	6	82	3	▲
DSRA.3.080.010.030	8	0,1	20	24,0	7,5	8	64	3	▲
DSRA.3.080.010.050	8	0,1	20	40,0	7,5	8	82	3	▲
DSRA.3.080.010.053	8	0,1	40	42,4	7,5	8	82	3	▲
DSRA.3.080.010.070	8	0,1	40	56,0	7,5	8	108	3	▲
DSRA.3.080.050.030	8	0,5	20	24,0	7,5	8	64	3	▲
DSRA.3.080.050.050	8	0,5	20	40,0	7,5	8	82	3	▲
DSRA.3.080.050.053	8	0,5	40	42,4	7,5	8	82	3	▲
DSRA.3.080.050.070	8	0,5	40	56,0	7,5	8	108	3	▲
DSRA.3.080.100.030	8	1,0	20	24,0	7,5	8	64	3	▲
DSRA.3.080.100.050	8	1,0	20	40,0	7,5	8	82	3	▲
DSRA.3.080.100.053	8	1,0	40	42,4	7,5	8	82	3	▲
DSRA.3.080.100.070	8	1,0	40	56,0	7,5	8	108	3	▲
DSRA.3.080.250.030	8	2,5	20	24,0	7,5	8	64	3	▲
DSRA.3.080.250.050	8	2,5	20	40,0	7,5	8	82	3	▲
DSRA.3.080.250.053	8	2,5	40	42,4	7,5	8	82	3	▲
DSRA.3.080.250.070	8	2,5	40	56,0	7,5	8	108	3	▲

▲ ab Lager / on stock Δ 4 Wochen / 4 weeks x auf Anfrage / upon request

● empfohlen / recommended

o bedingt einsetzbar / alternative recommendation

- nicht geeignet / not suitable

■ unbeschichtete HM-Sorten / uncoated grades

■ beschichtete HM-Sorten / coated grades

■ bestückt/Cermet / brazed/Cermet

Abmessungen in mm

Dimensions in mm



P	-
M	-
K	-
N	•
S	-
H	-

Schnittdaten DSRA Ø 6,0 - 8,0 mm

Cutting Data DSTMA Ø 6,0 - 8,0 mm

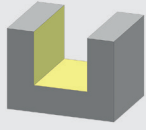
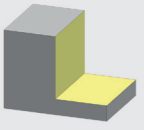

	 vc = m/min	 vc = m/min
N1.1	350	460
N1.2	370	480
N2.1	350	460
N2.2	300	390
N2.3	200	260
N3.1	250	330
N3.2	220	290
N4.1	250	330

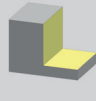
d ₁							
		f _z	a _e	a _p	f _z	a _e	a _p
6	7°	0,024	6,00	9,00	0,016	1,20	15,00
6	5°	0,017	6,00	9,00	0,011	1,20	15,00
6	3°	0,017	6,00	9,00	0,011	1,20	30,00
6	3°	0,010	6,00	9,00	0,006	1,20	30,00
6	7°	0,024	6,00	9,00	0,016	1,20	15,00
6	5°	0,017	6,00	9,00	0,011	1,20	15,00
6	3°	0,017	6,00	9,00	0,011	1,20	30,00
6	3°	0,010	6,00	9,00	0,006	1,20	30,00
6	7°	0,024	6,00	9,00	0,016	1,20	15,00
6	5°	0,017	6,00	9,00	0,011	1,20	15,00
6	3°	0,017	6,00	9,00	0,011	1,20	30,00
6	3°	0,010	6,00	9,00	0,006	1,20	30,00
6	7°	0,024	6,00	9,00	0,016	1,20	15,00
6	5°	0,017	6,00	9,00	0,011	1,20	15,00
6	3°	0,017	6,00	9,00	0,011	1,20	30,00
6	3°	0,010	6,00	9,00	0,006	1,20	30,00
6	7°	0,024	6,00	9,00	0,016	1,20	15,00
6	5°	0,017	6,00	9,00	0,011	1,20	15,00
6	3°	0,017	6,00	9,00	0,011	1,20	30,00
6	3°	0,010	6,00	9,00	0,006	1,20	30,00
8	7°	0,034	8,00	12,00	0,025	1,60	20,00
8	5°	0,024	8,00	12,00	0,017	1,60	20,00
8	3°	0,024	8,00	12,00	0,017	1,60	40,00
8	3°	0,014	8,00	12,00	0,010	1,60	40,00
8	7°	0,034	8,00	12,00	0,025	1,60	20,00
8	5°	0,024	8,00	12,00	0,017	1,60	20,00
8	3°	0,024	8,00	12,00	0,017	1,60	40,00
8	3°	0,014	8,00	12,00	0,010	1,60	40,00
8	7°	0,034	8,00	12,00	0,025	1,60	20,00
8	5°	0,024	8,00	12,00	0,017	1,60	20,00
8	3°	0,024	8,00	12,00	0,017	1,60	40,00
8	3°	0,014	8,00	12,00	0,010	1,60	40,00
8	7°	0,034	8,00	12,00	0,025	1,60	20,00
8	5°	0,024	8,00	12,00	0,017	1,60	20,00
8	3°	0,024	8,00	12,00	0,017	1,60	40,00
8	3°	0,014	8,00	12,00	0,010	1,60	40,00

Abmessungen in mm
Dimensions in mm

B

Schaftfräser Mehrschneider, Radius

End Mill multiple fluted, radius



DSRA

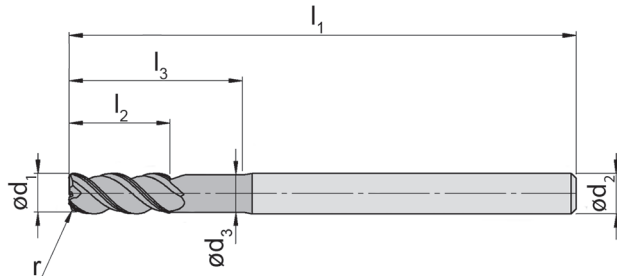
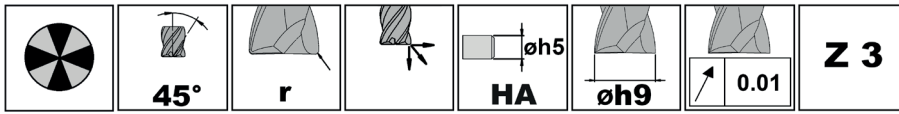

B

Bestellnummer Part number	d ₁	r	l ₂	l ₃	d ₃	d ₂	l ₁	Z	MG3K
DSRA.3.100.010.030	10	0,1	25	30,0	9,5	10	82	3	▲
DSRA.3.100.010.050	10	0,1	25	50,0	9,5	10	108	3	▲
DSRA.3.100.010.053	10	0,1	50	53,0	9,5	10	108	3	▲
DSRA.3.100.010.070	10	0,1	50	70,0	9,5	10	120	3	▲
DSRA.3.100.050.030	10	0,5	25	30,0	9,5	10	82	3	▲
DSRA.3.100.050.050	10	0,5	25	50,0	9,5	10	108	3	▲
DSRA.3.100.050.053	10	0,5	50	53,0	9,5	10	108	3	▲
DSRA.3.100.050.070	10	0,5	50	70,0	9,5	10	120	3	▲
DSRA.3.100.100.030	10	1,0	25	30,0	9,5	10	82	3	▲
DSRA.3.100.100.050	10	1,0	25	50,0	9,5	10	108	3	▲
DSRA.3.100.100.053	10	1,0	50	53,0	9,5	10	108	3	▲
DSRA.3.100.100.070	10	1,0	50	70,0	9,5	10	120	3	▲
DSRA.3.100.250.030	10	2,5	25	30,0	9,5	10	82	3	▲
DSRA.3.100.250.050	10	2,5	25	50,0	9,5	10	108	3	▲
DSRA.3.100.250.053	10	2,5	50	53,0	9,5	10	108	3	▲
DSRA.3.100.250.070	10	2,5	50	70,0	9,5	10	120	3	▲
DSRA.3.120.010.030	12	0,1	30	36,0	11,5	12	82	3	▲
DSRA.3.120.010.050	12	0,1	30	60,0	11,5	12	108	3	▲
DSRA.3.120.010.053	12	0,1	60	63,6	11,5	12	108	3	▲
DSRA.3.120.010.070	12	0,1	60	84,0	11,5	12	140	3	▲
DSRA.3.120.050.030	12	0,5	30	36,0	11,5	12	82	3	▲
DSRA.3.120.050.050	12	0,5	30	60,0	11,5	12	108	3	▲
DSRA.3.120.050.053	12	0,5	60	63,6	11,5	12	108	3	▲
DSRA.3.120.050.070	12	0,5	60	84,0	11,5	12	140	3	▲
DSRA.3.120.100.030	12	1,0	30	36,0	11,5	12	82	3	▲
DSRA.3.120.100.050	12	1,0	30	60,0	11,5	12	108	3	▲
DSRA.3.120.100.053	12	1,0	60	63,6	11,5	12	108	3	▲
DSRA.3.120.100.070	12	1,0	60	84,0	11,5	12	140	3	▲
DSRA.3.120.250.030	12	2,5	30	36,0	11,5	12	82	3	▲
DSRA.3.120.250.050	12	2,5	30	60,0	11,5	12	108	3	▲
DSRA.3.120.250.053	12	2,5	60	63,6	11,5	12	108	3	▲
DSRA.3.120.250.070	12	2,5	60	84,0	11,5	12	140	3	▲

▲ ab Lager / on stock Δ 4 Wochen / 4 weeks x auf Anfrage / upon request

● empfohlen / recommended

o bedingt einsetzbar / alternative recommendation

- nicht geeignet / not suitable

■ unbeschichtete HM-Sorten / uncoated grades

■ beschichtete HM-Sorten / coated grades

■ bestückt/Cermet / brazed/Cermet

Abmessungen in mm

Dimensions in mm

P	-
M	-
K	-
N	•
S	-
H	-



HM-Sorten
Carbide grades

Schnittdaten DSRA Ø 10,0 mm

Cutting Data DSTMA Ø 10,0 mm

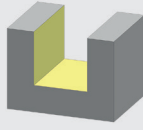
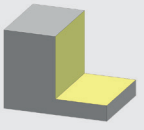

	 vc = m/min	 vc = m/min
N1.1	350	460
N1.2	370	480
N2.1	350	460
N2.2	300	390
N2.3	200	260
N3.1	250	330
N3.2	220	290
N4.1	250	330

d ₁							
		f _z	a _e	a _p	f _z	a _e	a _p
10	7°	0,044	10,00	15,00	0,033	2,00	25,00
10	5°	0,031	10,00	15,00	0,023	2,00	25,00
10	3°	0,031	10,00	15,00	0,023	2,00	50,00
10	3°	0,018	10,00	15,00	0,013	2,00	50,00
10	7°	0,044	10,00	15,00	0,033	2,00	25,00
10	5°	0,031	10,00	15,00	0,023	2,00	25,00
10	3°	0,031	10,00	15,00	0,023	2,00	50,00
10	3°	0,018	10,00	15,00	0,013	2,00	50,00
10	7°	0,044	10,00	15,00	0,033	2,00	25,00
10	5°	0,031	10,00	15,00	0,023	2,00	25,00
10	3°	0,031	10,00	15,00	0,023	2,00	50,00
10	3°	0,018	10,00	15,00	0,013	2,00	50,00
10	7°	0,044	10,00	15,00	0,033	2,00	25,00
10	5°	0,031	10,00	15,00	0,023	2,00	25,00
10	3°	0,031	10,00	15,00	0,023	2,00	50,00
10	3°	0,018	10,00	15,00	0,013	2,00	50,00
10	7°	0,044	10,00	15,00	0,033	2,00	25,00
10	5°	0,031	10,00	15,00	0,023	2,00	25,00
10	3°	0,031	10,00	15,00	0,023	2,00	50,00
10	3°	0,018	10,00	15,00	0,013	2,00	50,00
12	7°	0,054	12,00	18,00	0,042	2,40	30,00
12	5°	0,038	12,00	18,00	0,030	2,40	30,00
12	3°	0,038	12,00	18,00	0,030	2,40	60,00
12	3°	0,022	12,00	18,00	0,017	2,40	60,00
12	7°	0,054	12,00	18,00	0,042	2,40	30,00
12	5°	0,038	12,00	18,00	0,030	2,40	30,00
12	3°	0,038	12,00	18,00	0,030	2,40	60,00
12	3°	0,022	12,00	18,00	0,017	2,40	60,00
12	7°	0,054	12,00	18,00	0,042	2,40	30,00
12	5°	0,038	12,00	18,00	0,030	2,40	30,00
12	3°	0,038	12,00	18,00	0,030	2,40	60,00
12	3°	0,022	12,00	18,00	0,017	2,40	60,00
12	7°	0,054	12,00	18,00	0,042	2,40	30,00
12	5°	0,038	12,00	18,00	0,030	2,40	30,00
12	3°	0,038	12,00	18,00	0,030	2,40	60,00
12	3°	0,022	12,00	18,00	0,017	2,40	60,00

Abmessungen in mm
Dimensions in mm

B

Schaftfräser Mehrschneider, Radius

End Mill multiple fluted, radius



DSRA

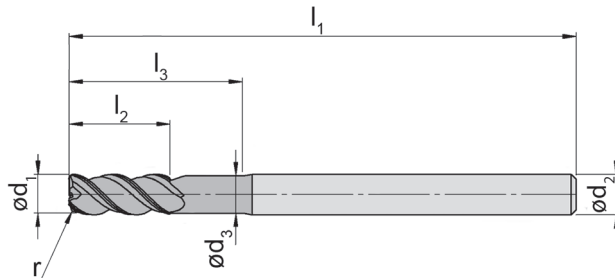
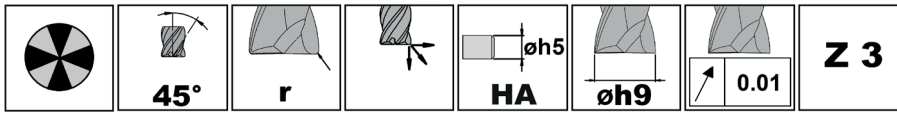

B

Bestellnummer Part number	d ₁	r	l ₂	l ₃	d ₃	d ₂	l ₁	Z	MG3K
DSRA.3.160.010.030	16	0,1	40	48,0	15	16	108	3	▲
DSRA.3.160.010.050	16	0,1	40	80,0	15	16	140	3	▲
DSRA.3.160.010.053	16	0,1	80	84,8	15	16	140	3	▲
DSRA.3.160.050.030	16	0,5	40	48,0	15	16	108	3	▲
DSRA.3.160.050.050	16	0,5	40	80,0	15	16	140	3	▲
DSRA.3.160.050.053	16	0,5	80	84,8	15	16	140	3	▲
DSRA.3.160.100.030	16	1,0	40	48,0	15	16	108	3	▲
DSRA.3.160.100.050	16	1,0	40	80,0	15	16	140	3	▲
DSRA.3.160.100.053	16	1,0	80	84,8	15	16	140	3	▲
DSRA.3.160.250.030	16	2,5	40	48,0	15	16	108	3	▲
DSRA.3.160.250.050	16	2,5	40	80,0	15	16	140	3	▲
DSRA.3.160.250.053	16	2,5	80	84,8	15	16	140	3	▲
DSRA.3.160.400.030	16	4,0	40	48,0	15	16	108	3	▲
DSRA.3.160.400.050	16	4,0	40	80,0	15	16	140	3	▲
DSRA.3.160.400.053	16	4,0	80	84,8	15	16	140	3	▲
DSRA.3.200.010.027	20	0,1	50	54,0	19	20	108	3	▲
DSRA.3.200.010.050	20	0,1	50	100,0	19	20	163	3	▲
DSRA.3.200.010.053	20	0,1	100	106,0	19	20	163	3	▲
DSRA.3.200.050.027	20	0,5	50	54,0	19	20	108	3	▲
DSRA.3.200.050.050	20	0,5	50	100,0	19	20	163	3	▲
DSRA.3.200.050.053	20	0,5	100	106,0	19	20	163	3	▲
DSRA.3.200.100.027	20	1,0	50	54,0	19	20	108	3	▲
DSRA.3.200.100.050	20	1,0	50	100,0	19	20	163	3	▲
DSRA.3.200.100.053	20	1,0	100	106,0	19	20	163	3	▲
DSRA.3.200.250.027	20	2,5	50	54,0	19	20	108	3	▲
DSRA.3.200.250.050	20	2,5	50	100,0	19	20	163	3	▲
DSRA.3.200.250.053	20	2,5	100	106,0	19	20	163	3	▲
DSRA.3.200.400.027	20	4,0	50	54,0	19	20	108	3	▲
DSRA.3.200.400.050	20	4,0	50	100,0	19	20	163	3	▲
DSRA.3.200.400.053	20	4,0	100	106,0	19	20	163	3	▲

▲ ab Lager / on stock Δ 4 Wochen / 4 weeks x auf Anfrage / upon request

● empfohlen / recommended

o bedingt einsetzbar / alternative recommendation

- nicht geeignet / not suitable

■ unbeschichtete HM-Sorten / uncoated grades

■ beschichtete HM-Sorten / coated grades

■ bestückt/Cermet / brazed/Cermet

Abmessungen in mm

Dimensions in mm

P	-
M	-
K	-
N	•
S	-
H	-



HM-Sorten
Carbide grades

Schnittdaten DSRA Ø 16,0 mm

Cutting Data DSTMA Ø 16,0 mm

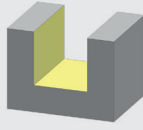
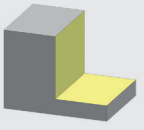

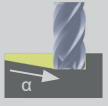
	 vc = m/min	 vc = m/min
N1.1	350	460
N1.2	370	480
N2.1	350	460
N2.2	300	390
N2.3	200	260
N3.1	250	330
N3.2	220	290
N4.1	250	330

d ₁							
		f _z	a _e	a _p	f _z	a _e	a _p
16	7°	0,074	16,00	24,00	0,060	3,20	40,00
16	5°	0,052	16,00	24,00	0,042	3,20	40,00
16	3°	0,052	16,00	24,00	0,042	3,20	80,00
16	3°	0,074	16,00	24,00	0,060	3,20	40,00
16	7°	0,052	16,00	24,00	0,042	3,20	40,00
16	5°	0,052	16,00	24,00	0,042	3,20	80,00
16	3°	0,074	16,00	24,00	0,060	3,20	40,00
16	3°	0,052	16,00	24,00	0,042	3,20	40,00
16	7°	0,052	16,00	24,00	0,042	3,20	80,00
16	5°	0,074	16,00	24,00	0,060	3,20	40,00
16	3°	0,052	16,00	24,00	0,042	3,20	40,00
16	3°	0,052	16,00	24,00	0,042	3,20	80,00
16	7°	0,074	16,00	24,00	0,060	3,20	40,00
16	5°	0,052	16,00	24,00	0,042	3,20	40,00
16	3°	0,052	16,00	24,00	0,042	3,20	80,00
20	3°	0,094	20,00	30,00	0,078	4,00	50,00
20	7°	0,066	20,00	30,00	0,055	4,00	50,00
20	5°	0,066	20,00	30,00	0,055	4,00	100,00
20	3°	0,094	20,00	30,00	0,078	4,00	50,00
20	3°	0,066	20,00	30,00	0,055	4,00	50,00
20	7°	0,066	20,00	30,00	0,055	4,00	100,00
20	5°	0,094	20,00	30,00	0,078	4,00	50,00
20	3°	0,066	20,00	30,00	0,055	4,00	50,00
20	3°	0,066	20,00	30,00	0,055	4,00	100,00
20	7°	0,094	20,00	30,00	0,078	4,00	50,00
20	5°	0,066	20,00	30,00	0,055	4,00	50,00
20	3°	0,066	20,00	30,00	0,055	4,00	100,00
20	3°	0,094	20,00	30,00	0,078	4,00	50,00
20	7°	0,066	20,00	30,00	0,055	4,00	50,00
20	5°	0,066	20,00	30,00	0,055	4,00	100,00

Abmessungen in mm
Dimensions in mm

B

Schaftfräser mit Eckfase

End Mill with corner chamfer



DSFA

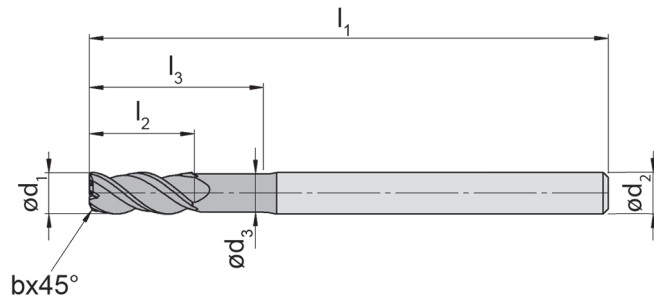
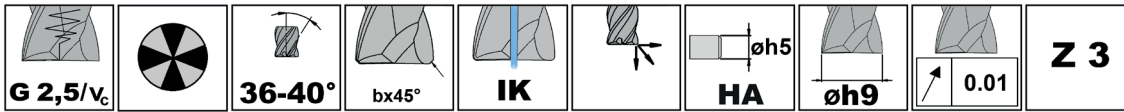

B

Bestellnummer Part number	d ₁	b	l ₂	l ₃	d ₃	d ₂	l ₁	Z	NE2K
DSFA.3.060.030	6	0,2	15	18,0	5,6	6	57	3	▲
DSFA.3.060.050	6	0,2	15	30,0	5,6	6	70	3	▲
DSFA.3.060.053	6	0,2	30	31,8	5,6	6	70	3	▲
DSFA.3.060.070	6	0,2	30	42,0	5,6	6	80	3	▲
DSFA.3.080.030	8	0,2	20	24,0	7,5	8	64	3	▲
DSFA.3.080.050	8	0,2	20	40,0	7,5	8	80	3	▲
DSFA.3.080.053	8	0,2	40	42,4	7,5	8	80	3	▲
DSFA.3.080.070	8	0,2	40	56,0	7,5	8	100	3	▲
DSFA.3.100.030	10	0,2	25	30,0	9,5	10	72	3	▲
DSFA.3.100.050	10	0,2	25	50,0	9,5	10	100	3	▲
DSFA.3.100.053	10	0,2	50	53,0	9,5	10	100	3	▲
DSFA.3.100.070	10	0,2	50	70,0	9,5	10	115	3	▲
DSFA.3.120.030	12	0,2	30	36,0	11,5	12	85	3	▲
DSFA.3.120.050	12	0,2	30	60,0	11,5	12	108	3	▲
DSFA.3.120.053	12	0,2	60	63,6	11,5	12	108	3	▲
DSFA.3.120.070	12	0,2	60	84,0	11,5	12	140	3	▲
DSFA.3.160.030	16	0,5	40	48,0	15,0	16	100	3	▲
DSFA.3.160.050	16	0,5	40	80,0	15,0	16	140	3	▲
DSFA.3.160.053	16	0,5	80	84,8	15,0	16	140	3	▲
DSFA.3.200.027	20	0,5	50	54,0	19,0	20	108	3	▲
DSFA.3.200.050	20	0,5	50	100,0	19,0	20	163	3	▲
DSFA.3.200.053	20	0,5	100	106,0	19,0	20	163	3	▲

▲ ab Lager / on stock Δ 4 Wochen / 4 weeks x auf Anfrage / upon request

● empfohlen / recommended

o bedingt einsetzbar / alternative recommendation

- nicht geeignet / not suitable

■ unbeschichtete HM-Sorten / uncoated grades

■ beschichtete HM-Sorten / coated grades

■ bestückt/Cermet / brazed/Cermet

Abmessungen in mm

Dimensions in mm

P	-
M	-
K	-
N	•
S	-
H	-



HM-Sorten
Carbide grades

Schnittdaten DSFA Ø 6,0 - 20,0 mm

Cutting Data DSFA Ø 6,0 - 20,0 mm

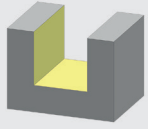
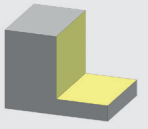

	 vc = m/min	 vc = m/min
N1.1	450	540
N1.2	500	600
N2.1	450	540
N2.2	350	420
N2.3	280	340
N3.1	300	360
N3.2	280	340
N4.1	300	360

d ₁							
		f _z	a _e	a _p	f _z	a _e	a _p
6	20°	0,026	6,00	9,00	0,047	1,20	15,00
6	10°	0,018	6,00	9,00	0,066	0,30	15,00
6	3°	0,018	6,00	9,00	0,066	0,30	30,00
6	3°	0,010	6,00	9,00	0,038	0,30	30,00
8	20°	0,035	8,00	12,00	0,128	0,40	20,00
8	10°	0,025	8,00	12,00	0,090	0,40	20,00
8	3°	0,025	8,00	12,00	0,090	0,40	40,00
8	3°	0,014	8,00	12,00	0,051	0,40	40,00
10	20°	0,044	10,00	15,00	0,161	0,50	25,00
10	10°	0,031	10,00	15,00	0,113	0,50	25,00
10	3°	0,031	10,00	15,00	0,113	0,50	50,00
10	3°	0,018	10,00	15,00	0,064	0,50	50,00
12	20°	0,054	12,00	18,00	0,194	0,60	30,00
12	10°	0,037	12,00	18,00	0,136	0,60	30,00
12	3°	0,037	12,00	18,00	0,136	0,60	60,00
12	3°	0,021	12,00	18,00	0,078	0,60	60,00
16	20°	0,072	16,00	24,00	0,260	0,80	40,00
16	10°	0,050	16,00	24,00	0,182	0,80	40,00
16	3°	0,050	16,00	24,00	0,182	0,80	80,00
20	20°	0,090	20,00	30,00	0,327	1,00	50,00
20	10°	0,063	20,00	30,00	0,229	1,00	50,00
20	3°	0,063	20,00	30,00	0,229	1,00	100,00

Abmessungen in mm
Dimensions in mm



Kordelschruppfräser

Roughing End Mill with ripper profile



DSFRA

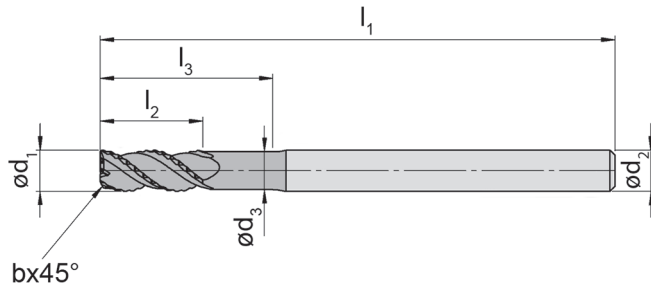
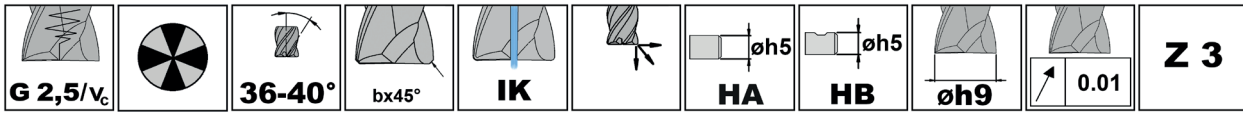

B

Bestellnummer Part number	d ₁	b	l ₂	l ₃	d ₃	d ₂	l ₁	Z	Ausführung Type	NEZK
DSFRA.3.060.030	6	0,4	15	18	5,6	6	57	3	HA	▲
DSFRA.3.060.050	6	0,4	15	30	5,6	6	70	3	HA	▲
DSFRA.3.080.030	8	0,5	20	24	7,5	8	64	3	HA	▲
DSFRA.3.080.050	8	0,5	20	40	7,5	8	80	3	HA	▲
DSFRA.3.100.030	10	0,5	25	30	9,5	10	72	3	HA	▲
DSFRA.3.100.050	10	0,5	25	50	9,5	10	100	3	HA	▲
DSFRA.3.120.030	12	0,5	30	36	11,5	12	85	3	HA	▲
DSFRA.3.120.030.B	12	0,5	30	36	11,5	12	85	3	HB	▲
DSFRA.3.120.050	12	0,5	30	60	11,5	12	108	3	HA	▲
DSFRA.3.120.050.B	12	0,5	30	60	11,5	12	108	3	HB	▲
DSFRA.3.160.030	16	0,6	40	48	15,0	16	100	3	HA	▲
DSFRA.3.160.030.B	16	0,6	40	48	15,0	16	100	3	HB	▲
DSFRA.3.160.050	16	0,6	40	80	15,0	16	140	3	HA	▲
DSFRA.3.160.050.B	16	0,6	40	80	15,0	16	140	3	HB	▲
DSFRA.3.200.027	20	0,8	50	54	18,8	20	108	3	HA	▲
DSFRA.3.200.027.B	20	0,8	50	54	18,8	20	108	3	HB	▲
DSFRA.3.200.050	20	0,8	50	100	18,8	20	163	3	HA	▲
DSFRA.3.200.050.B	20	0,8	50	100	18,8	20	163	3	HB	▲

▲ ab Lager / on stock Δ 4 Wochen / 4 weeks x auf Anfrage / upon request

● empfohlen / recommended

o bedingt einsetzbar / alternative recommendation

- nicht geeignet / not suitable

■ unbeschichtete HM-Sorten / uncoated grades

■ beschichtete HM-Sorten / coated grades

■ bestückt/Cermet / brazed/Cermet

Abmessungen in mm

Dimensions in mm

P	-
M	-
K	-
N	•
S	-
H	-



HM-Sorten
Carbide grades

Schnittdaten DSFRA Ø 6,0 - 20,0 mm

Cutting Data DSFRA Ø 6,0 - 20,0 mm

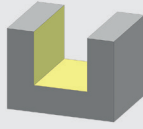
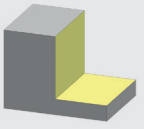

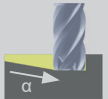
	 vc = m/min	 vc = m/min
N1.1	450	540
N1.2	500	600
N2.1	450	540
N2.2	350	420
N2.3	280	340
N3.1	300	360
N3.2	280	340
N4.1	300	360

d ₁							
		f _z	a _e	a _p	f _z	a _e	a _p
6	20°	0,030	6,00	9,00	0,062	2,40	15,00
6	10°	0,021	6,00	9,00	0,043	2,40	15,00
8	20°	0,041	8,00	12,00	0,083	3,20	20,00
8	10°	0,029	8,00	12,00	0,058	3,20	20,00
10	20°	0,053	10,00	15,00	0,104	4,00	25,00
10	10°	0,037	10,00	15,00	0,073	4,00	25,00
12	20°	0,064	12,00	18,00	0,125	4,80	30,00
12	20°	0,064	12,00	18,00	0,125	4,80	30,00
12	10°	0,045	12,00	18,00	0,087	4,80	30,00
12	10°	0,045	12,00	18,00	0,087	4,80	30,00
16	20°	0,086	16,00	24,00	0,167	6,40	40,00
16	20°	0,086	16,00	24,00	0,167	6,40	40,00
16	10°	0,060	16,00	24,00	0,117	6,40	40,00
16	10°	0,060	16,00	24,00	0,117	6,40	40,00
20	20°	0,108	20,00	30,00	0,209	8,00	50,00
20	20°	0,108	20,00	30,00	0,209	8,00	50,00
20	10°	0,076	20,00	30,00	0,146	8,00	50,00
20	10°	0,076	20,00	30,00	0,146	8,00	50,00

Abmessungen in mm
Dimensions in mm





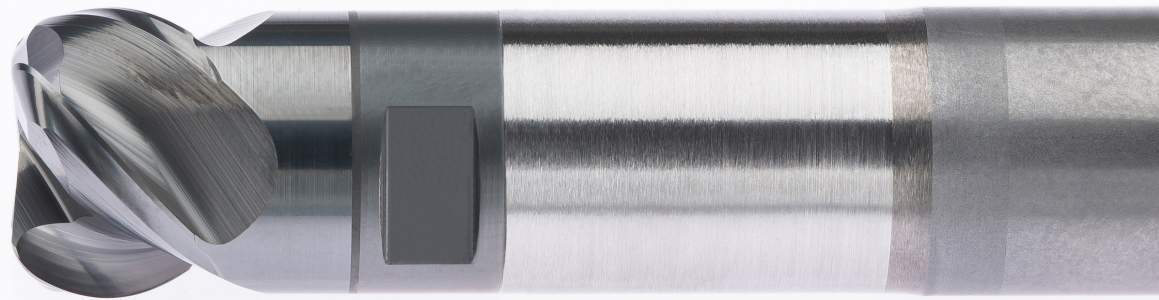

Frässystem DG

für

- Bohrnutenfräsen
- Fasen und Anbohren
- Kopierfräsen
- Hochvorschubsfräsen
- Verzahnungsfräsen

Milling system DG

for

- Centre Cutting and Groove Milling
- Chamfering and Centering
- Copy Milling
- High Feed Milling
- Gear Milling

C

Fräuserschaft
Milling shank
MDG

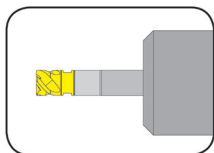

Seite/Page
C3-C6

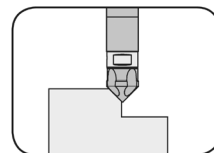

Seite/Page
C24

Schneidplatte
Insert
DGR

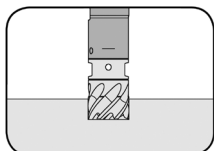

Seite/Page
C8

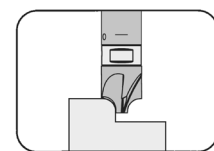

Seite/Page
C26

Schneidkopf
Cutter Head
DGR/DGF/DGRR/
DGH/DGM/DGK/
DGVZ/DGFF/DGV

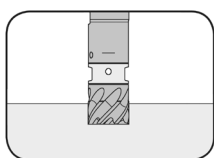

Seite/Page
C10, C12

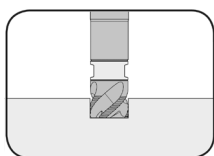

Seite/Page
C14

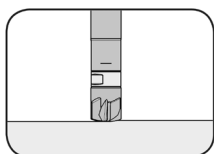

Seite/Page
C16

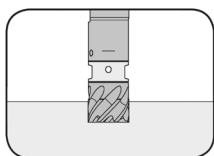

Seite/Page
C18

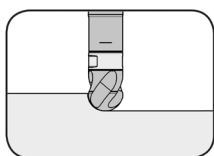

Seite/Page
C20

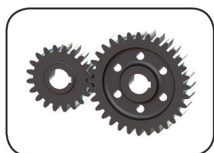

Seite/Page
C22

Nutfräsen

Groove milling



Frälerschaft

Milling shank

MDG

mit innerer Kühlmittelzufuhr
with through coolant supply

90° Aufnahmeschaft - schrumpfbar
Shank 90° - shrink fit

Schaftmaterial: Hartmetall
Material of shank: Carbide

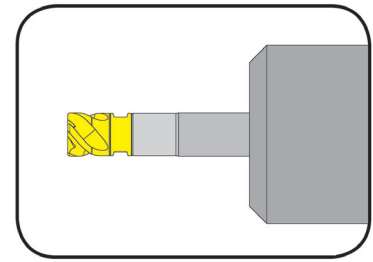

C

Schneidkopf
Cutter Head

Typ DGK
Type DGM
 DGF
 DGR
 DGRR
 DGFF
 DGH
 DGV
 DGVZ

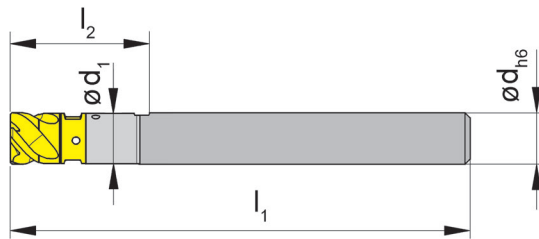

Bestellnummer Part number	d	l ₁	l ₂	d ₁	System System
MDG.10.0010.90.00.A	10	72,8	30,0	9,8	DG10
MDG.10.0010.90.01.A	10	101,8	56,8	9,8	DG10
MDG.12.0012.90.00.A	12	83,3	36,0	11,7	DG12
MDG.12.0012.90.01.A	12	114,3	59,3	11,7	DG12
MDG.16.0016.90.00.A	16	98,8	48,0	15,6	DG16
MDG.16.0016.90.01.A	16	129,8	64,8	15,6	DG16
MDG.20.0020.90.00.A	20	112,3	60,0	19,5	DG20
MDG.20.0020.90.01.A	20	150,3	70,3	19,5	DG20

Weitere Abmessungen auf Anfrage
Further sizes upon request

Abmessungen in mm
Dimensions in mm

Bei Frälerschäften MDG10... ist das Gewinde **NICHT** segmentiert!
For toolholders MDG10... Please note the threads are **NOT** segmented.

Ersatzteile

Schlüssel und Zubehör sind nicht im Lieferumfang enthalten - bitte separat bestellen. Details und erforderliche Anzugsmomente finden Sie in den Technischen Daten auf Seite C7.

Spare Parts

Wrenches and additional equipment are not combined with the milling shank. Separate order required! For more details and torque specifications please see the technical data on page C7.

Frälerschäfte mit beschädigter Schneidkopfaufnahme können durch unseren Reparaturservice instand gesetzt werden.
Milling cutter shanks with damaged seating can be repaired by HORN.

Nutfräsen

Groove milling



Frälerschaft

Milling shank

MDG

ohne Kühlmittelzufuhr
no coolant supply

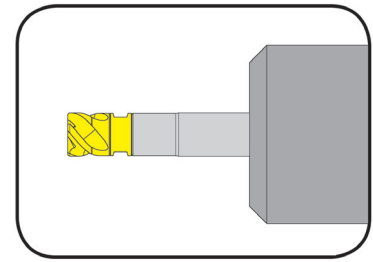

90° Aufnahmeschaft - nicht schrumpfbar
Shank 90° - not recommended for shrinking

Schaftmaterial: Stahl
Material of shank: Steel

Schneidkopf
Cutter Head

Typ
Type

- DGK
- DGM
- DGF
- DGR
- DGRR
- DGFF
- DGH
- DGV
- DGVZ

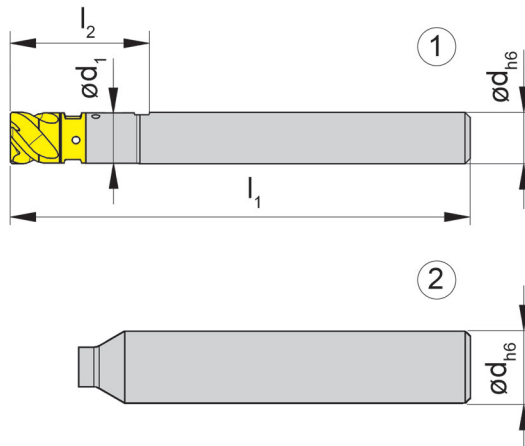

Bestellnummer Part number	d	l ₁	l ₂	d ₁	Form Form
MDG.10.ST10.90.01.A	10	91,8	36,8	9,8	1
MDG.10.ST16.90.01.A	16	91,8	19,8	9,8	2
MDG.12.ST12.90.01.A	12	109,3	44,3	11,7	1
MDG.12.ST16.90.01.A	16	99,3	22,3	11,7	2
MDG.16.ST16.90.01.A	16	134,8	49,8	15,6	1
MDG.16.ST20.90.01.A	20	104,8	27,8	15,6	2
MDG.20.ST20.90.01.A	20	150,3	60,3	19,5	1
MDG.20.ST25.90.01.A	25	110,3	33,3	19,5	2

Weitere Abmessungen auf Anfrage
Further sizes upon request

Abmessungen in mm
Dimensions in mm

Bei Frälerschäften MDG10... ist das Gewinde **NICHT** segmentiert!
For toolholders MDG10... Please note the threads are **NOT** segmented.

Ersatzteile

Schlüssel und Zubehör sind nicht im Lieferumfang enthalten - bitte separat bestellen. Details und erforderliche Anzugsmomente finden Sie in den Technischen Daten auf Seite C7.

Spare Parts

Wrenches and additional equipment are not combined with the milling shank. Separate order required! For more details and torque specifications please see the technical data on page C7.

Frälerschäfte mit beschädigter Schneidkopfaufnahme können durch unseren Reparaturservice instand gesetzt werden.
Milling cutter shanks with damaged seating can be repaired by HORN.

Nutfräsen

Groove milling



Frälerschaft

Milling shank

MDG

mit innerer Kühlmittelzufuhr
with through coolant supply

87° Aufnahmeschaft - schrumpfbar
Shank 87° - shrink fit

Schaftmaterial: Hartmetall
Material of shank: Carbide

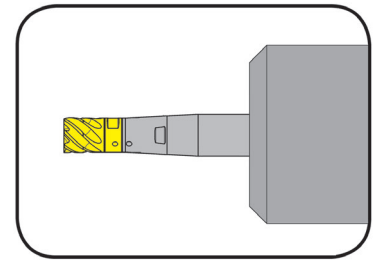

C

Schneidkopf
Cutter Head

Typ DGK
Type DGM
DGF
DGR
DGRR
DGFF
DGH
DGV
DGVZ

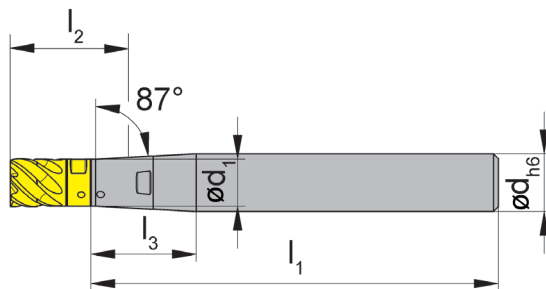

Bestellnummer Part number	d	l ₁	l ₂	d ₁	l ₃
MDG.10.0012.87.01.A	12	85	19,7	9,8	22
MDG.12.0016.87.01.A	16	100	23,1	11,7	42
MDG.16.0020.87.01.A	20	100	29,6	15,6	43

Weitere Abmessungen auf Anfrage
Further sizes upon request

Abmessungen in mm
Dimensions in mm

Bei Frälerschäften MDG10... ist das Gewinde **NICHT** segmentiert!
For toolholders MDG10... Please note the threads are **NOT** segmented.

Ersatzteile

Schlüssel und Zubehör sind nicht im Lieferumfang enthalten - bitte separat bestellen. Details und erforderliche Anzugsmomente finden Sie in den Technischen Daten auf Seite C7.

Spare Parts

Wrenches and additional equipment are not combined with the milling shank. Separate order required! For more details and torque specifications please see the technical data on page C7.

Frälerschäfte mit beschädigter Schneidkopfaufnahme können durch unseren Reparaturservice instand gesetzt werden.
Milling cutter shanks with damaged seating can be repaired by HORN.

Nutfräsen

Groove milling



Frälerschaft

Milling shank

MDG

mit innerer Kühlmittelzufuhr
with through coolant supply

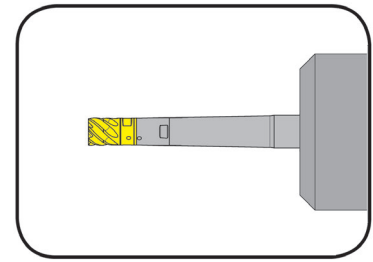

89° Aufnahmeschaft - schrumpfbar
Shank 89° - shrink fit

Schaftmaterial: Hartmetall
Material of shank: Carbide

Schneidkopf
Cutter Head

Typ DGK
Type DGM
DGF
DGR
DGRR
DGFF
DGH
DGV
DGVZ

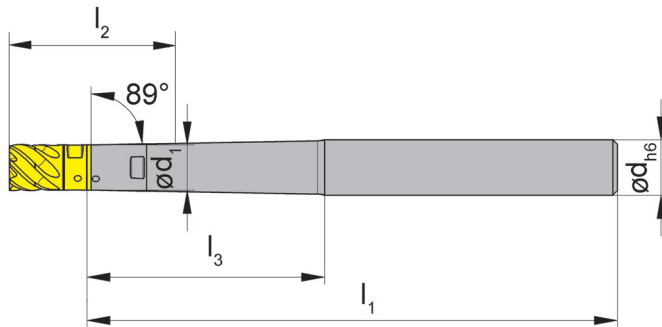

Bestellnummer Part number	d	l ₁	l ₂	d ₁	l ₃
MDG.10.0012.89.01.A	12	115	23,5	9,8	50
MDG.12.0016.89.01.A	16	140	28,8	11,7	75
MDG.16.0020.89.01.A	20	160	37,2	15,6	75

Weitere Abmessungen auf Anfrage
Further sizes upon request

Abmessungen in mm
Dimensions in mm

Bei Frälerschäften MDG10... ist das Gewinde **NICHT** segmentiert!
For toolholders MDG10... Please note the threads are **NOT** segmented.

Ersatzteile

Schlüssel und Zubehör sind nicht im Lieferumfang enthalten - bitte separat bestellen. Details und erforderliche Anzugsmomente finden Sie in den Technischen Daten auf Seite C7.

Spare Parts

Wrenches and additional equipment are not combined with the milling shank. Separate order required! For more details and torque specifications please see the technical data on page C7.

Frälerschäfte mit beschädigter Schneidkopfaufnahme können durch unseren Reparaturservice instand gesetzt werden.
Milling cutter shanks with damaged seating can be repaired by HORN.

Anzugsmoment Torque for setting

System System	Anzugsmoment (Nm) Torque for setting (Nm)	Schlüsselweite Wrench size SW	Maulschlüssel Combination wrench	Drehmomentschlüssel Torque wrench		
				Einsatz Application	Messbereich Effective range	für Kleinserien for small series
DG10	10	8	S.DG1012	D.DG1001	D0525VK 5 - 25 Nm	D1050VK 10 - 50 Nm
DG12	14	10		D.DG1201		
DG16	25	13	S.DG1620	D.DG1601	D20100VK 20 - 100 Nm	
DG20	35	17		D.DG2001		

Montageanleitung

1. Reinigen Sie die Schnittstelle und Plananlage am Frälerschaft und am Schneideinsatz
2. Spannen Sie den Frälerschaft in der Aufnahme
3. Tragen Sie Schmierstoff im Bereich des Gewindes und der Kegel- und Plananlage des Schneideinsatzes auf
4. Fügen Sie den Schneideinsatz gemäß Markierung in den Schaft und drehen Sie von Hand an -
Vorsicht Verletzungsgefahr!
5. Ziehen Sie den Schneideinsatz im Frälerschaft mit dem entsprechenden Drehmoment mit Hilfe eines Drehmomentschlüssels an.

Hinweise:

Die Verwendung von Schmierstoff reduziert die Reibung zwischen Schneideinsatz und Halter. Die Sauberkeit der Schnittstellen ist sehr wichtig für eine hohe Rund- und Planlaufgenauigkeit. Das Anziehen der Schneideinsätze mit dem vorgeschriebenen Drehmoment stellt die Plananlage in der Schnittstelle sicher.

Assembly instruction

1. Remove any dirt from the interface and seating surface of the milling cutter shank and cutting insert.
2. Grip milling cutter shank in jig.
3. Apply lubricant sparingly to thread, taper and seat surface of cutting insert.
4. Insert cutting insert into shank and clamp it manually according to mark.
Attention: risk of injury!
5. Tighten cutting insert in milling cutter shank with a torque wrench, using the recommended torque.

Note:

The use of lubricant reduces friction between cutting insert and tool holder. For optimum radial and axial run-out precision it is crucial that interfaces and seat surfaces are clean. Applying the recommended tightening torque for gripping cutting inserts guarantees the correct insert fit.



Schneidkopf

Cutter Head

DGR...IK

mit innerer Kühlmittelzufuhr
with through coolant supply

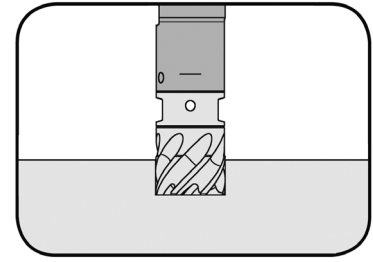

Schneidkopf mit Eckenradius
Cutter head with corner radius

für Frälerschaft
for Milling shank

Typ MDG
Type



Abbildung = rechtsschneidend
Picture = right hand cutting version

Stirnschneide nicht über
Mitte schneidend
face cutting edge not cutting
across centre

Bestellnummer Part number	System System	SW	Z	d ₁	d ₃	r	l ₃	l ₂	AN2P
DGR.3.10.1000.05.IK	DG10	8	3	10	9,8	0,5	16,8	5,5	▲
DGR.3.10.1000.10.IK	DG10	8	3	10	9,8	1,0	16,8	5,5	▲
DGR.4.10.1000.05.IK	DG10	8	4	10	9,8	0,5	16,8	5,5	▲
DGR.4.10.1000.10.IK	DG10	8	4	10	9,8	1,0	16,8	5,5	▲
DGR.3.12.1200.05.IK	DG12	10	3	12	11,7	0,5	19,3	6,5	▲
DGR.4.12.1200.05.IK	DG12	10	4	12	11,7	0,5	19,3	6,5	▲
DGR.4.12.1200.10.IK	DG12	10	4	12	11,7	1,0	19,3	6,5	▲
DGR.5.16.1600.05.IK	DG16	13	5	16	15,6	0,5	24,8	8,5	▲
DGR.5.16.1600.10.IK	DG16	13	5	16	15,6	1,0	24,8	8,5	▲
DGR.5.16.1600.15.IK	DG16	13	5	16	15,6	1,5	24,8	8,5	▲
DGR.5.16.1600.20.IK	DG16	13	5	16	15,6	2,0	24,8	8,5	▲

▲ ab Lager / on stock Δ 4 Wochen / 4 weeks x auf Anfrage / upon request

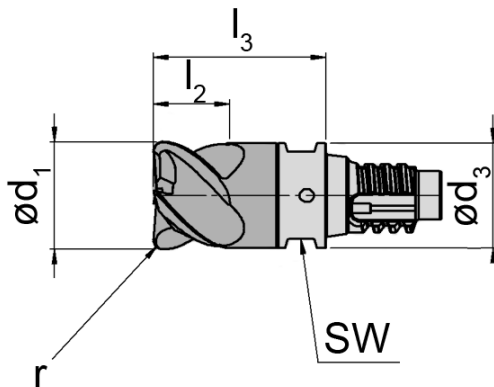
● empfohlen / recommended

o bedingt einsetzbar / alternative recommendation

- nicht geeignet / not suitable

■ unbeschichtete HM-Sorten / uncoated grades

■ beschichtete HM-Sorten / coated grades



■ bestückt/Cermet / brazed/Cermet

Abmessungen in mm



Dimensions in mm

P	•
M	•
K	•
N	-
S	•
H	o

HM-Sorten
Carbide grades

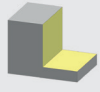
	 $vc = m/min$	 $vc = m/min$
P1.1	150	180
P1.2	150	180
P1.3	140	170
P2.1	130	160
P2.2	130	160
P2.3	130	160
P3.1	110	130
P3.2	100	120
M1.1	90	110
M2.1	70	80
M3.1	60	70

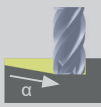
	 $vc = m/min$	 $vc = m/min$
K1.1	130	160
K1.2	110	130
K2.1	110	130
K2.2	100	120
K3.1	80	100
K3.2	70	80
S1.1	65	80
S2.1	45	50
S3.1	35	40
-	-	-
-	-	-

d_1							
		f_z	a_e	a_p	f_z	a_e	a_p
10	5°	0,05	10	5	0,07	4	5
10	5°	0,05	10	5	0,07	4	5
10	4°	0,05	10	5	0,06	4	5
10	4°	0,05	10	5	0,06	4	5
12	5°	0,06	12	6	0,09	5	6
12	4°	0,06	12	6	0,08	5	6
12	4°	0,06	12	6	0,08	5	6
16	3°	0,08	16	8	0,11	6	8
16	3°	0,08	16	8	0,11	6	8
16	3°	0,08	16	8	0,11	6	8
16	3°	0,08	16	8	0,11	6	8
20	3°	0,10	20	10	0,14	8	10
20	3°	0,10	20	10	0,14	8	10

Abmessungen in mm
Dimensions in mm

C

Schneidkopf

Cutter Head

DGR

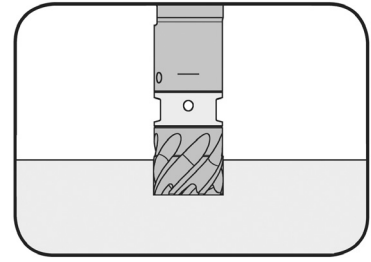

Schneidkopf mit Eckenradius
Cutter head with corner radius

für Fräseschaft
for Milling shank

Typ MDG
Type



Abbildung = rechtsschneidend
Picture = right hand cutting version

Stirnschneide über Mitte
schneidend
face cutting edge cutting
across centre

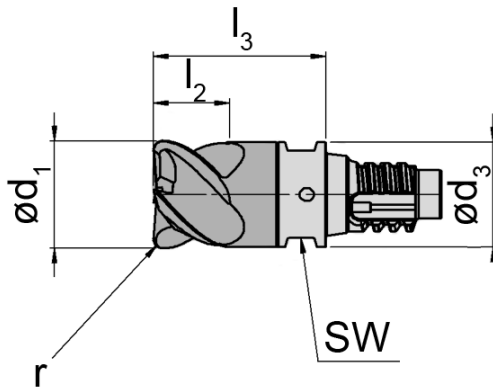

Bestellnummer Part number	System System	SW	Z	d ₁	d ₃	r	l ₃	l ₂	AN2P
DGR.3.10.1000.05.00	DG10	8	3	10	9,8	0,5	16,8	5,5	▲
DGR.3.10.1000.10.00	DG10	8	3	10	9,8	1,0	16,8	5,5	▲
DGR.4.10.1000.05.00	DG10	8	4	10	9,8	0,5	16,8	5,5	▲
DGR.4.10.1000.10.00	DG10	8	4	10	9,8	1,0	16,8	5,5	▲
DGR.3.12.1200.05.00	DG12	10	3	12	11,7	0,5	19,3	6,5	▲
DGR.4.12.1200.05.00	DG12	10	4	12	11,7	0,5	19,3	6,5	▲
DGR.4.12.1200.10.00	DG12	10	4	12	11,7	1,0	19,3	6,5	▲
DGR.5.16.1600.05.00	DG16	13	5	16	15,6	0,5	24,8	8,5	▲
DGR.5.16.1600.10.00	DG16	13	5	16	15,6	1,0	24,8	8,5	▲
DGR.5.16.1600.15.00	DG16	13	5	16	15,6	1,5	24,8	8,5	▲
DGR.5.16.1600.20.00	DG16	13	5	16	15,6	2,0	24,8	8,5	▲
DGR.5.20.2000.05.00	DG20	17	5	20	19,5	0,5	30,3	12,0	▲
DGR.5.20.2000.10.00	DG20	17	5	20	19,5	1,0	30,3	12,0	▲
DGR.5.20.2000.15.00	DG20	17	5	20	19,5	1,5	30,3	12,0	▲
DGR.5.20.2000.20.00	DG20	17	5	20	19,5	2,0	30,3	12,0	▲

- ▲ ab Lager / on stock Δ 4 Wochen / 4 weeks x auf Anfrage / upon request
- empfohlen / recommended
- o bedingt einsetzbar / alternative recommendation
- nicht geeignet / not suitable
- unbeschichtete HM-Sorten / uncoated grades
- beschichtete HM-Sorten / coated grades
- bestückt/Cermet / brazed/Cermet



Abmessungen in mm
Dimensions in mm

HM-Sorten
Carbide grades

P	•
M	•
K	•
N	-
S	•
H	o

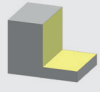
	 $vc = m/min$	 $vc = m/min$
P1.1	150	180
P1.2	150	180
P1.3	140	170
P2.1	130	160
P2.2	130	160
P2.3	130	160
P3.1	110	130
P3.2	100	120
M1.1	90	110
M2.1	70	80
M3.1	60	70

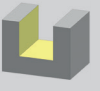
	 $vc = m/min$	 $vc = m/min$
K1.1	130	160
K1.2	110	130
K2.1	110	130
K2.2	100	120
K3.1	80	100
K3.2	70	80
S1.1	65	80
S2.1	45	50
S3.1	35	40
-	-	-
-	-	-

d_1	 α						
		f_z	a_e	a_p	f_z	a_e	a_p
10	5°	0,04	10	5	0,07	4	5
10	5°	0,04	10	5	0,07	4	5
10	4°	0,04	10	5	0,06	4	5
10	4°	0,04	10	5	0,06	4	5
12	5°	0,05	12	6	0,09	5	6
12	4°	0,05	12	6	0,08	5	6
12	4°	0,05	12	6	0,08	5	6
16	3°	0,07	16	8	0,11	6	8
16	3°	0,07	16	8	0,11	6	8
16	3°	0,07	16	8	0,11	6	8
16	3°	0,07	16	8	0,11	6	8
20	3°	0,09	20	10	0,14	8	10
20	3°	0,09	20	10	0,14	8	10
20	3°	0,09	20	10	0,14	8	10
20	3°	0,09	20	10	0,14	8	10

Abmessungen in mm
Dimensions in mm

C

Schneidkopf

Cutter Head

DGF

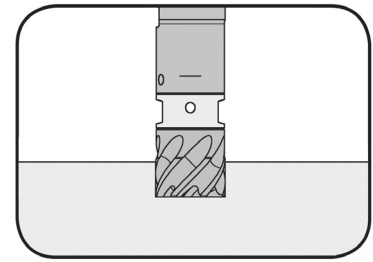

Schneidkopf mit Eckfase
Cutter head with corner chamfer

für Fräseschaft
for Milling shank

Typ MDG
Type

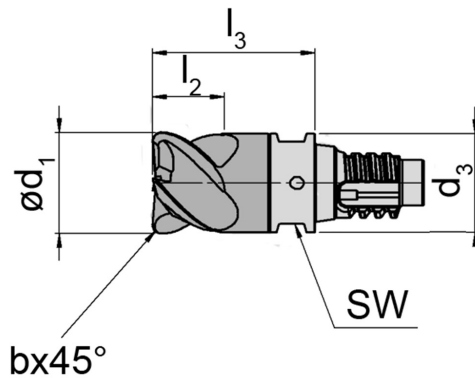

Stirnschneide über Mitte
schneidend
face cutting edge cutting
across centre

Abbildung = rechtsschneidend
Picture = right hand cutting version

Bestellnummer Part number	System System	SW	Z	d ₁	d ₃	l ₃	l ₂	b	AN2P
DGF.3.10.1000.02.00	DG10	8	3	10	9,8	16,8	5,5	0,20	▲
DGF.3.12.1200.02.00	DG12	10	3	12	11,7	19,3	6,5	0,20	▲
DGF.4.16.1600.02.00	DG16	13	4	16	15,6	24,8	8,5	0,20	▲
DGF.4.20.2000.03.00	DG20	17	4	20	19,5	30,3	12,0	0,25	▲

▲ ab Lager / on stock Δ 4 Wochen / 4 weeks x auf Anfrage / upon request

● empfohlen / recommended

o bedingt einsetzbar / alternative recommendation

- nicht geeignet / not suitable

□ unbeschichtete HM-Sorten / uncoated grades

■ beschichtete HM-Sorten / coated grades

■ bestückt/Cermet / brazed/Cermet

Abmessungen in mm

Dimensions in mm

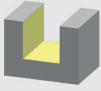
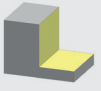

P	●
M	●
K	●
N	-
S	●
H	○

HM-Sorten
Carbide grades

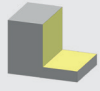
	 $vc = m/min$	 $vc = m/min$
P1.1	140	170
P1.2	140	170
P1.3	130	160
P2.1	120	140
P2.2	120	140
P2.3	120	140
P3.1	100	120
P3.2	90	110
M1.1	80	100
M2.1	60	70
M3.1	50	60

	 $vc = m/min$	 $vc = m/min$
K1.1	120	140
K1.2	100	120
K2.1	100	120
K2.2	90	110
K3.1	70	80
K3.2	60	70
S1.1	55	70
S2.1	40	50
S3.1	30	40
-	-	-
-	-	-



d_1							
		f_z	a_e	a_p	f_z	a_e	a_p
10	5°	0,04	10	5	0,07	4	5
12	5°	0,05	12	6	0,09	5	6
16	4°	0,07	16	8	0,11	6	8
20	4°	0,09	20	10	0,14	8	10

Abmessungen in mm
Dimensions in mm

Schruppfräser

Roughing End Mill



Schneidkopf

Cutter Head

DGRR

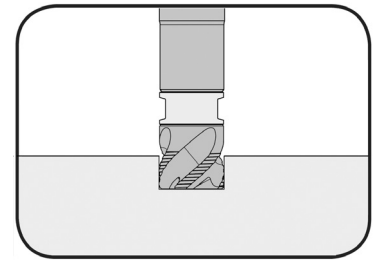

Schneidkopf mit Eckfase
Cutter head with corner chamfer

für Fräseschaft
for Milling shank

Typ MDG
Type

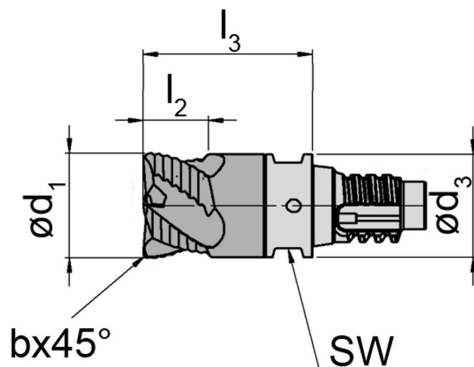

Stirnschneide über Mitte
schneidend
face cutting edge cutting
across centre

Abbildung = rechtsschneidend
Picture = right hand cutting version

Bestellnummer Part number	System System	SW	Z	d ₁	d ₃	l ₃	l ₂	b	AN2P
DGRR.3.10.1000.00	DG10	8	3	10	9,8	16,8	5,5	0,3	▲
DGRR.4.10.1000.00	DG10	8	4	10	9,8	16,8	5,5	0,3	▲
DGRR.3.12.1200.00	DG12	10	3	12	11,7	19,3	6,5	0,5	▲
DGRR.4.12.1200.00	DG12	10	4	12	11,7	19,3	6,5	0,5	▲
DGRR.5.16.1600.00	DG16	13	5	16	15,6	24,8	8,5	0,5	▲
DGRR.5.20.2000.00	DG20	17	5	20	19,5	30,3	12,0	0,5	▲

▲ ab Lager / on stock Δ 4 Wochen / 4 weeks x auf Anfrage / upon request

● empfohlen / recommended

o bedingt einsetzbar / alternative recommendation

- nicht geeignet / not suitable

■ unbeschichtete HM-Sorten / uncoated grades

■ beschichtete HM-Sorten / coated grades

■ bestückt/Cermet / brazed/Cermet

Abmessungen in mm



Dimensions in mm

P	●
M	●
K	●
N	-
S	●
H	○

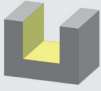
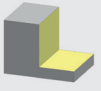
HM-Sorten
Carbide grades

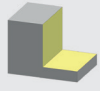
	 vc = m/min	 vc = m/min
P1.1	120	140
P1.2	120	140
P1.3	110	130
P2.1	110	130
P2.2	110	130
P2.3	110	130
P3.1	100	120
P3.2	100	120
M1.1	70	80
M2.1	60	70
M3.1	50	60

	 vc = m/min	 vc = m/min
K1.1	110	130
K1.2	100	120
K2.1	100	120
K2.2	80	100
K3.1	60	70
K3.2	60	70
S1.1	50	60
S2.1	40	50
S3.1	30	40
-	-	-
-	-	-

d_1							
		f_z	a_e	a_p	f_z	a_e	a_p
10	5°	0,06	10	5	0,07	8	5
10	4°	0,05	10	5	0,06	8	5
12	3°	0,06	12	6	0,07	9	6
12	3°	0,06	12	6	0,07	9	6
16	3°	0,09	16	8	0,10	12	8
20	3°	0,11	20	10	0,13	15	10

Abmessungen in mm
Dimensions in mm

C

Schneidkopf

Cutter Head

DGH

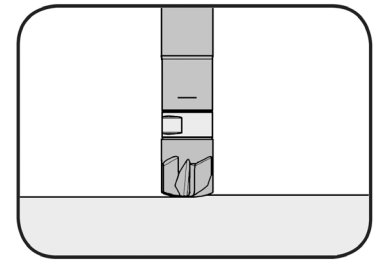

Schneidkopf mit Eckenradius
Cutter head with corner radius

für Fräseschaft
for Milling shank

Typ MDG
Type

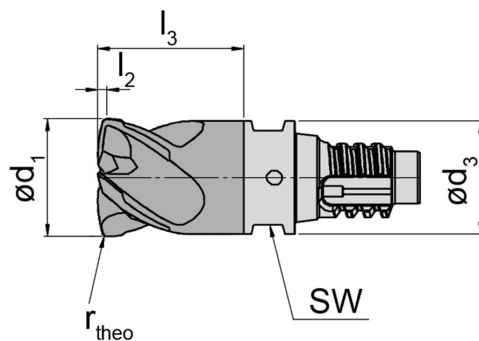

Stirnschneide nicht über
Mitte schneidend
face cutting edge not cutting
across centre

Abbildung = rechtsschneidend
Picture = right hand cutting version

Bestellnummer Part number	System System	SW	Z	d ₁	d ₃	l ₃	l ₂	r _{theo}	AN2P
DGH.4.10.1000.00	DG10	8	4	10	9,8	16,8	0,7	1,07	▲
DGH.4.12.1200.00	DG12	10	4	12	11,7	19,3	0,8	1,18	▲
DGH.4.16.1600.00	DG16	13	4	16	15,6	24,8	1,0	1,38	▲
DGH.4.20.2000.00	DG20	17	4	20	19,5	30,3	1,2	1,96	▲

▲ ab Lager / on stock Δ 4 Wochen / 4 weeks x auf Anfrage / upon request

● empfohlen / recommended

o bedingt einsetzbar / alternative recommendation

- nicht geeignet / not suitable

■ unbeschichtete HM-Sorten / uncoated grades

■ beschichtete HM-Sorten / coated grades

■ bestückt/Cermet / brazed/Cermet

Abmessungen in mm

Dimensions in mm

P	●
M	●
K	●
N	-
S	●
H	○

HM-Sorten
Carbide grades



Schnittdaten DGH

Cutting Data DGH

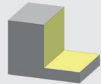
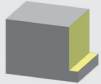

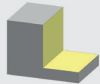
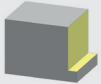
	 vc = m/min	 vc = m/min
P1.1	160	190
P1.2	160	190
P1.3	160	190
P2.1	150	180
P2.2	140	170
P2.3	140	170
P3.1	130	160
P3.2	130	160
M1.1	110	130
M2.1	100	120
M3.1	90	110

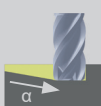
	 vc = m/min	 vc = m/min
K1.1	130	160
K1.2	130	160
K2.1	120	140
K2.2	120	140
K3.1	110	130
K3.2	110	130
S1	90	110
S2	70	80
S3	60	70
-	-	-
-	-	-

d_1							
		f_z	a_e	a_p	f_z	a_e	a_p
10	4°	0,39	10	0,4	0,59	7	0,6
12	4°	0,47	12	0,5	0,71	8	0,7
16	4°	0,63	16	0,6	0,94	11	0,9
20	4°	0,79	20	0,8	1,18	14	1,1

Abmessungen in mm
Dimensions in mm



Schneidkopf

Cutter Head

DGM

mehrschneidig
multiple fluted

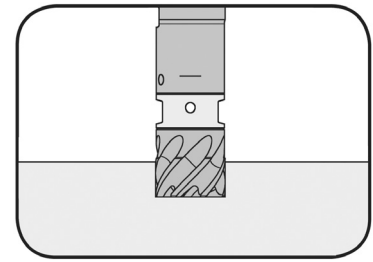

für Fräseschaft
for Milling shank

Typ MDG
Type



Abbildung = rechtsschneidend
Picture = right hand cutting version

Stirnschneide nicht über
Mitte schneidend
face cutting edge not cutting
across centre

Bestellnummer Part number	System System	SW	Z	d ₁	d ₃	r	l ₃	l ₂	AN2P
DGM.7.10.1000.02.0	DG10	8	7	10	9,8	0,2	16,8	5,5	▲
DGM.7.10.1000.10.0	DG10	8	7	10	9,8	1,0	16,8	5,5	▲
DGM.7.12.1200.02.0	DG12	10	7	12	11,7	0,2	19,3	6,5	▲
DGM.7.12.1200.10.0	DG12	10	7	12	11,7	1,0	19,3	6,5	▲
DGM.9.16.1600.02.0	DG16	13	9	16	15,6	0,2	24,8	9,0	▲
DGM.9.16.1600.10.0	DG16	13	9	16	15,6	1,0	24,8	9,0	▲
DGM.9.20.2000.02.0	DG20	17	9	20	19,5	0,2	30,3	11,0	▲
DGM.9.20.2000.10.0	DG20	17	9	20	19,5	1,0	30,3	11,0	▲

▲ ab Lager / on stock Δ 4 Wochen / 4 weeks x auf Anfrage / upon request

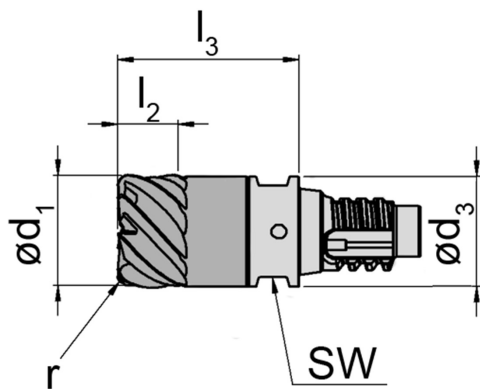
● empfohlen / recommended

o bedingt einsetzbar / alternative recommendation

- nicht geeignet / not suitable

■ unbeschichtete HM-Sorten / uncoated grades

■ beschichtete HM-Sorten / coated grades

■ bestückt/Cermet / brazed/Cermet

Abmessungen in mm



Dimensions in mm

P	•
M	•
K	•
N	-
S	•
H	○

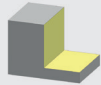
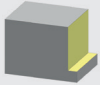
HM-Sorten
Carbide grades

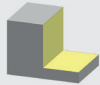
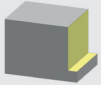
	 vc = m/min	 vc = m/min
P1.1	140	170
P1.2	140	170
P1.3	130	160
P2.1	120	140
P2.2	120	140
P2.3	120	140
P3.1	100	120
P3.2	90	110
M1.1	80	100
M2.1	60	70
M3.1	50	60

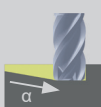
	 vc = m/min	 vc = m/min
K1.1	120	140
K1.2	100	120
K2.1	100	120
K2.2	90	110
K3.1	70	80
K3.2	60	70
S1	55	70
S2	40	50
S3	30	40
-	-	-
-	-	-

d_1	 α						
		f_z	a_e	a_p	f_z	a_e	a_p
10	2°	0,04	1,0	5,0	0,06	0,20	5,00
10	2°	0,04	1,0	5,0	0,06	0,20	5,00
12	2°	0,05	1,2	6,0	0,08	0,24	6,00
12	2°	0,05	1,2	6,0	0,08	0,24	6,00
16	2°	0,07	1,6	8,0	0,11	0,32	8,00
16	2°	0,07	1,6	8,0	0,11	0,32	8,00
20	2°	0,10	2,0	10,0	0,17	0,40	10,00
20	2°	0,10	2,0	10,0	0,17	0,40	10,00

Abmessungen in mm
Dimensions in mm

C

Schneidkopf

Cutter Head

DGK

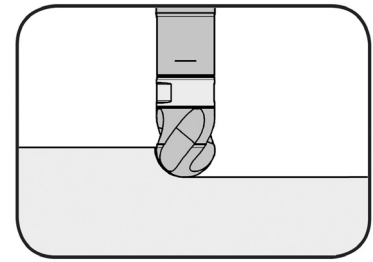

Kugelfräser 180°
Ballnose milling head 180°

für Fräseschaft
for Milling shank

Typ MDG
Type

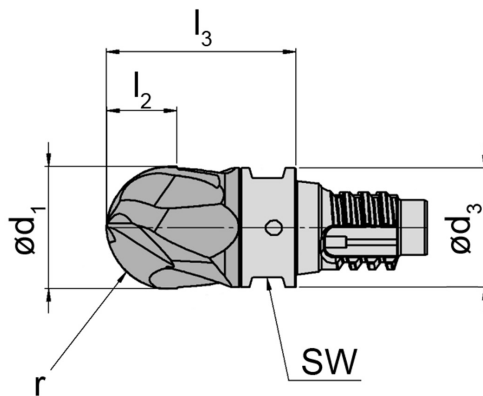

Stirnschneide über Mitte
schneidend
face cutting edge cutting
across centre

Abbildung = rechtsschneidend
Picture = right hand cutting version

Bestellnummer Part number	System System	SW	Z	d ₁	d ₃	r	l ₃	l ₂	AN2P
DGK.2.10.1000.00	DG10	8	2	10	9,8	5	16,8	5,5	▲
DGK.4.10.1000.00	DG10	8	4	10	9,8	5	16,8	5,5	▲
DGK.2.12.1200.00	DG12	10	2	12	11,7	6	19,3	6,5	▲
DGK.4.12.1200.00	DG12	10	4	12	11,7	6	19,3	6,5	▲
DGK.2.16.1600.00	DG16	13	2	16	15,6	8	24,8	8,5	▲
DGK.4.16.1600.00	DG16	13	4	16	15,6	8	24,8	8,5	▲
DGK.2.20.2000.00	DG20	17	2	20	19,5	10	30,3	12,0	▲
DGK.4.20.2000.00	DG20	17	4	20	19,5	10	30,3	12,0	▲

▲ ab Lager / on stock Δ 4 Wochen / 4 weeks x auf Anfrage / upon request

● empfohlen / recommended

o bedingt einsetzbar / alternative recommendation

- nicht geeignet / not suitable

■ unbeschichtete HM-Sorten / uncoated grades

■ beschichtete HM-Sorten / coated grades



■ bestückt/Cermet / brazed/Cermet



Abmessungen in mm

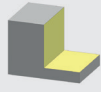

Dimensions in mm

P	●
M	●
K	○
N	○
S	○
H	○

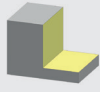
HM-Sorten
Carbide grades

	 $vc = m/min$	 $vc = m/min$
P1.1	140	170
P1.2	140	170
P1.3	130	160
P2.1	120	140
P2.2	120	140
P2.3	120	140
P3.1	100	120
P3.2	90	110
M1.1	80	100
M2.1	60	70
M3.1	50	60

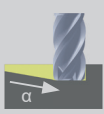
	 $vc = m/min$	 $vc = m/min$
K1.1	120	140
K1.2	100	120
K2.1	100	120
K2.2	90	110
K3.1	70	80
K3.2	60	70
S1	55	70
S2	40	50
S3	30	40
-	-	-
-	-	-

d_1							
		f_z	a_e	a_p	f_z	a_e	a_p
10	5°	0,08	3	3	0,09	0,10	0,50
10	4°	0,05	3	3	0,07	0,10	0,50
12	5°	0,09	4	4	0,10	0,12	0,60
12	4°	0,06	4	4	0,08	0,12	0,60
16	5°	0,11	5	5	0,13	0,16	0,80
16	4°	0,08	5	5	0,11	0,16	0,80
20	5°	0,13	6	6	0,15	0,20	1,00
20	4°	0,10	6	6	0,13	0,20	1,00

Abmessungen in mm
Dimensions in mm

C

Schneidkopf

Cutter Head

DGVZ

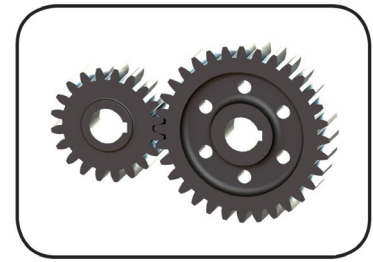

Schneidkopf Vollradius, konisch
Cutter head conical ball nose

für Fräaserschaft
for Milling shank

Typ MDG
Type

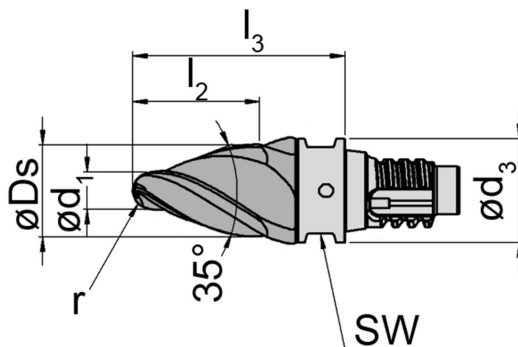

Stirnschneide über Mitte
schneidend
face cutting edge cutting
across centre

Abbildung = rechtsschneidend
Picture = right hand cutting version

Bestellnummer Part number	System System	SW	Z	Ds	d ₃	r	l ₃	d ₁	l ₂	AN2P
DGVZ.4.10.35.15.00	DG10	8	4	10	9,8	1,5	21	2,86	12,30	▲
DGVZ.4.12.35.20.00	DG12	10	4	12	11,7	2,0	24	3,82	14,30	▲
DGVZ.6.16.35.30.00	DG16	13	6	16	15,6	3,0	32	5,72	18,40	▲
DGVZ.6.20.35.50.00	DG20	17	6	20	19,5	5,0	37	9,54	20,09	▲

▲ ab Lager / on stock Δ 4 Wochen / 4 weeks x auf Anfrage / upon request

● empfohlen / recommended

o bedingt einsetzbar / alternative recommendation

- nicht geeignet / not suitable

■ unbeschichtete HM-Sorten / uncoated grades

■ beschichtete HM-Sorten / coated grades

■ bestückt/Cermet / brazed/Cermet

Abmessungen in mm

Dimensions in mm

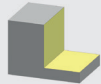
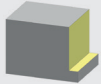

P	●
M	●
K	○
N	○
S	○
H	○

HM-Sorten
Carbide grades

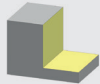
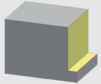
	 vc = m/min	 vc = m/min
P1.1	140	170
P1.2	140	170
P1.3	130	160
P2.1	120	140
P2.2	120	140
P2.3	120	140
P3.1	100	120
P3.2	90	110
M1.1	80	100
M2.1	60	70
M3.1	50	60

	 vc = m/min	 vc = m/min
K1.1	120	140
K1.2	100	120
K2.1	100	120
K2.2	90	110
K3.1	70	80
K3.2	60	70
S1	55	70
S2	40	50
S3	30	40
-	-	-
-	-	-

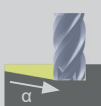

d_1							
		f_z	a_e	a_p	f_z	a_e	a_p
10	4°	0,06	1,0	5,0	0,11	0,20	5,00
12	4°	0,06	1,0	5,0	0,11	0,20	5,00
16	2°	0,05	1,2	6,0	0,09	0,24	6,00
20	2°	0,05	1,2	6,0	0,09	0,24	6,00

Abmessungen in mm
Dimensions in mm

Fasen Chamfering



Schneidkopf Cutter Head

DGFF

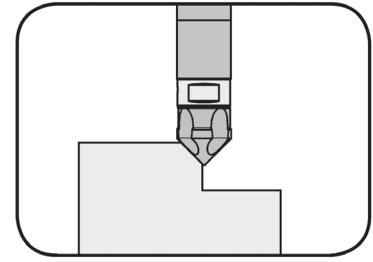

Faswinkel Angle of chamfer 45 °

für Fräseschaft
for Milling shank

Typ MDG
Type

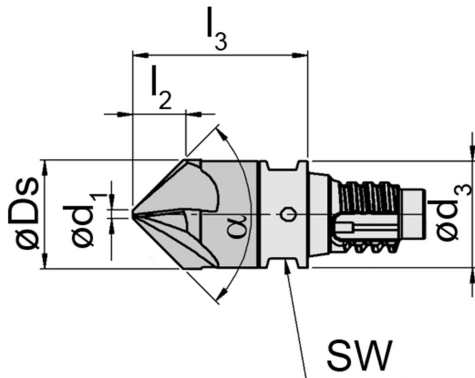

nicht stirnschneidend
not face cutting

Abbildung = rechtsschneidend
Picture = right hand cutting version

Bestellnummer Part number	System System	SW	Z	Ds	d ₃	l ₃	l ₂	d ₁		AN2P
DGFF.3.10.45.00	DG10	8	3	10	9,8	16,8	4,0	2		▲
DGFF.4.10.45.00	DG10	8	4	10	9,8	16,8	4,5	1		▲
DGFF.3.12.45.00	DG12	10	3	12	11,7	19,3	5,0	2		▲
DGFF.4.12.45.00	DG12	10	4	12	11,7	19,3	5,5	1		▲
DGFF.3.16.45.00	DG16	13	3	16	15,6	24,8	7,0	2		▲
DGFF.6.16.45.00	DG16	13	6	16	15,6	24,8	7,5	1		▲

▲ ab Lager / on stock Δ 4 Wochen / 4 weeks x auf Anfrage / upon request

● empfohlen / recommended

o bedingt einsetzbar / alternative recommendation

- nicht geeignet / not suitable

■ unbeschichtete HM-Sorten / uncoated grades

■ beschichtete HM-Sorten / coated grades

■ bestückt/Cermet / brazed/Cermet

Abmessungen in mm

Dimensions in mm

P	●
M	●
K	○
N	○
S	○
H	○

HM-Sorten
Carbide grades



Schnittdaten DGFF

Cutting Data DGFF

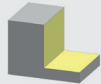
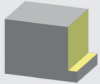

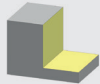
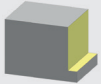
	 vc = m/min	 vc = m/min
P1.1	140	170
P1.2	140	170
P1.3	130	160
P2.1	120	140
P2.2	120	140
P2.3	120	140
P3.1	100	120
P3.2	90	110
M1.1	80	100
M2.1	60	70
M3.1	50	60

	 vc = m/min	 vc = m/min
K1.1	120	140
K1.2	100	120
K2.1	100	120
K2.2	90	110
K3.1	70	80
K3.2	60	70
S1	55	70
S2	40	50
S3	30	40
-	-	-
-	-	-

d ₁						
	f _z	a _e	a _p	f _z	a _e	a _p
10	0,05	2,5	2,5	0,14	0,25	0,25
10	0,04	2,5	2,5	0,10	0,25	0,25
12	0,05	3,0	3,0	0,15	0,30	0,30
12	0,04	3,0	3,0	0,11	0,30	0,30
16	0,06	4,0	4,0	0,18	0,40	0,40
16	0,04	4,0	4,0	0,10	0,40	0,40

Abmessungen in mm
Dimensions in mm



Viertelrund-Profilfräsen

Corner Rounding



Schneidkopf

Cutter Head

DGV

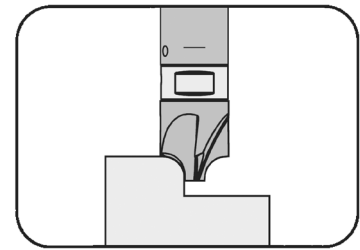

Radius konkav Radius concave 0,2-3 mm

für Fräaserschaft
for Milling shank

Typ MDG
Type

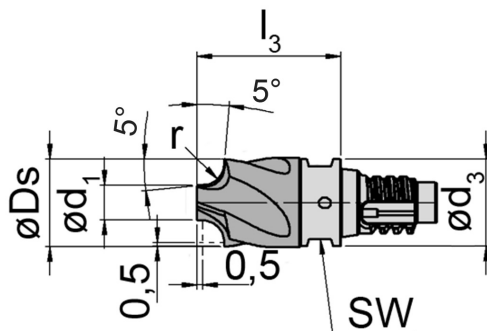

nicht stirnschneidend
not face cutting

Abbildung = rechtsschneidend
Picture = right hand cutting version

Bestellnummer Part number	System System	SW	Z	Ds	d ₃	r	l ₃	d ₁	AN2P
DGV.4.10.R020.00	DG10	8	4	10	9,8	0,20	16,8	8,6	▲
DGV.4.10.R050.00	DG10	8	4	10	9,8	0,50	16,8	8,0	▲
DGV.4.10.R100.00	DG10	8	4	10	9,8	1,00	16,8	7,0	▲
DGV.4.10.R125.00	DG10	8	4	10	9,8	1,25	16,8	6,5	▲
DGV.4.10.R150.00	DG10	8	4	10	9,8	1,50	16,8	6,0	▲
DGV.4.10.R200.00	DG10	8	4	10	9,8	2,00	16,8	5,0	▲
DGV.4.10.R250.00	DG10	8	4	10	9,8	2,50	16,8	4,0	▲
DGV.4.10.R300.00	DG10	8	4	10	9,8	3,00	16,8	3,0	▲

▲ ab Lager / on stock Δ 4 Wochen / 4 weeks x auf Anfrage / upon request

● empfohlen / recommended

o bedingt einsetzbar / alternative recommendation

- nicht geeignet / not suitable

■ unbeschichtete HM-Sorten / uncoated grades

■ beschichtete HM-Sorten / coated grades

■ bestückt/Cermet / brazed/Cermet

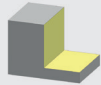
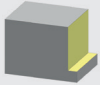

P	●
M	●
K	○
N	○
S	○
H	○

HM-Sorten
Carbide grades

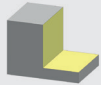
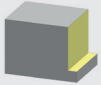
		
	vc = m/min	vc = m/min
P1.1	140	170
P1.2	140	170
P1.3	130	160
P2.1	120	140
P2.2	120	140
P2.3	120	140
P3.1	100	120
P3.2	90	110
M1.1	80	100
M2.1	60	70
M3.1	50	60

		
	vc = m/min	vc = m/min
K1.1	120	140
K1.2	100	120
K2.1	100	120
K2.2	90	110
K3.1	70	80
K3.2	60	70
S1	55	70
S2	40	50
S3	30	40
-	-	-
-	-	-



d ₁						
	f _z	a _e	a _p	f _z	a _e	a _p
10	0,08	0,20	0,20	0,10	0,24	0,24
10	0,07	0,50	0,50	0,10	0,25	0,25
10	0,06	1,00	1,00	0,10	0,25	0,25
10	0,05	1,25	1,25	0,10	0,25	0,25
10	0,05	1,50	1,50	0,10	0,25	0,25
10	0,04	2,00	2,00	0,10	0,25	0,25
10	0,04	2,50	2,50	0,10	0,25	0,25
10	0,04	3,00	3,00	0,10	0,25	0,25

Abmessungen in mm
Dimensions in mm



Toodle-Schnelllaufspindeln

Toodle high speed spindle

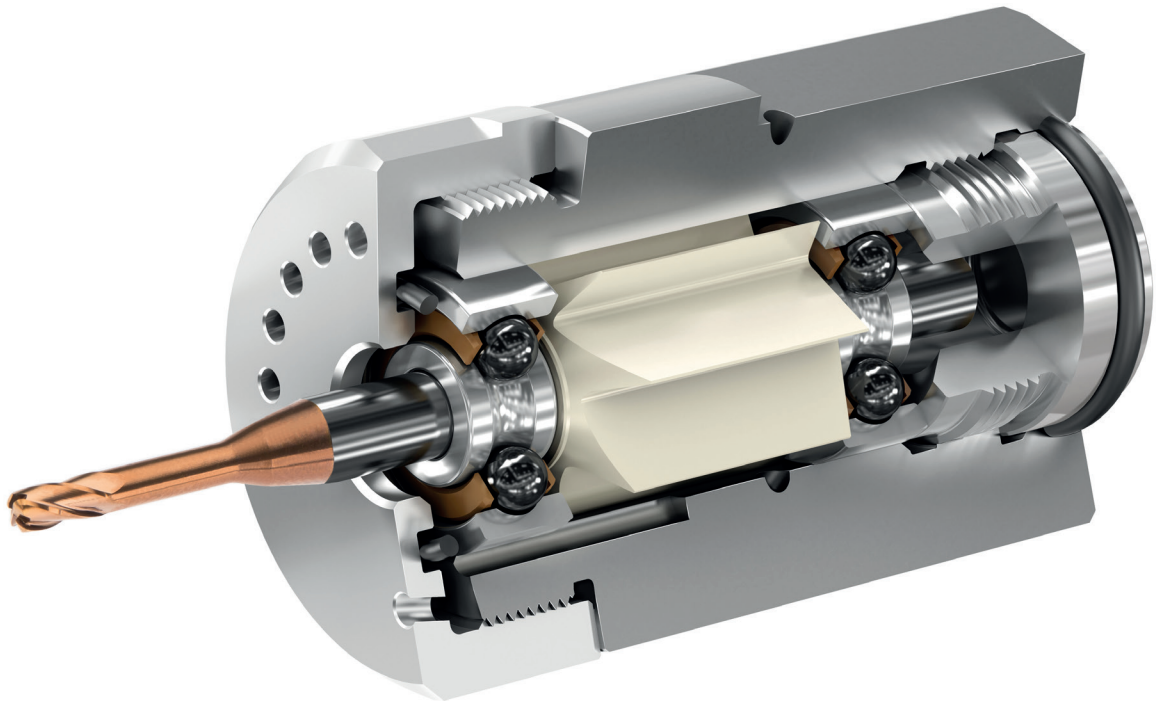

D

**Hochgenaues Fräsen von
0,1 - 3,0 mm Durchmesser,
für DS-Fräser**

**High-precision milling from
diameters of 0,1 - 3,0 mm,
for DS end mills**

Schnelllaufspindeln
High Speed Spindles
TB131 / TB131-90 /
TG131

Seite/Page
D4

Zubehör
Additional Equipment

Seite/Page
D5

Drehzahlen und
Kühlmitteldruck
Rotation Speed and
Coolant Pressure

Seite/Page
D6

Montageanleitung
Assembly Instruction

Seite/Page
D7

Über 600 Mikrofräser sind als Standard innerhalb einer Woche vormontiert lieferbar.
More than 600 Micro pre-mounted end mills are available as standard within one week.



Toodle-Schnelllaufspindeln für DS-Fräser

Mehr als 600 DS-Fräser mit Schneidkreisdurchmessern von 0,1 – 3 mm können mit vormontierter Toodle-Spindel innerhalb einer Woche geliefert werden. Dabei lassen sich die Fräser nicht nur hinsichtlich des Durchmessers auf den Bedarfsfall abstimmen. Dank der zahlreichen Varianten mit verschiedenen Geometrien, Beschichtungen und Hartmetallsubstraten kann das am besten geeignete Werkzeug zum Bearbeiten von NE-Metallen, Stählen, gehärteten Stählen, Titanlegierungen sowie anderen schwer zerspanbaren Werkstoffen ausgewählt werden.

Die Schnelllaufspindeln lassen sich problemlos in Standard-Werkzeugaufnahmen wie Hydrodehn-, Spannzangen- und Weldonfutter sowie in Bohrstangenhaltern spannen.

Toodle high-speed spindles for DS milling cutters

More than 600 DS milling cutters with cutting edge diameters of between 0.1 and 3 mm can be supplied with a pre-mounted Toodle spindle within one week. The milling cutters can be adapted to meet specific requirements more than simply in terms of their diameter. Thanks to the numerous versions with various geometries, coatings and carbide substrates, the tool best suited to the job can be selected for machining non-ferrous metals, steels, hardened steels, titanium alloys as well as other hard-to-cut materials.

The high-speed spindles can be clamped with ease in standard tool holders, such as hydraulic expansion chucks, collet chucks and Weldon shank adapters, as well as in boring bar holders.



TB131

Emulsion, Öl
Emulsion, Oil

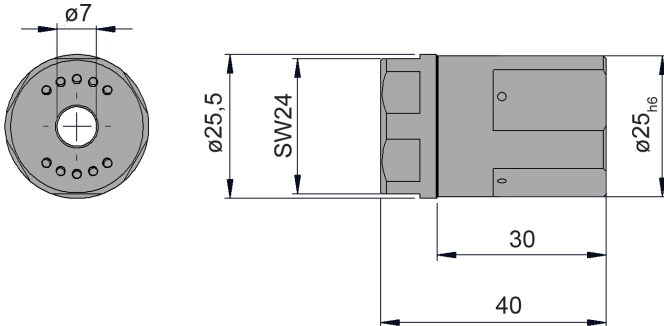

TB131-90

Emulsion, Öl
Emulsion, Oil

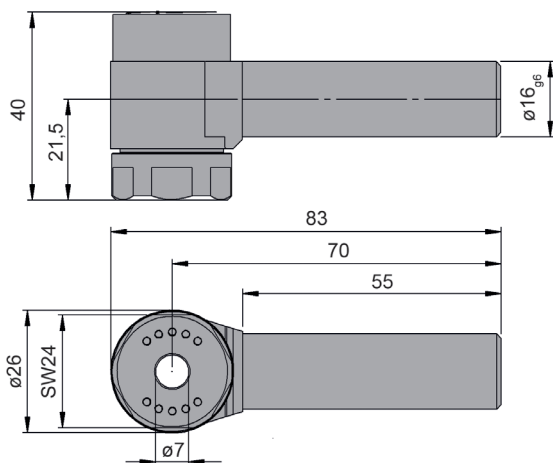

TG131

Druckluft geölt
Air mist

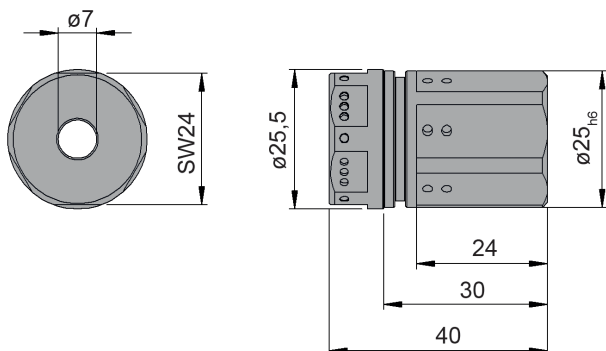

D

Austauschsatz
Assembly kit

Schaftdurchmesser
Shank diameter

RK13M3 Ø 3 mm
RK13M4 Ø 4 mm
RK13M6 Ø 6 mm



Montagesatz
Assembly kit

Schaftdurchmesser
Shank diameter

AK13M3 Ø 3 mm
AK13M4 Ø 4 mm
AK13M6 Ø 6 mm

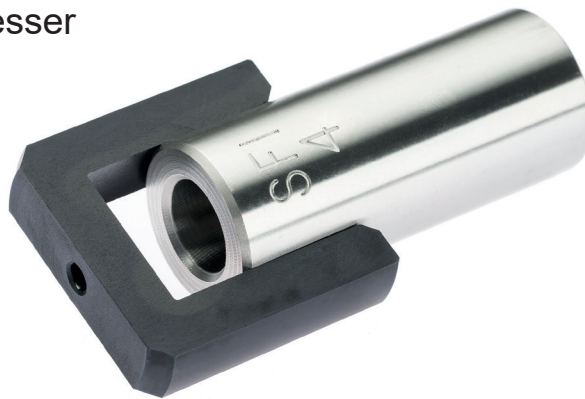

Druckmanometer
Pressure Manometer

PK25



D

Drehzahl / Kühlmitteldruck Toodle Blue TB131 & TB131-90

Rotation Speed / Emulsion Pressure

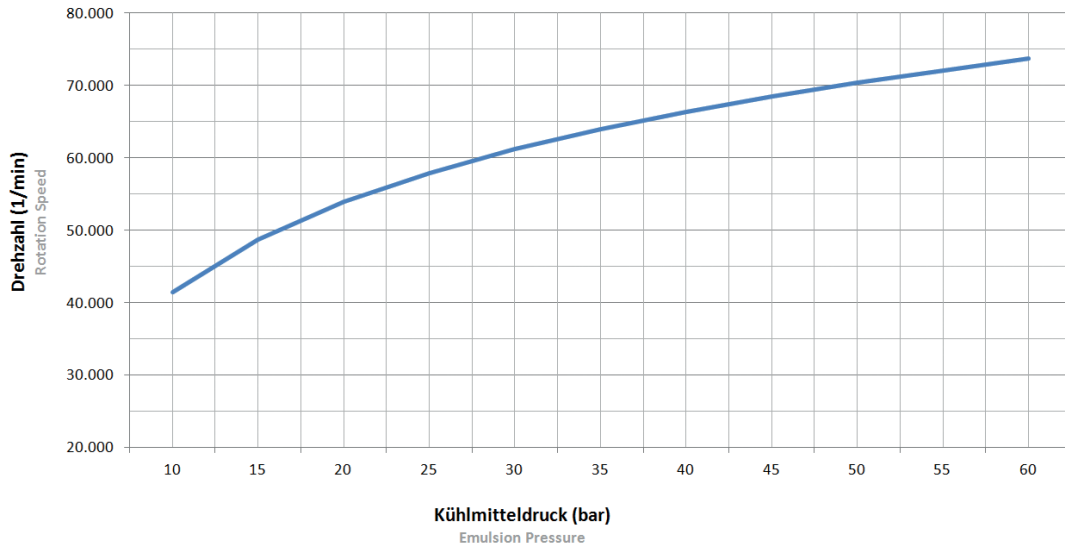

Drehzahl / Luftdruck Toodle Green TG131

Rotation Speed / Air pressure

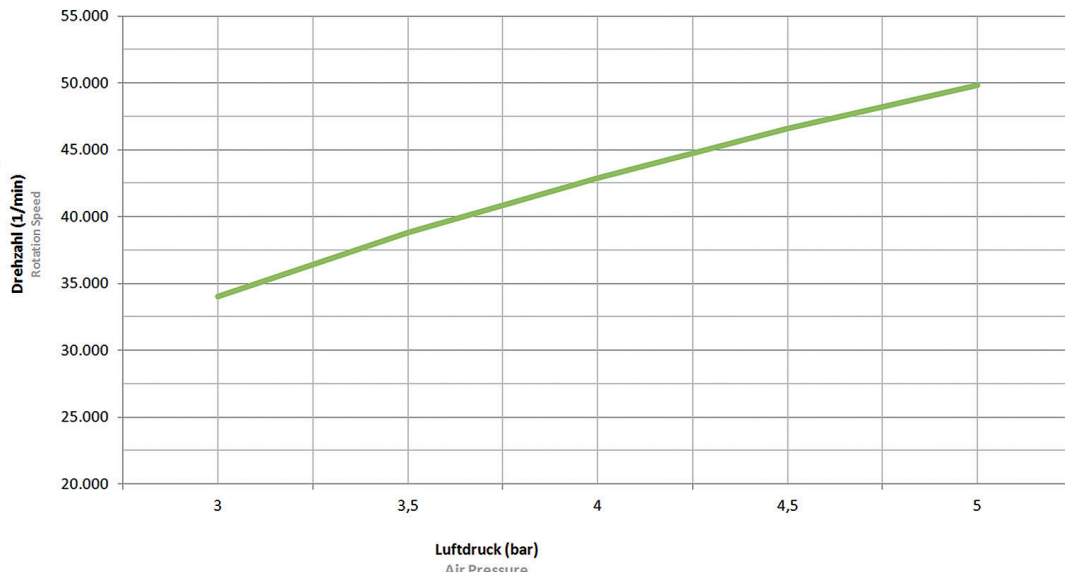

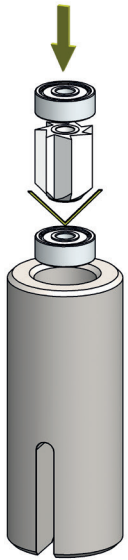

1.

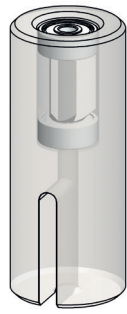

2.

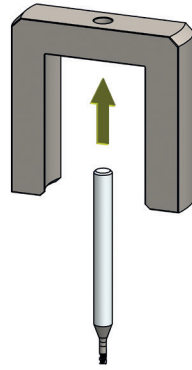

3.

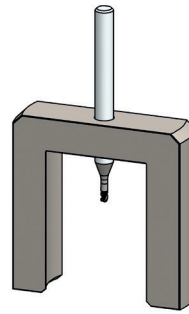

4.

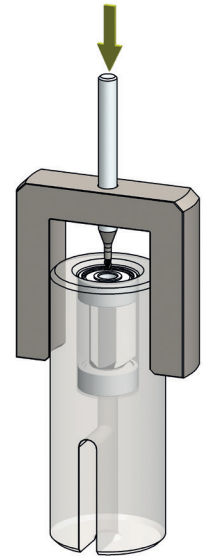

5.

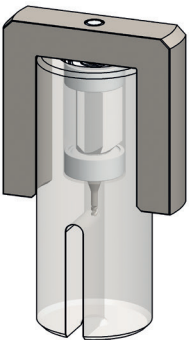

6.

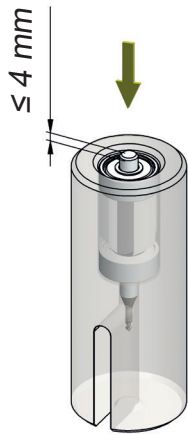

7.

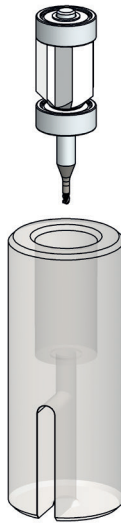

8.

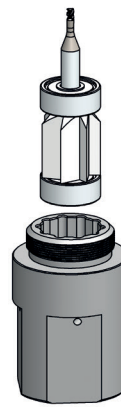

9.

5-10 Nm

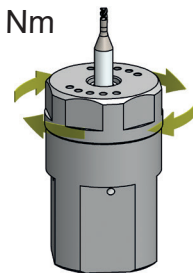

10.



Passende Spannmittel finden Sie un unserem Katalog
„Bohren und Reiben“.

For suitable toolholders please see our catalogue
„Drilling and Reaming“

EINSTECHEN • ABSTECHEN • NUTFRÄSEN • NUTSTOSSEN • KOPIERFRÄSEN • BOHREN • REIBEN

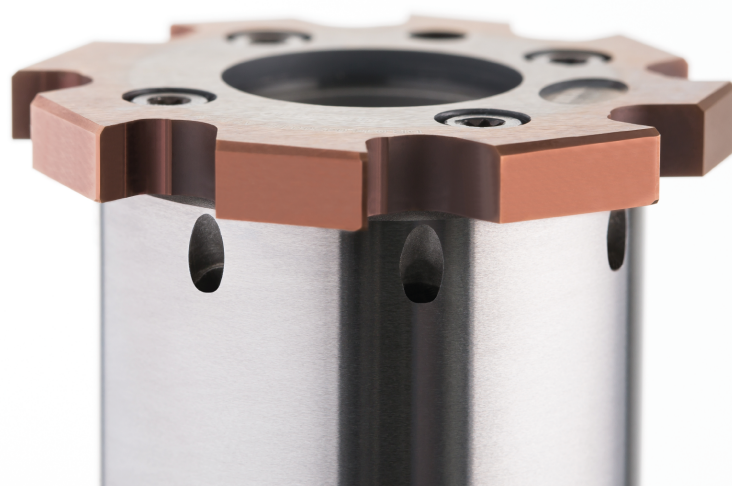

Bohren und Reiben
Drilling and Reaming

2018/2019

Schneidstoffgruppen nach DIN ISO 513

Cutting Material Groups per DIN ISO 513

Gruppen Main group	Symbol	Untergruppen Subgroups
Hartmetall Carbide	HW	unbeschichtetes Hartmetall auf WC-Basis uncoated carbides based upon WC
	HT	unbeschichtetes Hartmetall auf TiC/TiN-Basis (Cermets) uncoated carbides based upon TiC/TiN (Cermets)
	HF	Feinkornhartmetall micro grane carbides
	HC	beschichtetes Hartmetall / Cermets coated carbides / cermets
Schneidkeramik Ceramic cutting material	CA	Oxidkeramik auf Al_2O_3 -Basis Oxide ceramics based upon Al_2O_3
	CM	Mischkeramik auf Al_2O_3 + Metallcarbide Mixed ceramics based upon Al_2O_3 + metal carbide
	CN	Nitridkeramik auf Si_3N_4 -Basis Nitride ceramics based upon Si_3N_4
	CC	beschichtete Schneidkeramik Coated ceramics
Diamant Diamond	DM	Monokristalliner Diamant (MKD) Monocrystalline diamond (MCD)
	DP	Polykristalliner Diamant (PKD) Polycrystalline diamond (PCD)
Bornitrid Boron nitride	BN	Polykristallines, kubisches Bornitrid (CBN) Polycrystalline, cubic boron nitride (PCBN)

Technische Änderungen aufgrund von Weiterentwicklungen behalten wir uns vor.

Keine Gewähr für Druckfehler und Irrtümer.

Nachdruck, auch auszugsweise, nur mit unserer schriftlichen Genehmigung.

Stand: März 2018

Subject to technical changes developments.

No responsibility for errors or printer's errors accepted.

This catalogue may not be reprinted or photocopied in whole or in part without our written permission.

Edition: March 2018

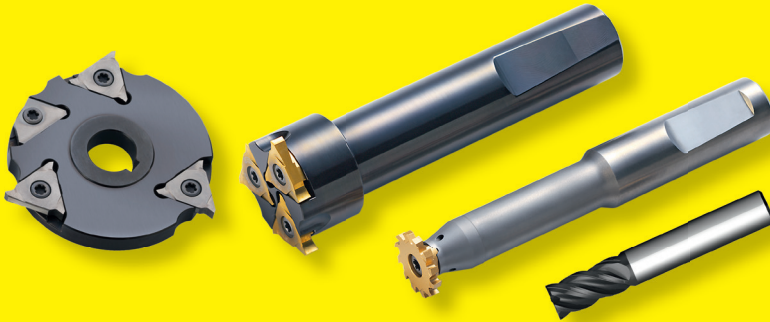

Deutschland / Germany

Hartmetall Werkzeugfabrik

Paul HORN GmbH

Unter dem Holz 33-35, D-72072 Tübingen

Tel +49 (0)7071/70040, Fax +49 (0)7071/72893

E-Mail: info@phorn.de, www.phorn.de

Großbritannien / UK and Ireland

HORN CUTTING TOOLS Ltd.

32 New Street, Ringwood, Hampshire,

BH24 3AD, Tel +44 (0)1425/481 800

Fax +44 (0)1425/481 888

E-Mail: info@phorn.co.uk, www.phorn.co.uk

Frankreich / France

HORN S.A.S

665, av. Blaise Pascal, Zone Industrielle,

77127 Lieusaint

Tel +33 (0)1648859-58, Fax +33 (0)1648860-49

E-Mail: infos@horn.fr, www.horn.fr

USA

HORN USA, Inc.

320 Premier Court, Suite 205, Franklin,

TN 37067

Tel +1 (888)818-HORN, Fax +1(615)771-4101

E-Mail: sales@hornusa.com, www.hornusa.com

Ungarn / Hungary

HORN Magyarország Kft.

H-9027 Győr, Gesztenyefa u. 4

Tel +36 96 55 05 31, Fax +36 96 55 05 32

E-Mail technik@phorn.hu, www.phorn.hu

China

HORN (Shanghai) Trading Co. Ltd.

Room 905, No. 518 Anyuan Road, P.R. of China

Putuo District, Shanghai 200060

上海市安远路518号905室 邮编: 200060

Tel.: +86 21 52833505; 52833205

Fax: +86 21 52832562

E-Mail: info@phorn.cn, www.phorn.cn

Mexico

HORN HERRAMIENTAS MÉXICO

Av. Hércules # 500 Bodega #8

Polígono Empresarial Sta. Rosa

Santa Rosa Jáuregui, Querétaro

C.P. 76220

Tel.: +442 291-0321, Fax: +442 291-0915

E-Mail: ventas@phorn.mx, www.phorn.mx

Russland / Russia

HORN RUS LLC

121059, Moscow

5 Bryanskaya street

Tel.: +7 (495) 968 21 68, Fax +7 (495) 960 21 68

E-Mail: info@hornrus.com, www.hornrus.com



BLUECOMPETENCE

Alliance Member

Partner of the Engineering Industry
Sustainability Initiative

TECHNOLOGIEVORSPRUNG IST HORN
HORN - EXCELLENCE IN TECHNOLOGY

